

2020 . V2.1



CONSTRULITA[®]
EL SENTIDO DE LA LUZ

GRUPO CONSTRULITA®

Trazamos un camino donde la luz es la esencia que nos dirige hacia un futuro deslumbrante. Hoy somos la fusión de dos prestigias compañías: Construlita y TecnoLite, y en conjunto llevamos luz a las personas que buscan trascender mediante soluciones innovadoras en iluminación tanto en el mercado profesional como en el residencial y comercial.

Nuestros centros de investigación y desarrollo de nuevos productos, así como la diversidad de soluciones en iluminación nos han posicionado como el grupo más importante de iluminación en México y Latinoamérica.

GRUPO CONSTRULITA, pone la luz en tus manos para que nunca dejes de brillar.

¡CONOCE NUESTRO SITIO WEB!



grupoconstrulita.com



CONSTRULITA®

CONSTRULITA es la marca **experta en iluminación profesional** en aplicaciones comerciales, oficinas, centros de servicio, industriales, hospitalidad, arquitectónicas, urbanas y de alumbrado público; satisfaciendo las necesidades de nuestros influenciadores de la iluminación mediante conocimiento, tecnología y generación de propuestas que agregan valor a los proyectos, creando espacios llenos de experiencias cautivadoras que aumentan tus sentidos mediante la luz.

Entendemos y anticipamos las necesidades del mercado mediante **la mejora continua, la creatividad y la innovación** de nuestro catálogo de productos y servicios.

Somos el aliado de los especialistas e influenciadores del segmento profesional, siempre asesorando, acompañando y apoyando sus proyectos a través de herramientas que facilitan la especificación de nuestros productos.

Nuestra oferta de soluciones se actualiza constantemente con la tecnología de punta de acuerdo a tendencias globales como dispositivos IoT y plataformas inteligentes.

Nuestro centro de manufactura en Querétaro tiene capacidad para diseñar soluciones a la medida y líneas de producción flexibles para servir oportunamente las necesidades de nuestros clientes.



grupoconstrulita.com

CONSTRULITA[®] LIGHTING AWARDS

Grupo Construlita, cada año reconoce el talento en la iluminación en América Latina.

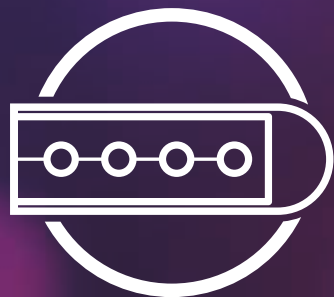

ILUMINACIÓN
ARQUITECTÓNICA



GRANDES
SUPERFICIES



DISEÑO DE
PRODUCTO

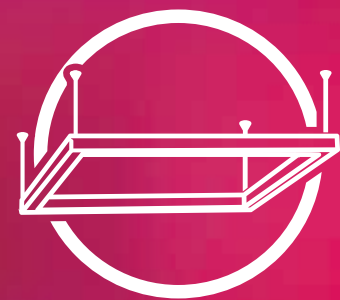

ILUMINACIÓN
INTERIOR



PAISAJISMO

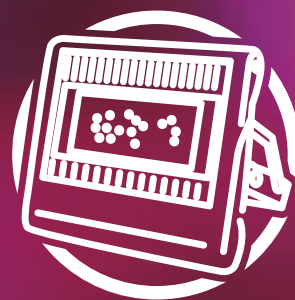

LIGHT-ART



CONCEPTUAL



GANADOR 2020



FAVORITO DEL PÚBLICO 2020



ILUMINACIÓN ARQUITECTÓNICA 2020



DISEÑO DE PRODUCTO 2020



ILUMINACIÓN INTERIOR 2020



PAISAJISMO 2020



CONCEPTUAL 2020



GRANDES SUPERFICIES 2020



¡Muestra tu talento!

www.construlitalighting.com/cla

*Las fotografías de proyectos son cortesía de los participantes.

Las nuevas generaciones son el motor de la industria de la iluminación que avanza al mismo ritmo que las nuevas tecnologías.

Hoy, la luz es reconocida como el elemento vital que forma parte de nuestras vidas y está presente en el arte, la educación, la ciencia, la tecnología y el diseño.

Sabemos lo importante que es reconocer el talento de quienes engrandecen los espacios a través del diseño de iluminación, por lo que somos el único concurso en México que premia lo mejor de la luz.

GRUPO
CONSTRULITA

CONSTRULITA
EL SENTIDO DE LA LUZ

tecnolite®
LA LUZ ES TUYA

ELA EXPO
LIGHTING
AMERICA

CENTRO DE MANUFACTURA

SOMOS ORGULLOSAMENTE MEXICANOS

Dentro de nuestros elementos fundamentales para fomentar la innovación y el liderazgo, se encuentra estratégicamente ubicado en la Cd. De Querétaro, el centro de excelencia en iluminación Construlita, con manufactura de clase mundial.



Contamos con un sistema de calidad con procesos certificados orientados a lograr la satisfacción de los requerimientos de nuestros clientes.

Nuestra filosofía de excelencia se compromete con la preservación de nuestros recursos naturales. Por ello, hemos decidido formar parte del **PROGRAMA NACIONAL DE AUDITORÍA AMBIENTAL**, método propuesto por la PROFEPA (Procuraduría Federal de Protección al Ambiente) para evaluar los procesos industriales respecto al medio ambiente. Gracias a esto, Construlita posee el certificado ambiental de Industria Limpia que garantiza que todos nuestros productos son elaborados con tecnología, calidad y responsabilidad ambiental.



DISEÑO Y DESARROLLO DE PRODUCTOS

Cada una de nuestras luminarias tiene detrás de sí el talento y compromiso de un equipo de desarrollo de producto.

A través de nuestro proceso de Diseño y Desarrollo de Nuevos Productos, ingenieros, diseñadores y profesionales de la luz, se unen para llevar a cabo la concepción de productos de última generación y las mejoras necesarias en nuestros productos actuales considerando los cambios tecnológicos y sus especificaciones iniciales.

NOS ADAPTAMOS A LAS NECESIDADES DE TU PROYECTO

Nos distingue la capacidad de personalizar las luminarias para tus proyectos, gracias a los siguientes subsistemas:

SISTEMA ELECTRÓNICO: Integración de módulos LEDs, drivers y sistemas de control.



SISTEMA MECÁNICO: Diseño estético y funcional del cuerpo del luminario así como de disipación de calor.

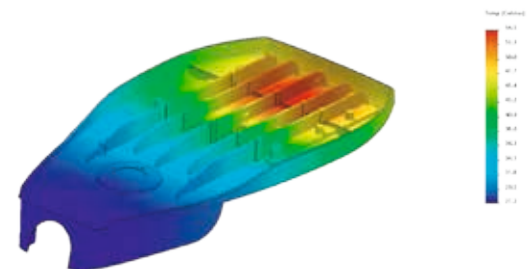

SISTEMA ÓPTICO: Desarrollo de reflectores y lentes asistidos por computadora para un óptimo control de la luz.

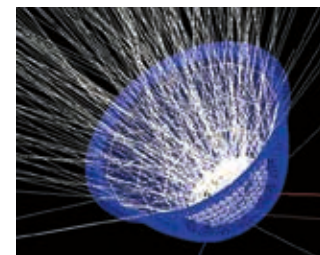

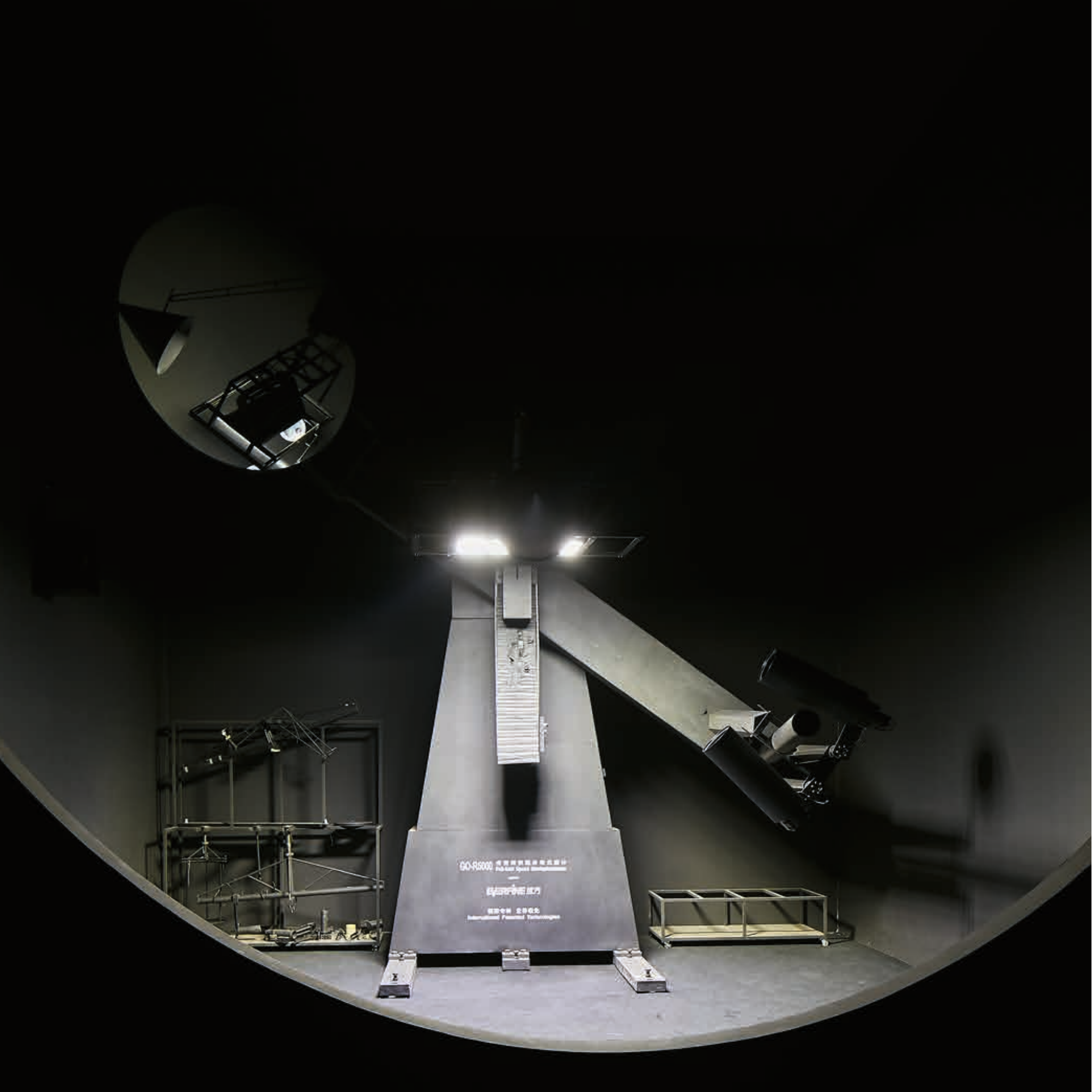

GO-R30000 中国航空工业集团公司
—
航空发动机研究所
—
北京航空发动机研究院
International Patent Technology



CONSTRULITA LAB

LABORATORIO DE PRUEBAS

Al interior del Centro de Excelencia Construlita, contamos con nuestro propio laboratorio de pruebas, conocido como **CONSTRULITA LAB**, a través del cual garantizamos la calidad de nuestros productos y el cumplimiento de las normas aplicables.

En este espacio, nuestros ingenieros cuentan con un equipo de medición que evalúa y garantiza el óptimo funcionamiento de nuestras luminarias.

•FOTOGONIÓMETRO

Mide la distribución de la luz, intensidad y flujo luminoso.

•ESFERA INTEGRADORA

Necesaria para obtener el espectro cromático luminoso, de acuerdo al diafragma CIE.

•CÁMARA DE HUMEDAD Y TEMPERATURA

Realizamos pruebas de envejecimiento.

•FUENTE PROGRAMABLE DE C.A.

Controla la corriente eléctrica de alimentación y somete el luminario a ruido eléctrico (armónicos).

•CÁMARA DE NIEBLA SALINA

La prueba de durabilidad más efectiva ante ambientes corrosivos

•CÁMARA DE PRUEBA DE LLUVIA

Verifica la hermeticidad del luminario de exterior para determinar el grado de protección en exterior.

•CÁMARA DE HILO INCANDESCENTE

Mide la inflamabilidad de los componentes plásticos.

•ANALIZADOR DE POTENCIA

Establece la demanda de energía eléctrica del luminario, su potencia y consumo.



NOM



PAESE
Programa de Ahorro de Energía del
Sector Eléctrico



ASESORAMOS TUS PROYECTOS

DESARROLLO DE PROYECTOS DE ILUMINACIÓN.

Estamos preparados para asumir nuevos retos y ser tu apoyo profesional con nuestro equipo de expertos para llevar cada proyecto a su máxima eficiencia.

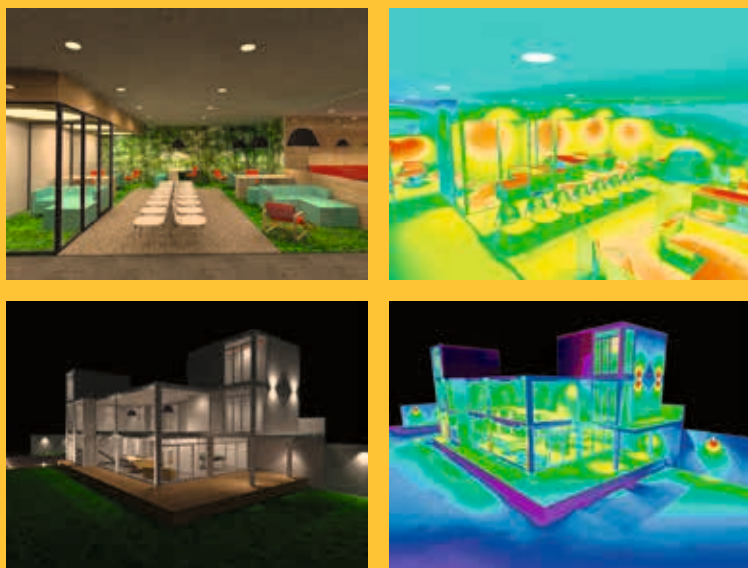

Contamos con un departamento de apoyo a los proyectos de iluminación a través de:

- Curva IES
- Fichas técnicas
- Recomendaciones de producto
- Asesoría técnica y estética.

Contáctanos

solicitud.proyectos@construlita.com.mx

QRO 442 238 3900



CONSULTA NUESTRA
RED DE ESPECIALISTAS





SOLUCIONES DMX

INNOVACIÓN EN CONTROL DE ILUMINACIÓN

La combinación de iluminación y protocolos de comunicación han abierto un abanico infinito de posibilidades a la hora de diseñar y personalizar la iluminación en espacios arquitectónicos. Actualmente, es casi vital que una fachada o monumento emblemático cuente con un sistema de iluminación dinámico capaz de controlarse y adaptarse a las distintas necesidades de funcionamiento y comunicación que tenga el recinto.

El Control DMX es un protocolo utilizado en iluminación que habilita la comunicación entre los luminarios y el software de control.

Un luminario o equipo de iluminación puede contar con distintos niveles de integración de la tecnología DMX. Es decir, existen equipos que no son compatibles con este protocolo; otros, aunque son compatibles requieren de accesorios o decodificadores para poder funcionar correctamente; los equipos totalmente compatibles tienen conexión directa con el protocolo, pues este ya se encuentra integrado en su controlador.

La gran facilidad de conectividad y control que tienen estos equipos permite múltiples alternativas de personalización al momento de iluminar un espacio. Cambiar de temperatura, atenuar y variar el color en la luz, son algunas de las posibilidades que brinda el protocolo DMX, el cual puede manejarse desde un teléfono móvil o computadora a través de la aplicación **Arcolis**.

En **CONSTRULITA** encontrarás equipos con protocolo DMX totalmente integrado, ideales para iluminar espacios arquitectónicos exteriores y fachadas (página 143), que además cuentan con un alto índice de protección de ingreso (IP66) y alto índice de protección contra impactos mecánicos (IK9).

**LA INTEGRACIÓN DE SISTEMAS DMX,
PERMITE MÚLTIPLES ALTERNATIVAS
DE PERSONALIZACIÓN**

NOMENCLATURA

OF 1 004 B BC A

CONSECUTIVO

SEGMENTO

CO	Comercial
OF	Oficinas y Corporativos
IN	Industrial y Grandes superficies
RE	Residencial, Hospitalidad, Servicios y Diseño
OU	Urbano y Arquitectónico
AC	Accesorios y Equipos
MT	Magnetic Track

INSTALACIÓN

0	Sobreponer
1	Empotrar Techo
2	Empotrar Muro
3	Empotrar Piso
4	Sobreponer Techo
5	Sobreponer Tiet
6	Sobreponer Muro
7	Sobreponer Piso
8	Suspendido
9	Poste / Punta Poste

COLOR LUMINARIO

A	Amarillo
B	Blanco
C	Café
D	Dorado
F	Grafito
G	Gris
N	Negro
R	Rojo
S	Satinado
V	Verde
Z	Azul

TEMPERATURA DE COLOR Y TECNOLOGÍA

00	Sin Lámpara
21	Cálido/HD
26	Master City White
27	Cálido Fluorescente
28	Cosmopolis
29	Cálido/Halógeno
30	Neutro/HD
41	Neutro/Fluorescente
42	Frío/HD
65	Frío/Fluorescente

VOLTAJE DE ALIMENTACIÓN

A	127-277 V-
B	127-220 V-
C	277 V-
D	127 V-
E	220 V-
F	12 Vcd
G	24 Vcd
H	127/220/254/277 V-
I	127/220/240 V-
J	220/277 V-
K	Sin Equipo
L	127/277 V-
Q	127-277 V- Lutron
S	127-277 V- y Sensor
V	42 V-
P	7.4 Vcd

URBANO Y VIALIDADES

V1 060 UN 1M 50

INSTALACIÓN

V1	Vialidades 1
V2	Vialidades 2
V3	Vialidades 3
V4	Vialidades 4
V5	Vialidades 5
M1	Metroled

POTENCIA DE LÍNEA

035	33-37 W
040	37.5-42.5 W
055	52-58 W
065	65-67.4 W
070	66.5-73.5 W
075	72.5-75 W
080	76-84 W
095	90-100 W
110	103.5-116.5 W
125	118-132 W
140	133-145 W
150	146-154.5 W
160	155-164 W
170	165-175 W
185	176-193 W
200	194-209 W
220	210-230 W
240	231-250 W

ALIMENTACIÓN

HV	240-480 V-
LV	12/24 Vcd
UN	100-300 V-

CURVA

2C	Tipo II Corta
3C	Tipo III Corta
5C	Tipo V Corta
2L	Tipo II Larga
3L	Tipo III Larga
5L	Tipo V Larga
2M	Tipo II Media
3M	Tipo III Media
5M	Tipo V Media

TEMPERATURA DE COLOR (K)

27	2580 - 2870
30	2870 - 3220
35	3220 - 3710
40	3710 - 4260
45	4260 - 4746
50	4745 - 5311
57	5310 - 6020
65	6020 - 7040

CONTENIDO



INTERIOR

LUMINARIOS DE TECHO	p. 19
PEDESTAL	p. 55
MAGNETRACK LINE	p. 57
LUMINARIOS DE RIEL	p. 61
DECORATIVO	p. 71
LINEAL	p. 93
PANEL LED	p. 103
GABINETES OFICINA	p. 107
TIRA LED	p. 111
COLGANTE COMERCIAL	p. 115
LUZ DE SEGURIDAD	p. 117
INDUSTRIAL	p. 119
INDUSTRIAL UFO	p. 127
INDUSTRIAL LINEAL	p. 131
A PRUEBA DE HUMEDAD	p. 133

EXTERIOR

MOONLIGHT	p. 139
DMX	p. 143
ACABADO BRONCE	p. 147
WALL PACK	p. 151
ARBOTANTE	p. 155
MARKO	p. 159
CORTESÍA MURO	p. 161
POSTE DECORATIVO	p. 167
MINI POSTE	p. 169
LUMINARIOS DE PISO	p. 173
BOYA	p. 183
SUMERGIBLE	p. 185
ILUMINACIÓN DE JARDÍN	p. 187
BARRA	p. 191
ESTACIONES DE SERVICIO	p. 197
LINEAL URBANO	p. 199
ALUMBRADO PÚBLICO	p. 201
URBANO	p. 207
PROYECTOR MODULED	p. 213

LÁMPARAS & ACCESORIOS

p. 217

CÓDIGO	PÁG	CÓDIGO	PÁG	CÓDIGO	PÁG	CÓDIGO	PÁG	CÓDIGO	PÁG
42636	218	AC4253BBCA	94	AC5521N	60	CO1024BBNA	22	CO1172NBCA	35
42637	218	AC4253BBNA	225	AC5521N	223	CO1040BBNA	22	CO1176NBCA	35
42752	218	AC4253BBNA	94	AC5530N	60	CO1055BBCB	36	CO1183BBCD	31
42753	218	AC4253BBNA	225	AC5530N	223	CO1055NBCB	36	CO1185BBCA	34
42800	218	AC4253NBCA	94	AC5531N	60	CO1056BBCB	36	CO1186BBCA	34
42801	218	AC4253NBCA	225	AC5531N	223	CO1056NBCB	36	CO1187BBCA	34
AC1068N	32	AC4253NBNA	94	AC6036B	227	CO1057BBCB	36	CO1188BBCA	34
AC1072B	219	AC4253NBNA	225	AC6037B	227	CO1057NBCB	36	CO1200BBCA	21
AC1072N	219	AC4256S	226	AC6038N	227	CO1058BBCB	36	CO1200BBFA	21
AC1073B	219	AC5001B	221	AC6039B	227	CO1058NBCB	36	CO1200BBNA	21
AC1073N	219	AC5001N	221	AC6040B	227	CO1060BBCB	43	CO1214BBCA	21
AC1074B	219	AC5002B	221	AC6042B	227	CO1060BBFA	43	CO1214BBFA	21
AC1074N	219	AC5002N	221	AC6043B	227	CO1066BBFA	43	CO1214BBNA	21
AC1075B	219	AC5003B	221	AC6200S	226	CO1074BBCB	43	CO1216BBCA	22
AC1075N	219	AC5003N	221	AC6201	227	CO1074BBFA	43	CO1216BBNA	22
AC1077B	219	AC5040B	221	AC6210S	226	CO1082BBCA	44	CO1230BBCA	54
AC1189N	219	AC5040N	221	AC6211	227	CO1082NBCA	44	CO1230NBCA	54
AC1255S	225	AC5041B	221	AC6800	224	CO1083BBCA	44	CO1231BBCA	54
AC1256S	225	AC5041N	221	AC6801	221	CO1083NBCA	44	CO1231NBCA	54
AC2200S	226	AC5050N	220	AC6802	221	CO1084BBCA	44	CO1232BBCA	54
AC2201	227	AC5051B	220	AC6803	221	CO1084NBCA	44	CO1232NBCA	54
AC3200S	226	AC5052B	220	AC7002N	228	CO1085BBCA	44	CO1245BBNB	28
AC3201	226	AC5054N	220	AC7018B	228	CO1085NBCA	44	CO1246BBNB	28
AC3209	227	AC5055N	220	AC7050N	228	CO1086BBCA	50	CO1260BBCA	45
AC3211S	226	AC5056N	220	AC7100S	228	CO1087BBCA	50	CO1261BBCA	45
AC3212	227	AC5090N	222	AC7105S	228	CO1088BBCA	50	CO1262BBCA	45
AC4013N	224	AC5091N	222	AC7106S	228	CO1091BBNA	99	CO1263BBCA	45
AC4040N	224	AC5092N	222	AC7107S	228	CO1091NBNA	99	CO1264NBCA	46
AC4041N	224	AC5093N	222	AC7108S	228	CO1094BBCA	47	CO1265NBCA	46
AC4050B	220	AC5096N	222	AC7109S	228	CO1095BBCA	47	CO1266NBCA	46
AC4050N	220	AC5097N	222	AC7110S	228	CO1096BBCA	47	CO1267NBCA	46
AC4091B	219	AC5430B	222	AC7200S	228	CO1097BBCA	47	CO1270BBCA	49
AC4092B	219	AC5430N	222	AC7300N	229	CO1098BBCA	47	CO1270NBCA	49
AC4093B	219	AC5431B	222	AC7505g	228	CO1099BBCA	47	CO1271BBCA	49
AC4096B	219	AC5431N	222	AC7515B	228	CO1101BBCB	48	CO1271NBCA	49
AC4097B	219	AC5432B	222	AC7525B	228	CO1102BBCB	48	CO1300BBCA	21
AC4098B	219	AC5432N	222	AC8090N	229	CO1103BBCB	48	CO1300BBFA	21
AC4251BBCA	94	AC5433B	222	AC8091N	229	CO1104BBCB	48	CO1300BBNA	21
AC4251BBNA	225	AC5433N	222	AC8092N	229	CO1105BBCB	48	CO1625BBCA	32
AC4251BBNA	94	AC5501N	60	AC8093N	229	CO1106BBCB	48	CO1625BBCB	32
AC4251BBNA	225	AC5501N	223	AC8101BBNA	224	CO1110NBCB	41	CO1625BBNA	32
AC4251NBCA	94	AC5502N	60	AC8102BBNA	224	CO1111NBCB	41	CO1625BBNB	32
AC4251NBCA	225	AC5502N	223	AC8103BBNA	224	CO1137BBCA	33	CO1629NBCA	32
AC4251NBNA	94	AC5503N	60	AC8110N	224	CO1148BBCA	29	CO1629NBCB	32
AC4251NBNA	225	AC5503N	223	AC8111N	224	CO1149BBCA	29	CO1629NBNA	32
AC4252BBCA	94	AC5510N	60	AC8200S	226	CO1150BBNA	33	CO1629NBNA	32
AC4252BBNA	225	AC5510N	223	AC8201S	226	CO1161BBCB	40	CO1629NBNA	32
AC4252BBNA	94	AC5511N	60	AC8202	227	CO1161NBCB	40	CO1634NBCB	30
AC4252BBNA	225	AC5511N	223	AC8203	227	CO1162BBCA	32	CO1634NBNA	30
AC4252NBCA	94	AC5512N	60	AC8254S	94	CO1162BBCB	32	CO1635NBCA	30
AC4252NBCA	225	AC5512N	223	AC8254S	225	CO1162NBCA	32	CO1635NBCB	30
AC4252NBNA	94	AC5520N	60	AC8312B00K	224	CO1162NBCB	32	CO1635NBNA	30
AC4252NBNA	225	AC5520N	223	CO1024BBNA	22	CO1171NBCA	35	CO1636NBCB	30
								CO1637NBCA	31

CÓDIGO	PÁG	CÓDIGO	PÁG	CÓDIGO	PÁG	CÓDIGO	PÁG	CÓDIGO	PÁG
CO1638NBCA	31	CO5094NBCB	62	IN1955BBFA	198	IN8850BBFA	132	MT4002NBCV	59
CO1639NBCA	31	CO5095NBCB	62	IN4030GBNA	135	IN8850NBFA	132	MT4003NBCV	59
CO1739NBCA	31	CO5096NBCB	62	IN4032GCCA	134	IN8851BBFA	132	MT5001NBCV	60
CO4023BBNA	51	CO5105BBCA	67	IN4041BBNA	136	IN8851NBFA	132	MT5002NBCV	60
CO4025BBNA	51	CO5105NBCA	67	IN4043GBNB	135	IN8853BBFA	120	MT5003NBCV	60
CO4040SBCF	102	CO5110BBCA	66	IN4044GBNB	135	IN8854BBFA	120	MT5010NBCV	58
CO4041SBCF	102	CO5110NBCA	66	IN4045GBNB	135	IN8855BBFA	120	MT5011NBCV	58
CO4042SBCF	102	CO5112BBCA	62	IN4338BBNA	135	IN8905NBFA	120	MT5012BBCV	58
CO4080BBCA	53	CO5112NBCA	62	IN4607BBFA	121	IN8906NBFA	120	MT5020BBCV	58
CO4080NBCA	53	CO5113BBCA	62	IN4608BBFA	121	ML4210SBFAO	216	MT5021BBCV	58
CO4081BBCA	53	CO5113NBCA	62	IN4609BBFA	121	ML4420SBFAO	216	MT6001NBCV	59
CO4081NBCA	53	CO5250BBCA	65	IN4610BBFA	121	ML4630SBFAO	216	MT6002NBCV	59
CO4082BBCA	53	CO5250NBCA	65	IN4800BBFA	122	ML6210NBFCW	215	MT8001NBCV	60
CO4082NBCA	53	CO5251NBCA	65	IN4955BBFA	198	ML6315NBFCO	215	MT8002NBCV	60
CO4083NBCA	51	CO5252NBCA	65	IN8006SBFB	129	ML6315NBFCW	215	MT8003NBCV	60
CO4084NBCA	51	CO5253BBCA	65	IN8007BBCA	129	ML6630NBFCM	214	OF1004BBNA	110
CO4090BBCA	101	CO5255BBCA	65	IN8007BBFA	129	ML6630NBFCM	214	OF1014BBNA	109
CO4090NBCA	101	CO5255NBCA	65	IN8007BBNA	129	ML6630NBFCN	214	OF1021BBNA	109
CO4091BBNA	101	CO5256BBCA	65	IN8007NBNA	129	ML6630NBFCO	214	OF1022BBNA	109
CO4091NBNA	101	CO5257BBCA	65	IN8025BBNA	123	ML6630NBCK	214	OF1038BBNA	108
CO5039BBBCB	67	CO5258BBCA	65	IN8026BBNA	123	ML6630NBNCM	214	OF1039BBNA	108
CO5039NBCB	67	CO5258NBCA	65	IN8027BBNA	123	ML6630NBNCN	214	OF1040BBNA	108
CO5050BBCA	65	CO5667NBCA	68	IN8028NBFA	128	ML6630NBSCO	214	OF1050BBNA	102
CO5050NBCA	65	CO6091BBNA	101	IN8029NBFA	128	ML6C60NBFCM	214	OF1052BBNA	99
CO5051BBCA	65	CO6314BBFL	118	IN8030NBFA	128	ML6C60NBFCM	214	OF1052NBNA	99
CO5051NBCA	65	CO6315BVEL	118	IN8200BBFA	124	ML6C60NBFCN	214	OF1053BBNA	99
CO5052BBCA	65	CO6316BVEL	118	IN8208BBFA	123	ML6C60NBFCO	214	OF1053BBNA	99
CO5052NBCA	65	CO6620NBCA	54	IN8209BBFA	123	ML6C60NBCK	214	OF1070BBNA	108
CO5062BBCA	68	CO6620NBFA	54	IN8209BBNA	123	ML6C60NBNCM	214	OF1097BBNB	105
CO5062NBCA	68	CO6620NBNA	54	IN8210BBFA	123	ML6C60NBNCN	214	OF1097BCFB	105
CO5065BBBCB	64	CO7000NBCB	56	IN8210BBNA	123	ML6C60NBSCO	214	OF1098BBBCB	105
CO5065NBCB	64	CO7001NBCB	56	IN8211BBFA	124	ML6K80NBFCM	215	OF1098BBNB	105
CO5066NBCD	64	CO8040BBNA	116	IN8212BBFA	124	ML6K80NBFCM	215	OF1099BBNB	105
CO5068BBCD	67	CO8041BBNA	116	IN8212BBNA	124	ML6K80NBFCN	215	OF1105BBNA	110
CO5068NBCD	67	CO8041NBNA	116	IN8213BBNA	124	ML6K80NBFCO	215	OF1106BBFA	109
CO5069BBCA	67	CO8041RBNA	116	IN8214BBFA	125	ML6K80NBCK	215	OF1106BBFA	110
CO5069NBCA	67	CO8089BCNA	97	IN8215BBFA	125	ML6K80NBNCM	215	OF1297BBNA	104
CO5070BBCA	69	CO8089NCNA	97	IN8215BBNA	125	ML6K80NBNCN	215	OF1321BBNA	109
CO5070NBCA	69	CO8090BCNA	97	IN8216BBFA	125	ML6K80NBSCO	215	OF1340BBNA	108
CO5071NBCA	69	CO8090NCNA	97	IN8216BBNA	125	ML6S12NBFCM	215	OF1833BBNA	108
CO5071NBCA	69	CO8091BBNA	95	IN8217BBFA	126	ML6S12NBFCM	215	OF4027BBNA	136
CO5074BBCA	64	CO8091NBNA	95	IN8218BBFA	126	ML6S12NBFCN	215	OF4038BBFA	136
CO5075BBBCD	64	CO8092BBNA	97	IN8218BBNA	126	ML6S12NBFCO	215	OF4047BBNA	99
CO5075NBCD	64	CO8092NBNA	97	IN8219BBFA	126	ML6S12NBCK	215	OF4048BBNA	102
CO5076NBCA	64	CO8095BBNA	95	IN8219BBNA	126	ML6S12NBNCM	215	OF4048NBNA	102
CO5080BBCA	63	CO8102BBNA	96	IN8846BBFA	132	ML6S12NBNCN	215	OF4049BBNA	99
CO5080BBCA	63	CO8102NBNA	96	IN8846NBFA	132	ML6S12NBSCO	215	OF4106BBFA	110
CO5082BBCA	63	CO8104BBNA	96	IN8847BBFA	132	ML8420NBFCN	214	OF4138BBNA	136
CO5082NBCA	63	CO8104NBNA	96	IN8847NBFA	132	ML8420NBFCO	214	OF4206BBCD	100
CO5083BBCA	63	CO8110NBNA	95	IN8848BBFA	132	MT1001NBCV	59	OF4206BBFD	100
CO5083NBCA	63	CO8111NBNA	95	IN8848NBFA	132	MT1002NBCV	59	OF4206BBND	100
CO5085BBCA	67	IN1120BBNA	104	IN8849BBFA	132	MT1003NBCV	59	OF4209BBCD	100
CO5085NBCA	67	IN1121BBNA	104	IN8849NBFA	132	MT4001NBCV	59	OF4209BBFD	100

CÓDIGO	PÁG	CÓDIGO	PÁG	CÓDIGO	PÁG	CÓDIGO	PÁG	CÓDIGO	PÁG
OF4209BBND	100	OU3042GBFA	184	OU3402GLJA	141	OU3705SBCA	181	OU6802NBFA	152
OF4212BBCD	100	OU3044NBFB	178	OU3402GLVA	141	OU4090FBCB	158	OU6803SBFA	152
OF4212BBFD	100	OU3048NBCB	178	OU3403GLAA	141	OU4090FBNB	158	OU7012C00K	148
OF4212BBND	100	OU3050NBFB	178	OU3403GLJA	141	OU6011GBFA	195	OU7013C00K	150
OF4218BBCD	100	OU3051NBFB	179	OU3403GLVA	141	OU6012SBCF	162	OU7014C00K	150
OF4218BBFD	100	OU3057NBFA	179	OU3404SLAA	140	OU6013SBCF	162	OU7020NBFA	188
OF4218BBND	100	OU3059NBFA	179	OU3404SLJA	140	OU6014SBCF	162	OU7021NBFA	188
OF4224BBCD	100	OU3059NBFA	179	OU3404SLVA	140	OU6023GAA	193	OU7022NBFA	188
OF4224BBFD	100	OU3074NAMA	178	OU3405SLAA	140	OU6023GBCA	193	OU7023NBFA	188
OF4224BBND	100	OU3075NAMA	179	OU3405SLJA	140	OU6023GBFA	193	OU7024GBCB	190
OF4250BBFA	94	OU3077NBFA	179	OU3405SLVA	140	OU6024GBCA	195	OU7025GBCB	190
OF4250BBNA	94	OU3095SBCA	181	OU3501GBCA	192	OU6025FBCB	156	OU7025GBNB	190
OF4250NBFA	94	OU3096SBCA	181	OU3580NBCD	175	OU6026C00K	149	OU7027NBFA	188
OF4250NBNA	94	OU3141FBFA	184	OU3581NBCB	175	OU6031GBCA	193	OU7046SBCG	186
OF8021BBNA	98	OU3141GBFA	184	OU3591NBFA	175	OU6039GBCD	158	OU7046SRGG	186
OF8021NBNA	98	OU3150NBCB	176	OU3591NBFA	175	OU6046GBCB	170	OU7048SBCG	186
OF8022BBNA	98	OU3150NBFB	176	OU3592NBFA	175	OU6049NBCB	156	OU7064FBFA	190
OF8022BBND	98	OU3152NBCB	176	OU3592NBFA	175	OU6053BBCB	158	OU7065FBFA	190
OF8022GBNA	98	OU3152NBFB	176	OU3593NBFA	175	OU6055BBCB	158	OU7071NRGA	146
OF8022NBNA	98	OU3154NBCB	176	OU3593NBFA	175	OU6066NBNA	211	OU7072NRGA	146
OF8034BBNA	96	OU3160NBFA	177	OU3594NBFA	175	OU6068NBNA	211	OU7074NBFA	216
OF8034GBNA	96	OU3161NBFA	177	OU3594NBFA	175	OU6074NBFA	157	OU7103NBFA	216
OF8056BBNA	98	OU3162NBFA	177	OU3595SBCA	174	OU6075NBFA	157	OU7110GBCB	189
OF8056GBNA	98	OU3163NBFA	177	OU3595SBFA	174	OU6080GBNB	157	OU7111GBCB	189
OF8056NBNA	98	OU3164NBFA	177	OU3596SBCA	174	OU6082FBNA	153	OU7112GBCB	189
OF8192BBNA	98	OU3165NBFA	177	OU3596SBFA	174	OU6083FBNA	153	OU7113GBCB	189
OU2006BBCB	166	OU3166NBFA	177	OU3596SRGA	144	OU6084NBFA	152	OU7161FBFA	200
OU2006GBCB	166	OU3168NBFA	176	OU3597SBCA	174	OU6085FBNA	153	OU7161GBFA	200
OU2007GBCB	166	OU3168NBFA	176	OU3597SBFA	174	OU6086CBFA	153	OU7360NRGA	146
OU2008GBCB	166	OU3170NBFA	176	OU3597SMLA	144	OU6087CBFA	153	OU7400GLAA	142
OU2009GBCB	166	OU3170NBFA	176	OU3597SRGA	144	OU6091FBCB	156	OU7400GLCA	142
OU2012NBFA	162	OU3172NBFA	176	OU3599GBCA	192	OU6092FBCB	156	OU7400GLEA	142
OU2013BBCB	162	OU3174NBFA	176	OU3599GBFA	192	OU6095FBNB	157	OU7400GLJA	142
OU2013NBCB	162	OU3174NBFA	176	OU3599GRGA	145	OU6599GBCA	194	OU7400GLVA	142
OU2014BBCB	162	OU3176NAMA	176	OU3599GRGA	192	OU6599GBFA	194	OU7400GMGA	142
OU2014NBCB	162	OU3176NBFA	176	OU3601GBCA	192	OU6599GRGA	194	OU7401GLAA	142
OU2015NBFA	163	OU3176NBFA	176	OU3601GBFA	192	OU6601GBCA	194	OU7401GLCA	142
OU2016NBFA	163	OU3178NAMA	176	OU3601GRGA	145	OU6601GBFA	194	OU7401GLEA	142
OU2017NBFA	163	OU3178NBFA	176	OU3601GRGA	192	OU6601GRGA	145	OU7401GLJA	142
OU2018NBFA	165	OU3178NBFA	176	OU3603GBCA	193	OU6602GRGA	145	OU7401GLVA	142
OU2019NBFA	162	OU3400GLAA	141	OU3603GBFA	193	OU6603GBCA	194	OU7401GMGA	142
OU2100NBCB	163	OU3400GLCA	141	OU3605GBCA	193	OU6603GBFA	194	OU7402GLAA	142
OU2101NBCB	163	OU3400GLEA	141	OU3605GBFA	193	OU6605GBCA	194	OU7402GLJA	142
OU3022C00K	149	OU3400GLJA	141	OU3606SBCA	192	OU6605GBFA	194	OU7402GLVA	142
OU3023C00K	149	OU3400GLVA	141	OU3606SBFA	192	OU6606SBCA	194	OU7403GLAA	142
OU3026AB	180	OU3400GMGA	141	OU3607SBCA	193	OU6607SBCA	194	OU7403GLJA	142
OU3026BCB	180	OU3401GLAA	141	OU3607SBFA	193	OU6608GBCA	195	OU7403GLVA	142
OU3027GBCF	180	OU3401GLCA	141	OU3608SBCA	174	OU6609GBCA	195	OU9004FBCB	171
OU3028GBCF	180	OU3401GLEA	141	OU3700GBFA	193	OU6610GBCA	160	OU9004FBFB	171
OU3029GBCF	180	OU3401GLJA	141	OU3700GBNA	193	OU6611BBCA	160	OU9010C00K	148
OU3032SBCB	174	OU3401GLVA	141	OU3701GBCA	193	OU6612NRGG	160	OU9011CBCF	148
OU3034BCB	174	OU3401GMGA	141	OU3701GBFA	193	OU6800NBFA	152	OU9012C00K	148
OU3042FBFA	184	OU3402GLAA	141	OU3701GBNA	193	OU6801SBFA	152	OU9021FBNA	204

CÓDIGO	PÁG
OU9023SBNB	204
OU9035FBFA	205
OU9036FBFA	205
OU9041FBFA	203
OU9042FBFA	203
OU9045FBNB	168
OU9047GBNB	170
OU9050GBNB	170
OU9051GBNA	168
OU9080FBNA	202
OU9085GBNB	171
OU9086FBFA	202
OU9087FBFA	202
OU9089SBCB	170
OU9090FBNB	171
OU9091FBNB	171
OU9092CBCA	170
OU9093CBCA	170
OU9095FBCB	171
OU9095FBNB	171
OU9100FBNA	204
OU9200FBFA	204
OU9201FBFA	202
OU9905GNCA	168
OU9906NBCA	205
OU9907NBCA	205
OU9908FBFA	203
OU9909FBFA	203
RE0001DBCB	92
RE0001NBCB	92
RE1035BBCD	23
RE1035BBND	23
RE1036BBCD	23
RE1036BBND	23
RE1041BBFA	22
RE1041BBCD	22
RE1041BBFA	22
RE1041BBNA	22
RE1044BBCD	23
RE1044BBND	23
RE1046BBND	23
RE1047BBCB	20
RE1048BBFA	29
RE1049BBCB	20
RE1054BBCB	28
RE1054BBFB	28
RE1054BBNB	28
RE1055BBCB	28
RE1055BBFB	28
RE1055BBNB	28
RE1058BBCB	28
RE1058BBFB	28

CÓDIGO	PÁG
RE1070BBCB	39
RE1071BBFA	41
RE1072BBFA	41
RE1073BBCB	39
RE1074BBCB	39
RE1076BBFA	41
RE1077BBFA	37
RE1077BBCB	39
RE1077NBCA	37
RE1078BBFA	37
RE1078BBCB	39
RE1078NBCA	37
RE1079BBFA	37
RE1079NBCA	37
RE1080BBCD	42
RE1080BBFD	42
RE1081BBCD	42
RE1081BBFB	42
RE1081BBFD	42
RE1082BBCD	42
RE1083BBCD	42
RE1084BBCD	42
RE1085BBCD	42
RE1085BBFB	42
RE1085BBFD	42
RE1087BBCB	40
RE1087NBCB	40
RE1090BBCB	26
RE1090BBNB	26
RE1091BBNB	26
RE1091BBNB	26
RE1092BBCB	26
RE1092BBNB	26
RE1093BBCB	26
RE1093BBNB	26
RE1095BBCB	26
RE1095BBNB	26
RE1096BBCB	26
RE1096BBNB	26
RE1097BBCB	26
RE1097BBNB	26
RE1098BBCB	26
RE1098BBNB	26
RE1101BBCB	25
RE1101BBNB	25
RE1102BBCB	25
RE1102BBNB	25
RE1103BBCB	25
RE1103BBCB	25
RE1106BBCB	24
RE1106BBNB	24
RE1107BBCB	24

CÓDIGO	PÁG
RE1107BBNB	24
RE1108BBCB	24
RE1108BBNB	24
RE1111BBFA	27
RE1111BBFA	27
RE1111BBNA	27
RE1112BBFA	27
RE1112BBFA	27
RE1112BBNA	27
RE1113BBFA	27
RE1113BBFA	27
RE1113BBNA	27
RE1116BBFA	27
RE1116BBNA	27
RE1117BBFA	27
RE1117BBFA	27
RE1117BBNA	27
RE1118BBFA	27
RE1118BBFA	27
RE1118BBNA	27
RE1212BBCD	23
RE1247BBND	23
RE1300BBCB	40
RE1300NBCB	40
RE1302BBCB	38
RE1302NBCB	38
RE1304BBCB	38
RE1304NBCB	38
RE1306BBCB	38
RE1306NBCB	38
RE1309BBCB	38
RE1309NBCB	38
RE1310BBCB	40
RE1311BBCB	40
RE1312BBCB	40
RE1313BBCB	40
RE2003GBCD	166
RE2006SBCB	180
RE2010GBCD	166
RE4023BBCD	88
RE4023BBND	88
RE4024BBCD	88
RE4024BBND	88
RE4030BBCB	88
RE4030NBCB	88
RE4031BBCB	88
RE4031NBCB	88
RE4032BBCB	88
RE4033BBCB	52
RE4033NBCB	52

CÓDIGO	PÁG
RE4034BBCB	52
RE4034NBCB	52
RE4035BBCB	52
RE4035NBCB	52
RE4036BBCB	52
RE4036NBCB	52
RE4060GBCB	87
RE4065GBCB	87
RE6008GBCD	165
RE6036AMG	112
RE6036BCG	112
RE6036BFG	112
RE6036BNG	112
RE6037BCG	112
RE6037BFG	112
RE6037BNG	112
RE6038BCG	112
RE6038BFG	112
RE6038BNG	112
RE6039AMG	112
RE6039BCG	112
RE6039BFG	112
RE6057BBCB	90
RE6058BBCB	90
RE6058NBCB	90
RE6059BBCB	90
RE6059NBCB	90
RE6070BBCB	91
RE6071BBCB	91
RE6072BBCB	91
RE6073BBCB	89
RE6074BBCB	89
RE6077DBCB	89
RE6077NBCB	89
RE6090SBCB	91
RE6093SBCB	91
RE8020BBCB	77
RE8021BBCB	77
RE8023BBCB	77
RE8024BBCB	78
RE8025BBCB	78
RE8041BBCB	79
RE8043BBCB	80
RE8044BBCB	80
RE8049DBCB	72
RE8049NBCB	72
RE8051BBCB	81
RE8052NBCB	72
RE8053BBCB	78
RE8054BBCB	78
RE8055DBCB	73
RE8055NBCB	73

CÓDIGO	PÁG
RE8056NBCB	75
RE8057BBCB	76
RE8058BBCB	80
RE8059NBCB	76
RE8060NBCB	82
RE8061NBCB	82
RE8070BBCB	85
RE8071BBCB	85
RE8072BBCB	85
RE8075BBCB	79
RE8076BBCB	86
RE8077BBCB	86
RE8079BBNB	79
RE8080BBCB	86
RE8090SBCB	84
RE8096SBCB	84
RE8099NBCB	75
RE8116NBCB	83
RE8117NBCB	83
RE8118NBCB	83
RE8123NBCB	76
RE8130NBCB	74
RE8131BBCB	74
RE8140NBCB	75
V0040UN2M50	208
V0052UN2M50	208
V0052UN3M50	208
V1050UN2M40	209
V1050UN2M50	209
V1050UN2M50STG	209
V1050UN3M40	209
V1050UN3M50	209
V2070UN2M40	209
V2070UN2M50	209
V2070UN2M50	210
V2070UN3M40	209
V2070UN3M50	209
V2085UN2M50	210
V2100UN2M40	209
V2100UN2M50	209
V2100UN3M40	209
V2100UN3M50	209
V2130UN2M40	209
V2130UN2M50	209
V3160UN2M40	210
V3160UN2M50	210
V3160UN3M40	210
V3200UN3M50	210
V4305UN3M50	211

INTERIOR

ESPACIOS QUE ATRAEN

Lleva tus proyectos al siguiente nivel con la amplia gama de luminarias y accesorios de iluminación para satisfacer las necesidades más exigentes del diseño de espacios.

CONSTRULITA[®]
EL SENTIDO DE LA LUZ





LUMINARIOS DE TECHO



RE1047BBCB

LED	25 WATTS	2240 LUMENS	3000K	90° ANGLULO APERTURA	IP20	BLANCO
-----	----------	-------------	-------	----------------------	------	--------

NUEVO

*Sistema óptico diseñado especialmente para ofrecer un alto confort visual, al evitar deslumbramiento

RE1047BBNB

LED	25 WATTS	2240 LUMENS	4000K	90° ANGLULO APERTURA	IP20	BLANCO
-----	----------	-------------	-------	----------------------	------	--------



ANTI-GLARE

RE1049BBCB

LED	25 WATTS	2278 LUMENS	3000K	90° ANGLULO APERTURA	IP20	BLANCO
-----	----------	-------------	-------	----------------------	------	--------

NUEVO

*Sistema óptico diseñado especialmente para ofrecer un alto confort visual, al evitar deslumbramiento

RE1049BBNB

LED	25 WATTS	2278 LUMENS	4000K	90° ANGLULO APERTURA	IP20	BLANCO
-----	----------	-------------	-------	----------------------	------	--------



ANTI-GLARE



DIMMABLE 0-10 V

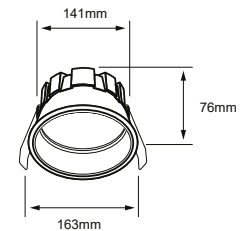
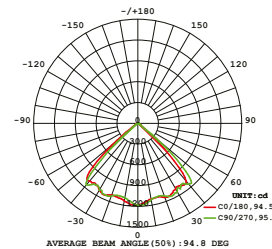
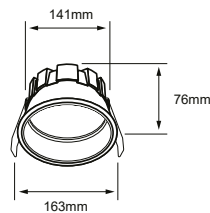
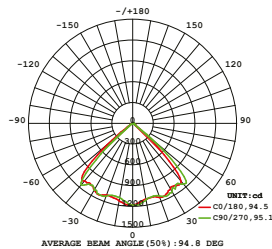

CODIGO	MATERIAL DE CUERPO	COLOR	POTENCIA	FLUJO LUMINOSO	ALIMENTACIÓN	TCC	VIDA ÚTIL (L80)	DRIVER	FUENTE DE LUZ	ÁNGULO DE APERTURA (VxH)	IRC	FP	IP	CORTE DE EMPOTRAMIENTO	IK	PESO (KG)
RE1047BBCB	Aluminio/Plastico	<input type="checkbox"/>	25 W	2240 lm	100-240 V ~	3 000 K	30000 h	Driver LED	LED Integrado	90°	90	0.9	20	150 mm	5	0.75
RE1047BBNB	Aluminio/Plastico	<input type="checkbox"/>	25 W	2240 lm	100-240 V ~	4 000 K	30000 h	Driver LED	LED Integrado	90°	90	0.9	20	150 mm	5	0.75
RE1049BBCB	Aluminio/Plastico	<input type="checkbox"/>	25 W	2278 lm	100-240 V ~	3 000 K	30000 h	Driver LED	LED Integrado	90°	90	0.9	20	150 mm	5	0.75
RE1049BBNB	Aluminio/Plastico	<input type="checkbox"/>	25 W	2278 lm	100-240 V ~	4 000 K	30000 h	Driver LED	LED Integrado	90°	90	0.9	20	150 mm	5	0.75

CO1200BBCA

LED 45 WATTS 4464 LUMENS 3000K 60° ANGLULO APERTURA IP30 BLANCO

CO1200BBNA

LED 45 WATTS 4575 LUMENS 4000K 60° ANGLULO APERTURA IP30 BLANCO

CO1200BBFA

LED 45 WATTS 4575 LUMENS 6500K 60° ANGLULO APERTURA IP30 BLANCO

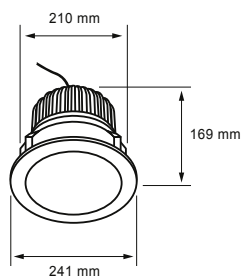
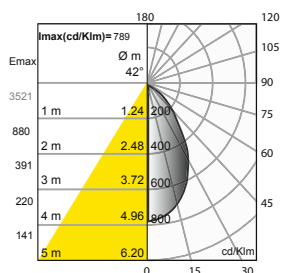

CO1214BBCA

LED 74 WATTS 6629 LUMENS 3000K 60° ANGLULO APERTURA IP30 BLANCO

CO1214BBFA

LED 74 WATTS 6629 LUMENS 5000K 60° ANGLULO APERTURA IP30 BLANCO

CO1214BBNA

LED 74 WATTS 6629 LUMENS 4000K 60° ANGLULO APERTURA IP30 BLANCO

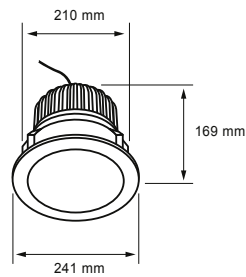
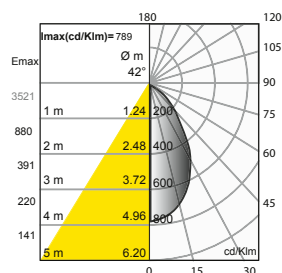

CO1300BBCA

LED 100 WATTS 11070 LUMENS 3000K 60° ANGLULO APERTURA IP30 BLANCO

CO1300BBFA

LED 100 WATTS 11070 LUMENS 5000K 60° ANGLULO APERTURA IP30 BLANCO

CO1300BBNA

LED 100 WATTS 11070 LUMENS 4000K 60° ANGLULO APERTURA IP30 BLANCO

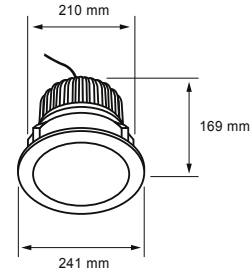
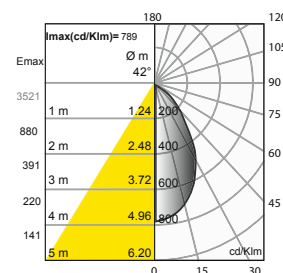

CÓDIGO	MATERIAL DE CUERPO	COLOR	POTENCIA	FLUJO LUMINOSO	ALIMENTACIÓN	TCC	VIDA ÚTIL (L80)	DRIVER	FUENTE DE LUZ	ÁNGULO DE APERTURA (VxH)	IRC	FP	IP	CORTE DE EMPOTRAMIENTO	PESO (KG)
CO1200BBCA	Aluminio	☐	45 W	4464 lm	127-277 V	3 000 K	50 000 h	Driver electrónico	LED Integrado	60°	80	0.95	30	210 mm	2.8
CO1200BBNA	Aluminio	☐	45 W	4575 lm	127-277 V	4 000 K	50 000 h	Driver electrónico	LED Integrado	60°	80	0.95	30	210 mm	2.8
CO1200BBFA	Aluminio	☐	45 W	4575 lm	127-277 V	6 500 K	50 000 h	Driver electrónico	LED Integrado	60°	80	0.95	30	210 mm	2.8
CO1214BBCA	Aluminio	☐	74 W	6629 lm	127-277 V	3 000 K	50 000 h	Driver electrónico	LED Integrado	60°	80	0.95	30	210 mm	3.56
CO1214BBFA	Aluminio	☐	74 W	6629 lm	127-277 V	5 000 K	50 000 h	Driver electrónico	LED Integrado	60°	80	0.95	30	210 mm	3.56
CO1214BBNA	Aluminio	☐	74 W	6629 lm	127-277 V	4 000 K	50 000 h	Driver electrónico	LED Integrado	60°	80	0.95	30	210 mm	3.56
CO1300BBCA	Aluminio	☐	100 W	11070 lm	127-277 V	3 000 K	50 000 h	Driver electrónico	LED Integrado	60°	80	0.9	30	210 mm	3.5
CO1300BBFA	Aluminio	☐	100 W	11070 lm	127-277 V	5 000 K	50 000 h	Driver electrónico	LED Integrado	60°	80	0.9	30	210 mm	3.5
CO1300BBNA	Aluminio	☐	100 W	11070 lm	127-277 V	4 000 K	50 000 h	Driver electrónico	LED Integrado	60°	80	0.9	30	210 mm	3.5

RE1041BBCA

LED 40 WATTS 4340 LUMENS 3000K 120° ANGULO APERTURA IP30 BLANCO

RE1041BBCD

LED 18 WATTS 1360 LUMENS 3000K 120° ANGULO APERTURA IP30 BLANCO **N**

RE1041BBFA

LED 40 WATTS 4340 LUMENS 5000K 120° ANGULO APERTURA IP30 BLANCO

RE1041BBNA

LED 40 WATTS 4340 LUMENS 4000K 120° ANGULO APERTURA IP30 BLANCO **N**

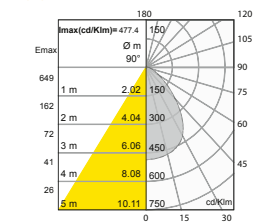

CO1024BBCA

LED 24 WATTS 1750 LUMENS 3000K 120° ANGULO APERTURA IP30 BLANCO

CO1024BBNA

LED 24 WATTS 1830 LUMENS 4000K 120° ANGULO APERTURA IP30 BLANCO

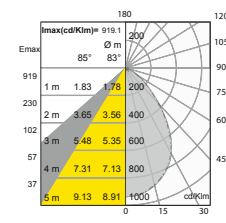

CO1040BBNA

LED 40 WATTS 2650 LUMENS 4000K 120° ANGULO APERTURA IP30 BLANCO

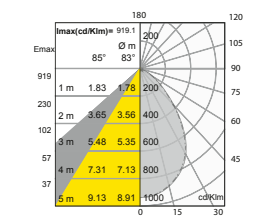

CO1216BBCA

LED 24 WATTS 1800 LUMENS 3000K 60° ANGULO APERTURA IP30 BLANCO

CO1216BBNA

LED 24 WATTS 1800 LUMENS 4000K 55° ANGULO APERTURA IP30 BLANCO

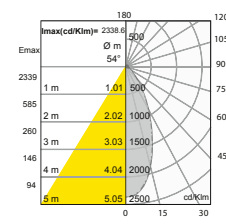

CÓDIGO	MATERIAL DE CUERPO	COLOR	POTENCIA	FLUJO LUMINOSO	ALIMENTACIÓN	TCC	VIDA ÚTIL (L80)	DRIVER	FUENTE DE LUZ	ÁNGULO DE APERTURA (VxH)	IRC	FP	IP	CORTE DE EMPOTRAMIENTO	PESO (KG)
RE1041BBCA	Aluminio	<input type="checkbox"/>	40 W	4340 lm	127-277 V	3 000 K	50 000 h	Driver electrónico	LED Integrado	120°	90	0.9	30	155 mm	0.73
RE1041BBCD	Aluminio	<input type="checkbox"/>	18 W	1360 lm	127 V	3 000 K	50 000 h	Driver electrónico	LED Integrado	120°	90	0.95	30	155 mm	0.73
RE1041BBFA	Aluminio	<input type="checkbox"/>	40 W	4340 lm	127-277 V	5 000 K	50 000 h	Driver electrónico	LED Integrado	120°	90	0.9	30	155 mm	0.73
RE1041BBNA	Aluminio	<input type="checkbox"/>	40 W	4340 lm	127-277 V	4 000 K	50 000 h	Driver electrónico	LED Integrado	120°	90	0.9	30	155 mm	0.73
CO1024BBCA	Aluminio	<input type="checkbox"/>	24 W	1750 lm	127-277 V	3 000 K	50 000 h	Driver electrónico	LED Integrado	120°	95	0.95	30	210 mm	0.904
CO1024BBNA	Aluminio	<input type="checkbox"/>	24 W	1830 lm	127-277 V	4 000 K	50 000 h	Driver electrónico	LED Integrado	120°	90	0.9	30	210 mm	1.68
CO1040BBNA	Aluminio	<input type="checkbox"/>	40 W	2650 lm	127-277 V	4 000 K	50 000 h	Driver electrónico	LED Integrado	120°	90	0.9	30	210 mm	1.68
CO1216BBCA	Aluminio	<input type="checkbox"/>	24 W	1800 lm	127-277 V	3 000 K	50 000 h	Driver electrónico	LED Integrado	60°	90	0.9	30	210 mm	1.676
CO1216BBNA	Aluminio	<input type="checkbox"/>	24 W	1800 lm	127-277 V	4 000 K	50 000 h	Driver electrónico	LED Integrado	55°	90	0.9	30	210 mm	1.676

RE1035BBCD

LED 4.5 WATTS 350 LUMENS 3000K 100° ANGLULO APERTURA IP30 BLANCO

RE1035BBND

LED 4.5 WATTS 350 LUMENS 4000K 100° ANGLULO APERTURA IP30 BLANCO

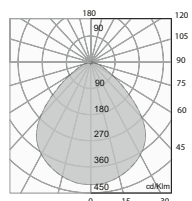

ø145 mm

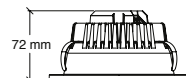
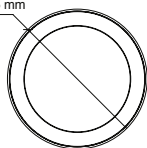

RE1044BBCD

LED 9 WATTS 700 LUMENS 3000K WW ANGLULO APERTURA IP30 BLANCO

RE1044BBND

LED 9 WATTS 700 LUMENS 4000K WW ANGLULO APERTURA IP30 BLANCO

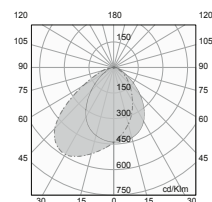

ø145 mm

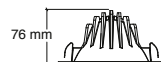
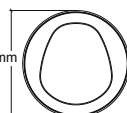

RE1046BBND

LED 9 WATTS 700 LUMENS 4000K WW ANGLULO APERTURA IP30 BLANCO

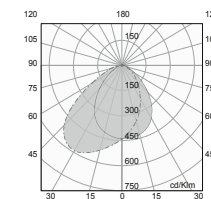

145 mm

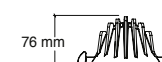
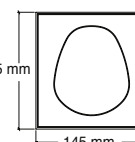

RE1036BBCD

LED 9 WATTS 700 LUMENS 3000K 100° ANGLULO APERTURA IP30 BLANCO

RE1036BBND

LED 9 WATTS 700 LUMENS 4000K 100° ANGLULO APERTURA IP30 BLANCO

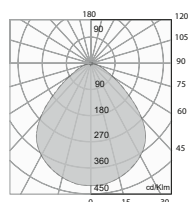

ø145 mm

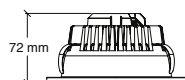
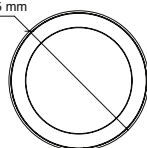

RE1212BBCD

LED 4.5 WATTS 350 LUMENS 3000K 120° ANGLULO APERTURA IP30 BLANCO

RE1212BBND

LED 4.5 WATTS 350 LUMENS 4000K 120° ANGLULO APERTURA IP30 BLANCO

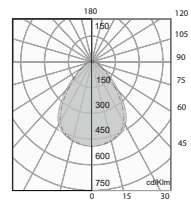

ø110 mm

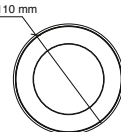

RE1247BBND

LED 4.5 WATTS 350 LUMENS 4000K 120° ANGLULO APERTURA IP30 BLANCO

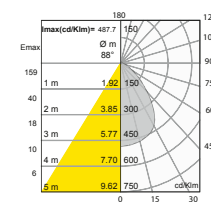

110 mm

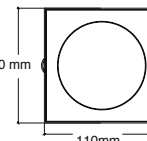

CÓDIGO	MATERIAL DE CUERPO	COLOR	POTENCIA	FLUJO LUMINOSO	ALIMENTACIÓN	TCC	VIDA ÚTIL(L80)	DRIVER	FUENTE DE LUZ	ÁNGULO DE APERTURA (VxH)	IRC	FP	IP	CORTE DE EMPOTRAMIENTO	PESO (KG)
RE1035BBCD	Aluminio	□	4.5 W	350 lm	127 V	3 000 K	50 000 h	Circuito Integrado	LED Integrado	100°	90	0.95	30	120 mm	0.534
RE1035BBND	Aluminio	□	4.5 W	350 lm	127 V	4 000 K	50 000 h	Circuito Integrado	LED Integrado	100°	80	0.95	30	120 mm	0.534
RE1044BBCD	Aluminio	□	9 W	700 lm	127 V	3 000 K	50 000 h	Circuito Integrado	LED Integrado	90°	90	0.95	30	120 mm	0.568
RE1044BBND	Aluminio	□	9 W	700 lm	127 V	4 000 K	50 000 h	Circuito Integrado	LED Integrado	90°	80	0.95	30	120 mm	0.568
RE1046BBND	Aluminio	□	9 W	700 lm	127 V	4 000 K	50 000 h	Circuito Integrado	LED Integrado	90°	80	0.95	30	120 mm	0.568
RE1036BBCD	Aluminio	□	9 W	700 lm	127 V	3 000 K	50 000 h	Circuito Integrado	LED Integrado	100°	90	0.95	30	120 mm	0.568
RE1036BBND	Aluminio	□	9 W	700 lm	127 V	4 000 K	50 000 h	Circuito Integrado	LED Integrado	100°	80	0.95	30	120 mm	0.568
RE1212BBCD	Aluminio	□	4.5 W	350 lm	127 V	3 000 K	50 000 h	Circuito Integrado	LED Integrado	120°	90	0.95	30	85 mm	0.34
RE1212BBND	Aluminio	□	4.5 W	350 lm	127 V	4 000 K	50 000 h	Circuito Integrado	LED Integrado	120°	80	0.95	30	85 mm	0.34
RE1247BBND	Aluminio	□	4.5 W	350 lm	127 V	4 000 K	50 000 h	Circuito Integrado	LED Integrado	120°	80	0.95	30	85 mm	0.34

RE1106BBCB

LED 10 WATTS 660 LUMENS 3000K 120° ANGLULO APERTURA IP30 BLANCO

RE1106BBNB

LED 10 WATTS 660 LUMENS 4000K 120° ANGLULO APERTURA IP30 BLANCO



DIMMEABLE 0-10 V

RE1107BBCB

LED 13 WATTS 1170 LUMENS 3000K 120° ANGLULO APERTURA IP30 BLANCO

RE1107BBNB

LED 13 WATTS 1205 LUMENS 4000K 120° ANGLULO APERTURA IP30 BLANCO



DIMMEABLE 0-10 V

RE1108BBCB

LED 21 WATTS 1835 LUMENS 3000K 120° ANGLULO APERTURA IP30 BLANCO

RE1108BBNB

LED 21 WATTS 2005 LUMENS 4000K 120° ANGLULO APERTURA IP30 BLANCO



DIMMEABLE 0-10 V

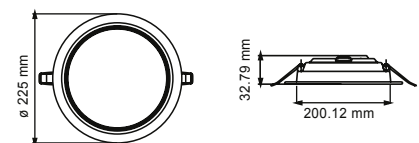
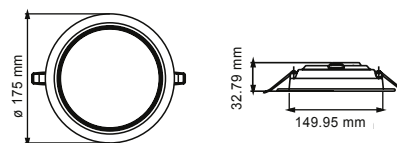
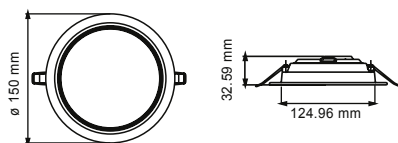
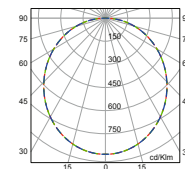
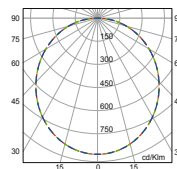
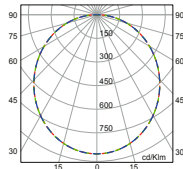

ACCESORIO PARA RE1106BBCB, RE1106BBNB
AC4096B

Accesorio para **sobreponer** MARCO/BASE pag. 219

ACCESORIO PARA RE1107BBCB, RE1107BBNB
AC4097B

Accesorio para **sobreponer** MARCO/BASE pag. 219

ACCESORIO PARA RE1108BBCB, RE1108BBNB
AC4098B

Accesorio para **sobreponer** MARCO/BASE pag. 219

CÓDIGO	MATERIAL DE CUERPO	COLOR	POTENCIA	FLUJO LUMINOSO	ALIMENTACIÓN	TCC	VIDA ÚTIL (L80)	DRIVER	FUENTE DE LUZ	ÁNGULO DE APERTURA (VxH)	IRC	FP	IP	CORTE DE EMPOTRAMIENTO	PESO (KG)
RE1106BBCB	Aluminio	<input type="checkbox"/>	10 W	660 lm	127-220 V	<input type="checkbox"/> 3 000 K	30 000 h	Driver electrónico	LED Integrado	120°	80	0.85	30	125 mm	0.34
RE1106BBNB	Aluminio	<input type="checkbox"/>	10 W	660 lm	127-220 V	<input type="checkbox"/> 4 000 K	30 000 h	Driver electrónico	LED Integrado	120°	80	0.85	30	125 mm	0.25
RE1107BBCB	Aluminio	<input type="checkbox"/>	13 W	1170 lm	127-220 V	<input type="checkbox"/> 3 000 K	30 000 h	Driver electrónico	LED Integrado	120°	80	0.83	30	150 mm	0.46
RE1107BBNB	Aluminio	<input type="checkbox"/>	13 W	1205 lm	127-220 V	<input type="checkbox"/> 4 000 K	30 000 h	Driver electrónico	LED Integrado	120°	80	0.83	30	150 mm	0.35
RE1108BBCB	Aluminio	<input type="checkbox"/>	21 W	1835 lm	127-220 V	<input type="checkbox"/> 3 000 K	30 000 h	Driver electrónico	LED Integrado	120°	80	0.83	30	200 mm	0.65
RE1108BBNB	Aluminio	<input type="checkbox"/>	21 W	2005 lm	127-220 V	<input type="checkbox"/> 4 000 K	30 000 h	Driver electrónico	LED Integrado	120°	80	0.83	30	200 mm	0.6

RE1101BBCB

LED 10 WATTS 655 LUMENS 3000K 120° ANGLULO APERTURA IP30 BLANCO

RE1101BBNB

LED 10 WATTS 660 LUMENS 4000K 120° ANGLULO APERTURA IP30 BLANCO



RE1102BBCB

LED 13 WATTS 1175 LUMENS 3000K 120° ANGLULO APERTURA IP30 BLANCO

RE1102BBNB

LED 13 WATTS 1250 LUMENS 4000K 120° ANGLULO APERTURA IP30 BLANCO



RE1103BBCB

LED 13 WATTS 1175 LUMENS 3000K 120° ANGLULO APERTURA IP30 BLANCO

RE1103BBNB

LED 13 WATTS 1175 LUMENS 4000K 120° ANGLULO APERTURA IP30 BLANCO

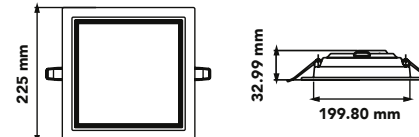
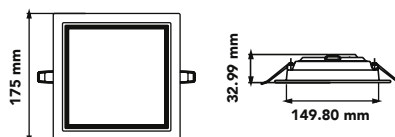
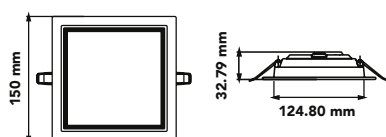
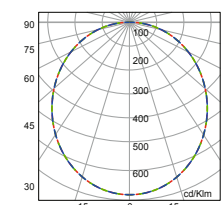
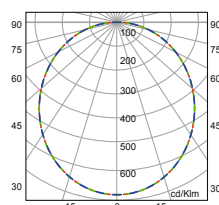
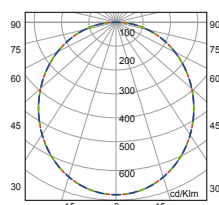

ACCESORIO

AC4091B

Accesorio para **sobreponer** MARCO/BASE pag. 219

ACCESORIO

AC4092B

Accesorio para **sobreponer** MARCO/BASE pag. 219

ACCESORIO

AC4093B

Accesorio para **sobreponer** MARCO/BASE pag. 219

CÓDIGO	MATERIAL DE CUERPO	COLOR	POTENCIA	FLUJO LUMINOSO	ALIMENTACIÓN	TCC	VIDA ÚTIL (L80)	DRIVER	FUENTE DE LUZ	ÁNGULO DE APERTURA (VxH)	IRC	FP	IP	CORTE DE EMPOTRAMIENTO	PESO (KG)
RE1101BBCB	Aluminio	<input type="checkbox"/>	10 W	655 lm	127-220 V	3 000 K	30 000 h	Driver electrónico	LED Integrado	120°	80	0.85	30	125X125 mm	0.25
RE1101BBNB	Aluminio	<input type="checkbox"/>	10 W	660 lm	127-220 V	4 000 K	30 000 h	Driver electrónico	LED Integrado	120°	80	0.85	30	125X125 mm	0.25
RE1102BBCB	Aluminio	<input type="checkbox"/>	13 W	1175 lm	127-220 V	3 000 K	30 000 h	Driver electrónico	LED Integrado	120°	80	0.8	30	150X150 mm	0.42
RE1102BBNB	Aluminio	<input type="checkbox"/>	13 W	1250 lm	127-220 V	4 000 K	30 000 h	Driver electrónico	LED Integrado	120°	80	0.8	30	150X150 mm	0.35
RE1103BBCB	Aluminio	<input type="checkbox"/>	21 W	1700 lm	127-220 V	3 000 K	30 000 h	Driver electrónico	LED Integrado	120°	80	0.9	30	200X200 mm	0.7
RE1103BBNB	Aluminio	<input type="checkbox"/>	21 W	1700 lm	127-220 V	4 000 K	30 000 h	Driver electrónico	LED Integrado	120°	80	0.9	30	200X200 mm	0.7

RE1095BBCB

LED	7 WATTS	655 LUMENS	3000K	120° ANGULO APERTURA	IP30	BLANCO
-----	---------	------------	-------	----------------------	------	--------

RE1095BBNB

LED	7 WATTS	675 LUMENS	4000K	120° ANGULO APERTURA	IP30	BLANCO
-----	---------	------------	-------	----------------------	------	--------



RE1096BBCB

LED	12 WATTS	1069 LUMENS	3000K	120° ANGULO APERTURA	IP30	BLANCO
-----	----------	-------------	-------	----------------------	------	--------

RE1096BBNB

LED	12 WATTS	1100 LUMENS	4000K	120° ANGULO APERTURA	IP30	BLANCO
-----	----------	-------------	-------	----------------------	------	--------

ACCESORIO

AC4096B

Litepad Acc Sobrep Techo 155x155mm
Blanco / Plástico Inyectado



RE1097BBCB

LED	18 WATTS	1715 LUMENS	3000K	120° ANGULO APERTURA	IP30	BLANCO
-----	----------	-------------	-------	----------------------	------	--------

RE1097BBNB

LED	18 WATTS	1750 LUMENS	4000K	120° ANGULO APERTURA	IP30	BLANCO
-----	----------	-------------	-------	----------------------	------	--------

ACCESORIO

AC4097B

Litepad Acc Sobrep Techo 180x180mm
Blanco / Plástico Inyectado



RE1098BBCB

LED	25 WATTS	2430 LUMENS	3000K	120° ANGULO APERTURA	IP30	BLANCO
-----	----------	-------------	-------	----------------------	------	--------

RE1098BBNB

LED	25 WATTS	2500 LUMENS	4000K	120° ANGULO APERTURA	IP30	BLANCO
-----	----------	-------------	-------	----------------------	------	--------

ACCESORIO

AC4098B

Litepad Acc Sobrep Techo 230x230mm
Blanco / Plástico Inyectado



RE1090BBCB

LED	7 WATTS	640 LUMENS	3000K	120° ANGULO APERTURA	IP30	BLANCO
-----	---------	------------	-------	----------------------	------	--------

RE1090BBNB

LED	7 WATTS	650 LUMENS	4000K	120° ANGULO APERTURA	IP30	BLANCO
-----	---------	------------	-------	----------------------	------	--------

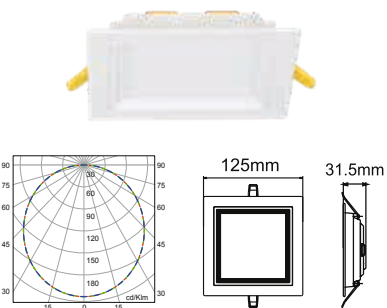

RE1091BBCB

LED	12 WATTS	1090 LUMENS	3000K	120° ANGULO APERTURA	IP30	BLANCO
-----	----------	-------------	-------	----------------------	------	--------

RE1091BBNB

LED	12 WATTS	1150 LUMENS	4000K	120° ANGULO APERTURA	IP30	BLANCO
-----	----------	-------------	-------	----------------------	------	--------

ACCESORIO

AC4091B

Litepad Acc Sobrep Techo 157x157mm
Blanco / Plástico Inyectado

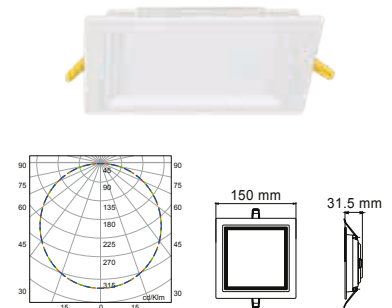

RE1092BBCB

LED	18 WATTS	1715 LUMENS	3000K	120° ANGULO APERTURA	IP30	BLANCO
-----	----------	-------------	-------	----------------------	------	--------

RE1092BBNB

LED	18 WATTS	1750 LUMENS	4000K	120° ANGULO APERTURA	IP30	BLANCO
-----	----------	-------------	-------	----------------------	------	--------

ACCESORIO

AC4092B

Litepad Acc Sobrep Techo 180x180mm
Blanco / Plástico Inyectado

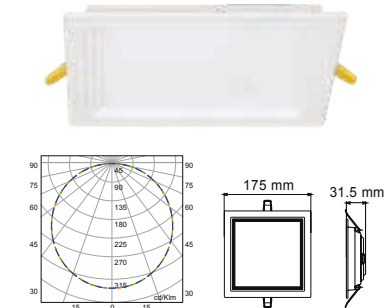

RE1093BBCB

LED	25 WATTS	2430 LUMENS	3000K	120° ANGULO APERTURA	IP30	BLANCO
-----	----------	-------------	-------	----------------------	------	--------

RE1093BBNB

LED	25 WATTS	2500 LUMENS	4000K	120° ANGULO APERTURA	IP30	BLANCO
-----	----------	-------------	-------	----------------------	------	--------

ACCESORIO

AC4093B

Litepad Acc Sobrep Techo 230x230mm
Blanco / Plástico Inyectado

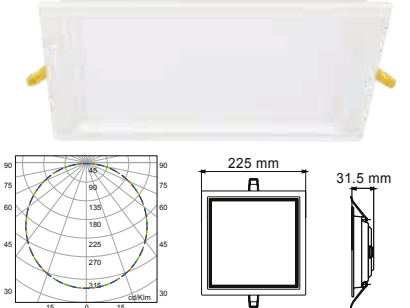

CÓDIGO	MATERIAL DE CUERPO	COLOR	POTENCIA	FLUJO LUMINOSO	ALIMENTACIÓN	TCC	VIDA ÚTIL (L80)	DRIVER	FUENTE DE LUZ	ÁNGULO DE APERTURA (VxH)	IRC	FP	IP	CORTE DE EMPOTRAMIENTO	PESO (KG)
RE1095BBCB	Aluminio	□	7 W	655 lm	127-220 V	3 000 K	25 000 h	Driver electrónico	LED Integrado	120°	80	0.9	30	100 mm	0.14
RE1095BBNB	Aluminio	□	7 W	675 lm	127-220 V	4 000 K	25 000 h	Driver electrónico	LED Integrado	120°	80	0.9	30	100 mm	0.14
RE1096BBCB	Aluminio	□	12 W	1069 lm	127-220 V	3 000 K	25 000 h	Driver electrónico	LED Integrado	120°	80	0.95	30	125 mm	0.35
RE1096BBNB	Aluminio	□	12 W	1100 lm	127-220 V	4 000 K	25 000 h	Driver electrónico	LED Integrado	120°	80	0.95	30	125 mm	0.35
RE1097BBCB	Aluminio	□	18 W	1715 lm	127-220 V	3 000 K	25 000 h	Driver electrónico	LED Integrado	120°	80	0.9	30	150 mm	0.45
RE1097BBNB	Aluminio	□	18 W	1750 lm	127-220 V	4 000 K	25 000 h	Driver electrónico	LED Integrado	120°	80	0.95	30	150 mm	0.24
RE1098BBCB	Aluminio	□	25 W	2430 lm	127-220 V	3 000 K	25 000 h	Driver electrónico	LED Integrado	120°	80	0.95	30	200 mm	0.65
RE1098BBNB	Aluminio	□	25 W	2500 lm	127-220 V	4 000 K	25 000 h	Driver electrónico	LED Integrado	120°	80	0.95	30	200 mm	0.66
RE1090BBCB	Aluminio	□	7 W	640 lm	127-220 V	3 000 K	25 000 h	Driver electrónico	LED Integrado	120°	80	0.9	30	100X100 mm	0.32
RE1090BBNB	Aluminio	□	7 W	650 lm	127-220 V	4 000 K	25 000 h	Driver electrónico	LED Integrado	120°	80	0.9	30	100X100 mm	0.41
RE1091BBCB	Aluminio	□	12 W	1090 lm	127-220 V	3 000 K	25 000 h	Driver electrónico	LED Integrado	120°	80	0.9	30	125X125 mm	0.52
RE1091BBNB	Aluminio	□	12 W	1150 lm	127-220 V	4 000 K	25 000 h	Driver electrónico	LED Integrado	120°	80	0.9	30	125X125 mm	0.52
RE1092BBCB	Aluminio	□	18 W	1715 lm	127-220 V	3 000 K	25 000 h	Driver electrónico	LED Integrado	120°	80	0.9	30	150X150 mm	0.54
RE1092BBNB	Aluminio	□	18 W	1750 lm	127-220 V	4 000 K	25 000 h	Driver electrónico	LED Integrado	120°	80	0.95	30	150X150 mm	0.53
RE1093BBCB	Aluminio	□	25 W	2430 lm	127-220 V	3 000 K	25 000 h	Driver electrónico	LED Integrado	120°	80	0.95	30	200X200 mm	0.686
RE1093BBNB	Aluminio	□	25 W	2500 lm	127-220 V	4 000 K	25 000 h	Driver electrónico	LED Integrado	120°	80	0.95	30	200X200 mm	0.95

RE1116BBCA

LED 6 WATTS 560 LUMENS 3000K 120° ANGLULO APERTURA IP30 BLANCO

RE1116BBFA

LED 6 WATTS 560 LUMENS 6000K 120° ANGLULO APERTURA IP30 BLANCO

RE1116BBNA

LED 6 WATTS 560 LUMENS 4000K 120° ANGLULO APERTURA IP30 BLANCO

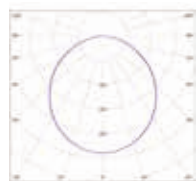

RE1117BBCA

LED 10 WATTS 970 LUMENS 3000K 120° ANGLULO APERTURA IP30 BLANCO

RE1117BBFA

LED 10 WATTS 970 LUMENS 6000K 120° ANGLULO APERTURA IP30 BLANCO

RE1117BBNA

LED 10 WATTS 970 LUMENS 4000K 120° ANGLULO APERTURA IP30 BLANCO

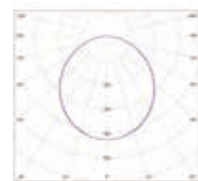

RE1118BBCA

LED 20 WATTS 1940 LUMENS 3000K 120° ANGLULO APERTURA IP30 BLANCO

RE1118BBFA

LED 20 WATTS 1940 LUMENS 6000K 120° ANGLULO APERTURA IP30 BLANCO

RE1118BBNA

LED 20 WATTS 1940 LUMENS 4000K 120° ANGLULO APERTURA IP30 BLANCO

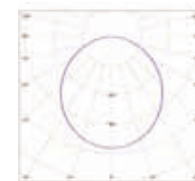

RE1111BBCA

LED 6 WATTS 560 LUMENS 3000K 120° ANGLULO APERTURA IP30 BLANCO

RE1111BBFA

LED 6 WATTS 560 LUMENS 6000K 120° ANGLULO APERTURA IP30 BLANCO

RE1111BBNA

LED 6 WATTS 560 LUMENS 4000K 120° ANGLULO APERTURA IP30 BLANCO

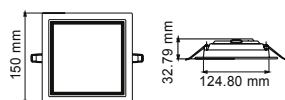
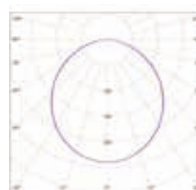

RE1112BBCA

LED 10 WATTS 970 LUMENS 3000K 120° ANGLULO APERTURA IP30 BLANCO

RE1112BBFA

LED 10 WATTS 970 LUMENS 6000K 120° ANGLULO APERTURA IP30 BLANCO

RE1112BBNA

LED 10 WATTS 970 LUMENS 4000K 120° ANGLULO APERTURA IP30 BLANCO

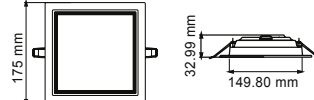
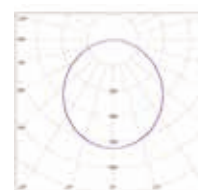

RE1113BBCA

LED 20 WATTS 1940 LUMENS 3000K 120° ANGLULO APERTURA IP30 BLANCO

RE1113BBFA

LED 20 WATTS 1940 LUMENS 6000K 120° ANGLULO APERTURA IP30 BLANCO

RE1113BBNA

LED 20 WATTS 1940 LUMENS 4000K 120° ANGLULO APERTURA IP30 BLANCO

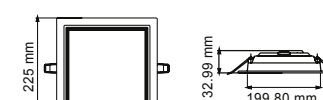
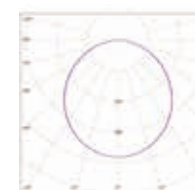
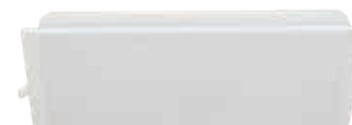

CÓDIGO	MATERIAL DE CUERPO	COLOR	POTENCIA	FLUJO LUMINOSO	ALIMENTACIÓN	TCC	VIDA ÚTIL (L80)	DRIVER	FUENTE DE LUZ	ÁNGULO DE APERTURA (VxH)	IRC	FP	IP	CORTE DE EMPOTRAMIENTO	PESO (KG)
RE1116BBCA	ABS	☐	6 W	560 lm	127-277 V	3 000 K	25 000 h	Driver electrónico	LED Integrado	120°	82	0.87	30	100 mm	0.25
RE1116BBFA	ABS	☐	6 W	560 lm	127-277 V	6 000 K	25 000 h	Driver electrónico	LED Integrado	120°	82	0.87	30	100 mm	0.25
RE1116BBNA	ABS	☐	6 W	560 lm	127-277 V	4 000 K	25 000 h	Driver electrónico	LED Integrado	120°	82	0.87	30	100 mm	0.25
RE1117BBCA	ABS	☐	10 W	970 lm	127-277 V	3 000 K	25 000 h	Driver electrónico	LED Integrado	120°	82	0.89	30	125 mm	0.42
RE1117BBFA	ABS	☐	10 W	970 lm	127-277 V	6 000 K	25 000 h	Driver electrónico	LED Integrado	120°	82	0.89	30	125 mm	0.42
RE1117BBNA	ABS	☐	10 W	970 lm	127-277 V	4 000 K	25 000 h	Driver electrónico	LED Integrado	120°	82	0.89	30	125 mm	0.42
RE1118BBCA	ABS	☐	20 W	1940 lm	127-277 V	3 000 K	25 000 h	Driver electrónico	LED Integrado	120°	82	0.91	30	200 mm	0.7
RE1118BBFA	ABS	☐	20 W	1940 lm	127-277 V	6 000 K	25 000 h	Driver electrónico	LED Integrado	120°	82	0.91	30	200 mm	0.7
RE1118BBNA	ABS	☐	20 W	1940 lm	127-277 V	4 000 K	25 000 h	Driver electrónico	LED Integrado	120°	82	0.91	30	200 mm	0.7
RE1111BBCA	ABS	☐	6 W	560 lm	127-277 V	3 000 K	25 000 h	Driver electrónico	LED Integrado	120°	82	0.89	30	100X100 mm	0.25
RE1111BBFA	ABS	☐	6 W	560 lm	127-277 V	6 000 K	25 000 h	Driver electrónico	LED Integrado	120°	82	0.89	30	100X100 mm	0.25
RE1111BBNA	ABS	☐	6 W	560 lm	127-277 V	4 000 K	25 000 h	Driver electrónico	LED Integrado	120°	82	0.89	30	100X100 mm	0.25
RE1112BBCA	ABS	☐	10 W	970 lm	127-277 V	3 000 K	25 000 h	Driver electrónico	LED Integrado	120°	82	0.90	30	125X125 mm	0.42
RE1112BBFA	ABS	☐	10 W	970 lm	127-277 V	6 000 K	25 000 h	Driver electrónico	LED Integrado	120°	82	0.90	30	125X125 mm	0.42
RE1112BBNA	ABS	☐	10 W	970 lm	127-277 V	4 000 K	25 000 h	Driver electrónico	LED Integrado	120°	82	0.90	30	125X125 mm	0.42
RE1113BBCA	ABS	☐	20 W	1940 lm	127-277 V	3 000 K	25 000 h	Driver electrónico	LED Integrado	120°	82	0.91	30	200X200 mm	0.7
RE1113BBFA	ABS	☐	20 W	1940 lm	127-277 V	6 000 K	25 000 h	Driver electrónico	LED Integrado	120°	82	0.91	30	200X200 mm	0.7
RE1113BBNA	ABS	☐	20 W	1940 lm	127-277 V	4 000 K	25 000 h	Driver electrónico	LED Integrado	120°	82	0.91	30	200X200 mm	0.7

RE1054BBCB

LED	9 WATTS	660 LUMENS	3000K	110° ÁNGULO APERTURA	IP51	BLANCO
-----	---------	------------	-------	-------------------------	------	--------

RE1054BBFB

LED	9 WATTS	725 LUMENS	6500K	110° ÁNGULO APERTURA	IP51	BLANCO
-----	---------	------------	-------	-------------------------	------	--------

RE1054BBNB

LED	9 WATTS	690 LUMENS	4000K	110° ÁNGULO APERTURA	IP51	BLANCO
-----	---------	------------	-------	-------------------------	------	--------

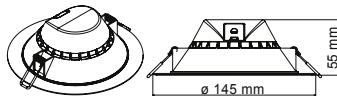
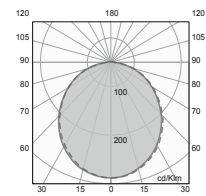

RE1055BBCB

LED	13 WATTS	1100 LUMENS	3000K	110° ÁNGULO APERTURA	IP51	BLANCO
-----	----------	-------------	-------	-------------------------	------	--------

RE1055BBFB

LED	13 WATTS	1160 LUMENS	6500K	110° ÁNGULO APERTURA	IP51	BLANCO
-----	----------	-------------	-------	-------------------------	------	--------

RE1055BBNB

LED	13 WATTS	1100 LUMENS	4000K	110° ÁNGULO APERTURA	IP51	BLANCO
-----	----------	-------------	-------	-------------------------	------	--------

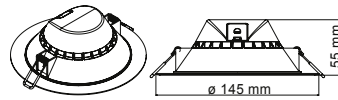
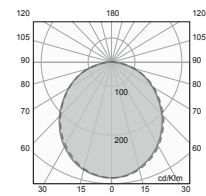

RE1058BBCB

LED	21 WATTS	1520 LUMENS	3000K	110° ÁNGULO APERTURA	IP51	BLANCO
-----	----------	-------------	-------	-------------------------	------	--------

RE1058BBFB

LED	21 WATTS	1670 LUMENS	6500K	110° ÁNGULO APERTURA	IP51	BLANCO
-----	----------	-------------	-------	-------------------------	------	--------

RE1058BBNB

LED	21 WATTS	1670 LUMENS	4000K	110° ÁNGULO APERTURA	IP51	BLANCO
-----	----------	-------------	-------	-------------------------	------	--------

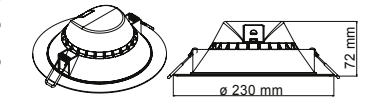
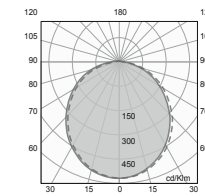

CO1245BBNB

LED	18 WATTS	2020 LUMENS	4000K	90° ÁNGULO APERTURA	IP54	BLANCO
-----	----------	-------------	-------	------------------------	------	--------

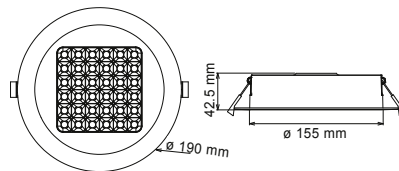
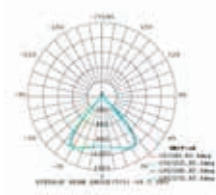

CO1246BBNB

LED	25 WATTS	2600 LUMENS	4000K	90° ÁNGULO APERTURA	IP54	BLANCO
-----	----------	-------------	-------	------------------------	------	--------

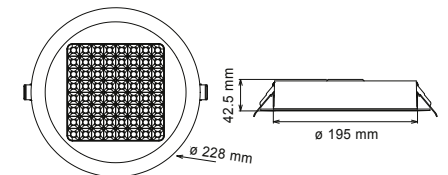
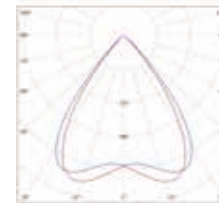

CÓDIGO	MATERIAL DE CUERPO	COLOR	POTENCIA	FLUJO LUMINOSO	ALIMENTACIÓN	TCC	VIDA ÚTIL (L80)	DRIVER	FUENTE DE LUZ	ÁNGULO DE APERTURA (VxH)	IRC	FP	IP	CORTE DE EMPOTRAMIENTO	PESO (KG)
RE1054BBCB	Aluminio	□	9 W	660 lm	127-220 V	3 000 K	25 000 h	Driver electrónico	LED Integrado	110°	80	0.95	51	115 mm	0.27
RE1054BBFB	Aluminio	□	9 W	725 lm	127-220 V	6 500 K	25 000 h	Driver electrónico	LED Integrado	110°	80	0.95	51	115 mm	0.27
RE1054BBNB	Aluminio	□	9 W	690 lm	127-220 V	4 000 K	25 000 h	Driver electrónico	LED Integrado	110°	80	0.95	51	115 mm	0.27
RE1055BBCB	Aluminio	□	13 W	1100 lm	127-220 V	3 000 K	25 000 h	Driver electrónico	LED Integrado	110°	80	0.9	51	115 mm	0.38
RE1055BBFB	Aluminio	□	13 W	1160 lm	127-220 V	6 500 K	25 000 h	Driver electrónico	LED Integrado	110°	80	0.9	51	115 mm	0.38
RE1055BBNB	Aluminio	□	13 W	1100 lm	127-220 V	4 000 K	25 000 h	Driver electrónico	LED Integrado	110°	80	0.9	51	115 mm	0.38
RE1058BBCB	Aluminio	□	21 W	1520 lm	127-220 V	3 000 K	25 000 h	Driver electrónico	LED Integrado	110°	80	0.9	51	180 mm	0.588
RE1058BBFB	Aluminio	□	21 W	1670 lm	127-220 V	6 500 K	25 000 h	Driver electrónico	LED Integrado	110°	80	0.9	51	180 mm	0.588
CO1245BBNB	Aluminio	□	18 W	2020 lm	127-220 V	4 000 K	25 000 h	Driver electrónico	LED Integrado	90°	80	0.9	54	155 mm	0.57
CO1246BBNB	Aluminio	□	25 W	2600 lm	127-220 V	4 000 K	25 000 h	Driver electrónico	LED Integrado	90°	80	0.9	54	195 mm	0.82

CO1148BBCA

LED 10 WATTS 696 LUMENS 3000K 120° ANGULO APERTURA IP20 BLANCO

NUEVO

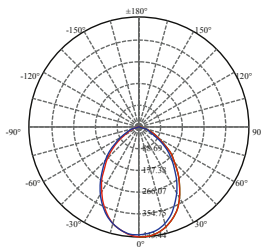
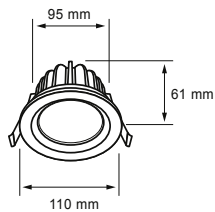

CO1149BBCA

LED 25 WATTS 1815 LUMENS 3000K 120° ANGULO APERTURA IP20 BLANCO

NUEVO

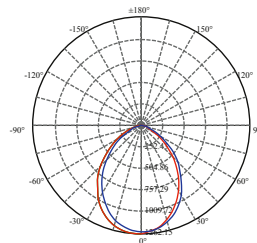
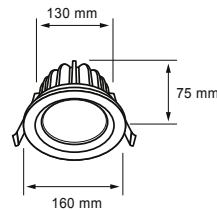

RE1048BBCA

LED 35 WATTS 1925 LUMENS 3000K 30° ANGULO APERTURA IP20 BLANCO



WALL WASHER

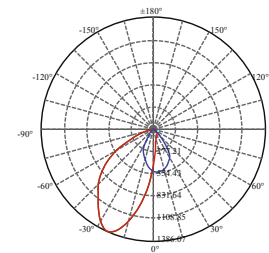
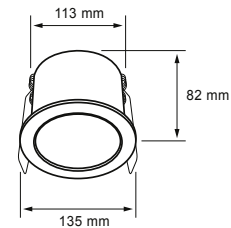

CÓDIGO	MATERIAL DE CUERPO	COLOR	POTENCIA	FLUJO LUMINOSO	ALIMENTACIÓN	TCC	VIDA ÚTIL(L80)	DRIVER	FUENTE DE LUZ	ÁNGULO DE APERTURA (VxH)	IRC	FP	IP	CORTE DE EMPOTRAMIENTO	PESO (KG)
CO1148BBCA	Aluminio	□	10 W	696 lm	100-277V ~	3 000 K	50 000 h	Driver electrónico	LED Integrado	120°	90	0.9	20	95 mm	0.79
CO1149BBCA	Aluminio	□	25 W	1815 lm	100-277V ~	3 000 K	50 000 h	Driver electrónico	LED Integrado	120°	90	0.9	20	130 mm	0.79
RE1048BBCA	Aluminio	□	35 W	1925 lm	100-277V ~	3 000 K	50 000 h	Driver electrónico	LED Integrado	WW 30°	90	0.9	20	120 mm	1

CO1635NBCA

LED 44 WATTS 2750 LUMENS 3000K 20° ANGULO APERTURA IP30 NEGRO

CO1635NBNA

LED 44 WATTS 2750 LUMENS 4000K 20° ANGULO APERTURA IP30 NEGRO

CO1635NBCB

LED 44 WATTS 4100 LUMENS 3000K 20° ANGULO APERTURA IP30 NEGRO



CO1636NBCB

LED 2X44 WATTS 8200 LUMENS 3000K 20° ANGULO APERTURA IP30 NEGRO



CO1634NBCB

LED 3X44 WATTS 12176 LUMENS 3000K 20° ANGULO APERTURA IP30 NEGRO

CO1634NBNB

LED 3X44 WATTS 12176 LUMENS 4000K 20° ANGULO APERTURA IP30 NEGRO

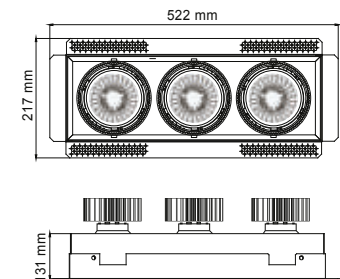
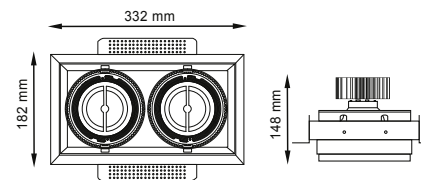
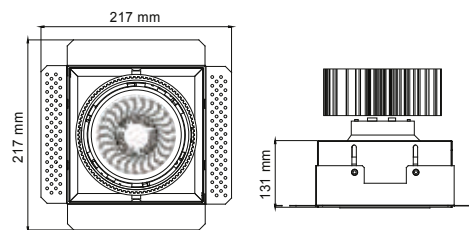
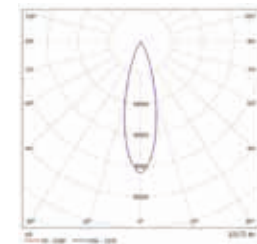
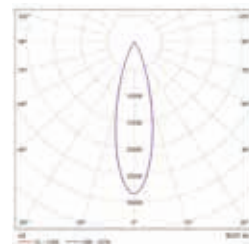
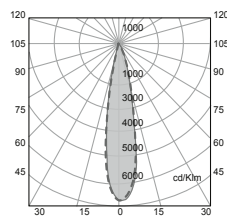

CÓDIGO	MATERIAL DE CUERPO	COLOR	POTENCIA	FLUJO LUMINOSO	ALIMENTACIÓN	TCC	VIDA ÚTIL (L80)	DRIVER	FUENTE DE LUZ	ÁNGULO DE APERTURA (VxH)	IRC	FP	IP	CORTE DE EMPOTRAMIENTO	PESO (KG)
CO1635NBCA	Acero	■	44 W	2750 lm	127-277 V	3 000 K	25 000 h	Driver electrónico	LED Integrado	20°	90	0.9	30	155X155 mm	2.603
CO1635NBNA	Acero	■	44 W	2750 lm	127-277 V	4 000 K	25 000 h	Driver electrónico	LED Integrado	20°	90	0.9	30	155X155 mm	2.603
CO1635NBCB	Acero	■	44 W	4100 lm	127-240 V	3 000 K	25 000 h	Driver electrónico	LED Integrado	20°	90	0.9	30	158X158 mm	2.3
CO1636NBCB	Acero	■	2X44 W	8200 lm	127-240 V	3 000 K	25 000 h	Driver electrónico	LED Integrado	20°	90	0.9	30	310X156 mm	3.7
CO1634NBCB	Acero	■	3X44 W	12176 lm	127-240 V	3 000 K	25 000 h	Driver electrónico	LED Integrado	20°	90	0.9	30	460X156 mm	5.5
CO1634NBNB	Acero	■	3X44 W	12176 lm	127-240 V	4 000 K	25 000 h	Driver electrónico	LED Integrado	20°	90	0.9	30	460X156 mm	5.5

CO1637NBCA

LED 1X17 WATTS 1367 LUMENS 2700K 24° ANGLULO APERTURA IP30 NEGRO

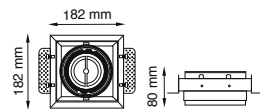
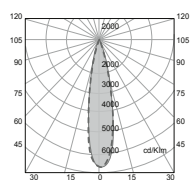

CO1638NBCA

LED 2X17 WATTS 2700 LUMENS 2700K 24° ANGLULO APERTURA IP30 NEGRO

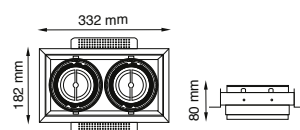
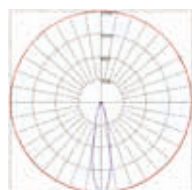

CO1639NBCA

LED 3X17 WATTS 4080 LUMENS 2700K 24° ANGLULO APERTURA IP30 NEGRO

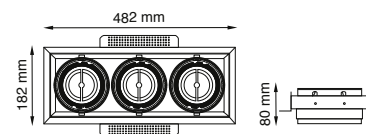
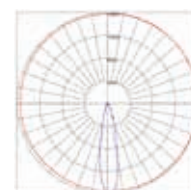

CO1739NBCA

LED 3X17 WATTS 4290 LUMENS 2700K 24° ANGLULO APERTURA IP30 NEGRO

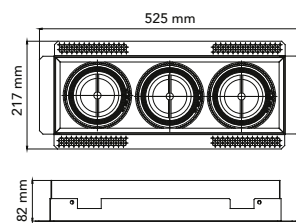
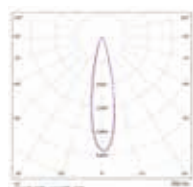

CO1181B00D

IP30 BLANCO

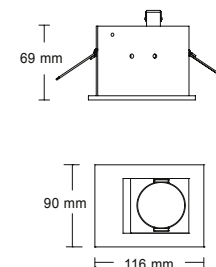
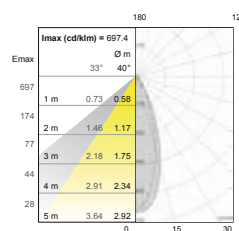

CÓDIGO	MATERIAL DE CUERPO	COLOR	POTENCIA	FLUJO LUMINOSO	ALIMENTACIÓN	TCC	VIDA ÚTIL (L80)	FUENTE DE LUZ	ÁNGULO DE APERTURA (VxH)	IRC	FP	IP	CORTE DE EMPOTRAMIENTO	PESO (KG)
CO1637NBCA	Acero	■	1X17 W	1367 lm	127-277 V	■ 2700 K	25 000 h	AR111 Integrada	24°	80	0.9	30	155X155 mm	2.603
CO1638NBCA	Acero	■	2X17 W	2700 lm	127-277 V	■ 2700 K	25 000 h	AR111 Integrada	24°	80	0.9	30	305X156 mm	2.603
CO1639NBCA	Acero	■	3X17 W	4080 lm	127-277 V	■ 2700 K	25 000 h	AR111 Integrada	24°	80	0.9	30	460X156 mm	2.603
CO1739NBCA	Acero	■	3X17 W	4290 lm	127-277 V	■ 2700 K	25 000 h	AR111 Integrada	24°	80	0.9	30	460X156 mm	6.7
CO1181B00D	Acero	□	-	-	-	-	-	No incluye lámpara	-	-	-	30	106X70 mm	0.4

CO1625BBCA

LED 44 WATTS 2750 LUMENS 3000K 20° ANGLULO APERTURA IP30 BLANCO

CO1625BBCB

LED 44 WATTS 4084 LUMENS 3000K 20° ANGLULO APERTURA IP30 BLANCO

CO1625BBNA

LED 44 WATTS 2750 LUMENS 4000K 20° ANGLULO APERTURA IP30 BLANCO

CO1625BBNB

LED 44 WATTS 4084 LUMENS 4000K 20° ANGLULO APERTURA IP30 BLANCO

*Compatible con HOUSING-AC1068N

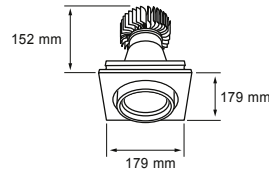
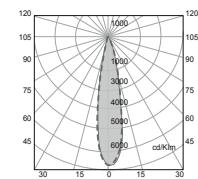

CO1629NBCA

LED 44 WATTS 2750 LUMENS 3000K 20° ANGLULO APERTURA IP30 NEGRO

CO1629NBCB

LED 44 WATTS 4084 LUMENS 3000K 20° ANGLULO APERTURA IP30 NEGRO

CO1629NBNA

LED 44 WATTS 2750 LUMENS 4000K 20° ANGLULO APERTURA IP30 NEGRO

CO1629BBNB

LED 44 WATTS 4084 LUMENS 4000K 20° ANGLULO APERTURA IP30 NEGRO

*Compatible con HOUSING-AC1068N

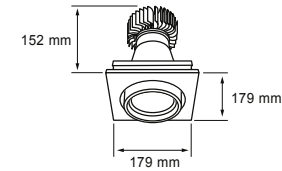
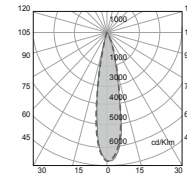

CO1162BBCA

LED 20 WATTS 1600 LUMENS 3000K 24° ANGLULO APERTURA IP40 BLANCO

CO1162NBCA

LED 20 WATTS 1300 LUMENS 3000K 24° ANGLULO APERTURA IP40 NEGRO

CO1162BBCB

LED 1X17 WATTS 1367 LUMENS 2700K 24° ANGLULO APERTURA IP30 BLANCO

CO1162NBCB

LED 1X17 WATTS 1400 LUMENS 2700K 24° ANGLULO APERTURA IP30 NEGRO

*Compatible con HOUSING-AC1068N

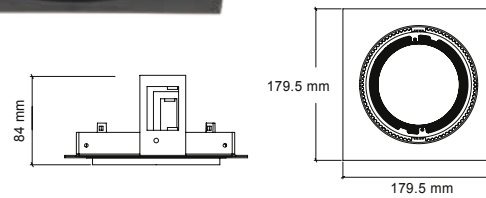
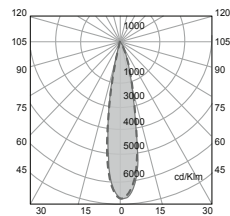

AC1068N

*Sólo compatible con modelos CO1162

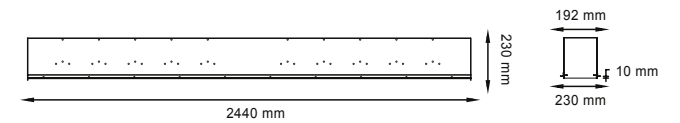

CÓDIGO	MATERIAL DE CUERPO	COLOR	POTENCIA	FLUJO LUMINOSO	ALIMENTACIÓN	TCC	VIDA ÚTIL (L80)	DRIVER	FUENTE DE LUZ	ÁNGULO DE APERTURA (VxH)	IRC	FP	IP	CORTE DE EMPOTRAMIENTO	PESO (KG)
CO1625BBCA	ABS	□	44 W	2750 lm	127-277 V	3 000 K	25 000 h	Driver electrónico	LED Integrado	20°	90	0.9	30	163X163 mm	2.603
CO1625BBCB	ABS	□	44 W	4084 lm	127-240 V	3 000 K	50 000 h	Driver electrónico	LED Integrado	20°	80	0.9	30	163X163 mm	1.16
CO1625BBNA	ABS	□	44 W	2750 lm	127-277 V	4 000 K	50 000 h	Driver electrónico	LED Integrado	20°	90	0.9	30	163X163 mm	2.603
CO1625BBNB	ABS	□	44 W	4084 lm	127-240 V	4 000 K	50 000 h	Driver electrónico	LED Integrado	20°	80	0.9	30	163X163 mm	1.16
CO1629NBCA	ABS	■	44 W	2750 lm	127-277 V	3 000 K	50 000 h	Driver electrónico	LED Integrado	20°	90	0.9	30	163X163 mm	2.603
CO1629NBCB	ABS	■	44 W	4084 lm	127-240 V	3 000 K	50 000 h	Driver electrónico	LED Integrado	20°	80	0.9	30	163X163 mm	1.16
CO1629NBNA	ABS	■	44 W	2750 lm	127-277 V	4 000 K	50 000 h	Driver electrónico	LED Integrado	20°	90	0.9	30	163X163 mm	2.603
CO1629BBNB	ABS	■	44 W	4084 lm	127-240 V	4 000 K	50 000 h	Driver electrónico	LED Integrado	20°	80	0.9	30	163X163 mm	1.16
CO1162BBCA	ABS	□	1X17 W	1367 lm	127-277 V	2 700 K	25 000 h	-	AR111	24°	80	0.9	30	163X163 mm	1.4
CO1162NBCA	ABS	■	1X17 W	1400 lm	100-240 V	2 700 K	25 000 h	-	AR111	24°	80	0.9	30	163X163 mm	1.4
CO1162BBCB	Aluminio	□	20 W	1600 lm	100-240 V	3 000 K	30 000 h	Driver electrónico	LED Integrado	24°	90	0.9	40	NA	0.5
CO1162NBCB	Aluminio	■	20 W	1300 lm	100-240 V	3 000 K	30 000 h	Driver electrónico	LED Integrado	24°	90	0.9	40	NA	0.5
AC1068N	Acero	■	-	-	-	-	-	-	-	-	-	-	30	NA	12.8



CO1137BBCA

LED 30 WATTS 2815 LUMENS 3000K 24° ANGLULO APERTURA IP30 BLANCO



DIRIGIBLE

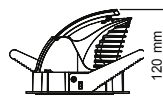
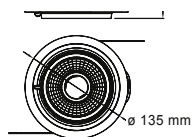
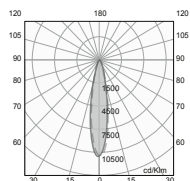

CO1150BBNA

LED 25 WATTS 2068 LUMENS 4000K 90° ANGLULO APERTURA IP54 BLANCO



TCC AJUSTABLE CON INTERRUPTOR

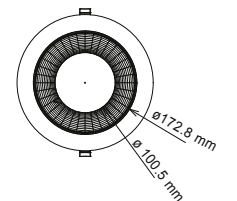
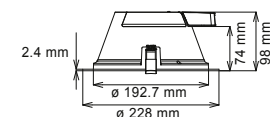
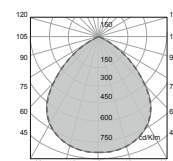

CÓDIGO	MATERIAL DE CUERPO	COLOR	POTENCIA	FLUJO LUMINOSO	ALIMENTACIÓN	TCC	VIDA ÚTIL (L80)	DRIVER	FUENTE DE LUZ	ÁNGULO DE APERTURA (VxH)	IRC	FP	IP	CORTE DE EMPOTRAMIENTO	PESO (KG)
CO1137BBCA	Aluminio	□	30 W	2815 lm	127-277 V	3 000 K	25 000 h	Driver electrónico	LED Integrado	24°	80	0.8	30	125 mm	0.86
CO1150BBNA	Aluminio	□	25 W	2068 lm	127-277 V	Ajustable	25 000 h	Driver electrónico	LED Integrado	90°	80	0.95	54	200 mm	1.2

CO1185BBCA

LED 13 WATTS 1425 LUMENS 3000K 30° ANGULO APERTURA IP20 B/N NUEVO

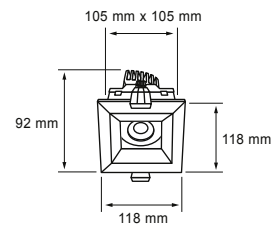
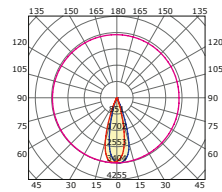

CO1186BBCA

LED 26 WATTS 2850 LUMENS 3000K 30° ANGULO APERTURA IP20 B/N NUEVO

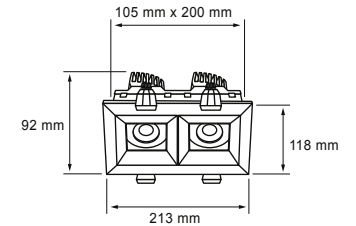
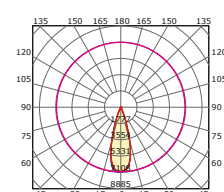
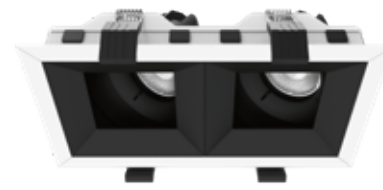

CO1187BBCA

LED 39 WATTS 4275 LUMENS 3000K 30° ANGULO APERTURA IP20 B/N NUEVO

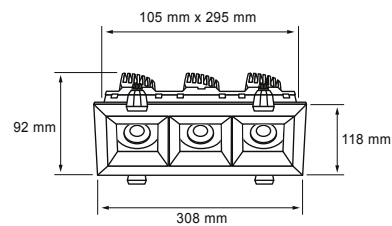
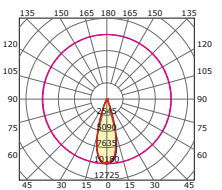
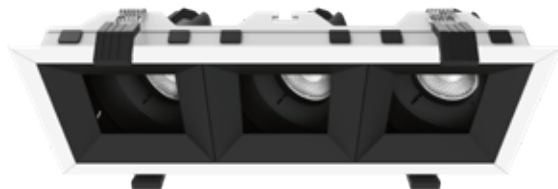

CO1188BBCA

LED 52 WATTS 5700 LUMENS 3000K 30° ANGULO APERTURA IP20 B/N NUEVO

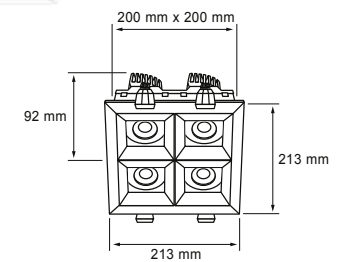
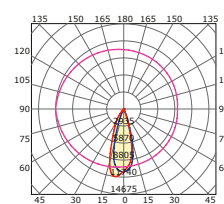
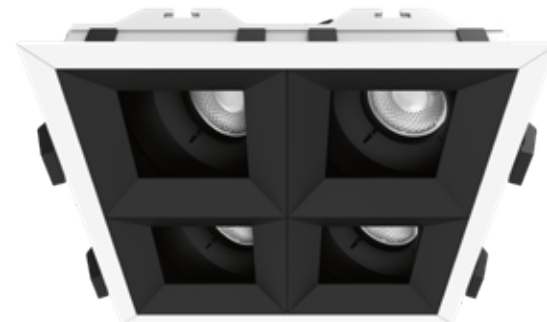

CÓDIGO	MATERIAL DE CUERPO	COLOR	POTENCIA	FLUJO LUMINOSO	ALIMENTACIÓN	TCC	VIDA ÚTIL (L80)	DRIVER	FUENTE DE LUZ	ÁNGULO DE APERTURA (VxH)	IRC	FP	IP	CORTE DE EMPOTRAMIENTO	PESO (KG)
CO1185BBCA	Aluminio	■	13 W	1425 lm	100-277V ~	3 000 K	30 000 h	Driver electrónico	LED Integrado	30°	90	0.9	20	105 mm x 105 mm	0.2
CO1186BBCA	Aluminio	■	26 W	2850 lm	100-277V ~	3 000 K	30 000 h	Driver electrónico	LED Integrado	30°	90	0.9	20	200 mm x 105 mm	0.33
CO1187BBCA	Aluminio	■	39 W	4275 lm	100-277V ~	3 000 K	30 000 h	Driver electrónico	LED Integrado	30°	90	0.9	20	295 mm x 105 mm	0.8
CO1188BBCA	Aluminio	■	52 W	5700 lm	100-277V ~	3 000 K	30 000 h	Driver electrónico	LED Integrado	30°	90	0.9	20	200 mm x 200 mm	1.1

CO1171NBCA

LED 26 WATTS 2850 LUMENS 3000K 30° ANGULO APERTURA IP20 NEGRO NUEVO

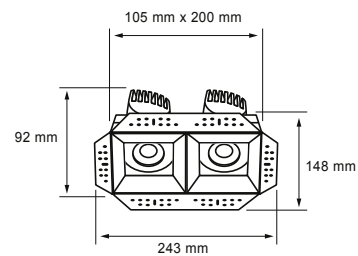
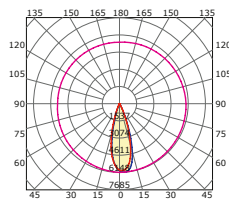
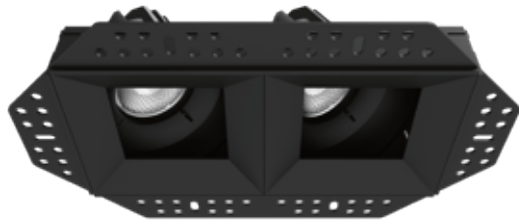

CO1176NBCA

LED 52 WATTS 5700 LUMENS 3000K 30° ANGULO APERTURA IP20 NEGRO NUEVO

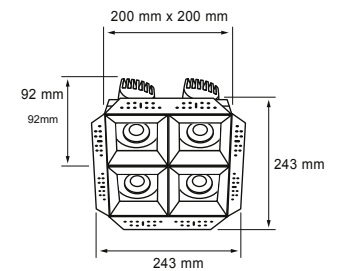
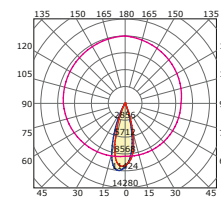
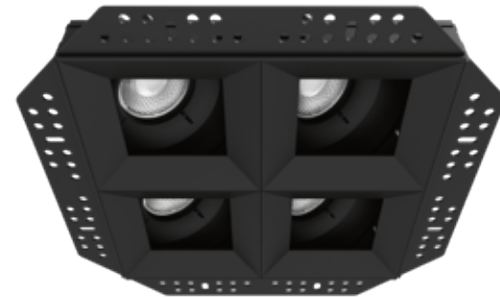

CO1172NBCA

LED 39 WATTS 4275 LUMENS 3000K 30° ANGULO APERTURA IP20 NEGRO NUEVO

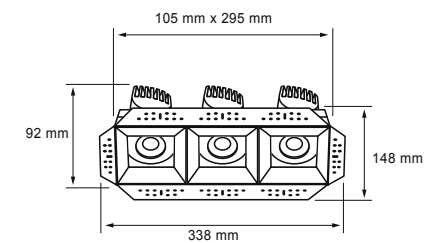
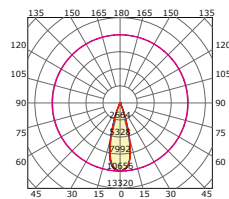
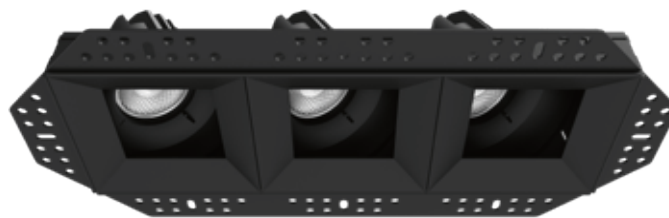

CÓDIGO	MATERIAL DE CUERPO	COLOR	POTENCIA	FLUJO LUMINOSO	ALIMENTACIÓN	TCC	VIDA ÚTIL (L80)	DRIVER	FUENTE DE LUZ	ÁNGULO DE APERTURA (VxH)	IRC	FP	IP	CORTE DE EMPOTRAMIENTO	PESO (KG)
CO1171NBCA	Aluminio	■	26 W	2850 lm	100-277V ~	3 000 K	30 000 h	Driver electrónico	LED Integrado	30°	90	0.9	20	200 mm x 105 mm	0.33
CO1176NBCA	Aluminio	■	52 W	5700 lm	100-277V ~	3 000 K	30 000 h	Driver electrónico	LED Integrado	30°	90	0.9	20	200 mm x 200 mm	0.89
CO1172NBCA	Aluminio	■	39 W	4275 lm	100-277V ~	3 000 K	30 000 h	Driver electrónico	LED Integrado	30°	90	0.9	20	295 mm x 105 mm	0.62

CO1055BBCB

LED 5 WATTS 325 LUMENS 3000K 30° ANGULO APERTURA IP40 BLANCO

NUEVO

CO1055NBCB

LED 5 WATTS 325 LUMENS 3000K 30° ANGULO APERTURA IP40 NEGRO

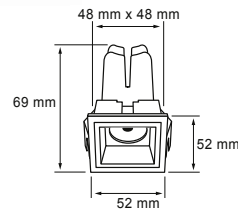
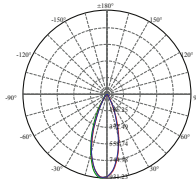

CO1056BBCB

LED 10 WATTS 650 LUMENS 3000K 30° ANGULO APERTURA IP40 BLANCO

NUEVO

CO1056NBCB

LED 10 WATTS 650 LUMENS 3000K 30° ANGULO APERTURA IP40 NEGRO

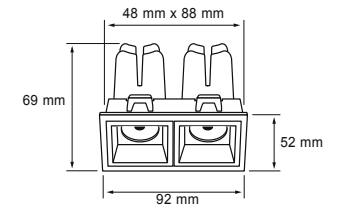
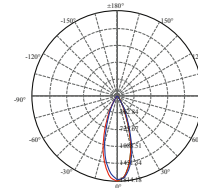

CO1057BBCB

LED 15 WATTS 975 LUMENS 3000K 30° ANGULO APERTURA IP40 BLANCO

NUEVO

CO1057NBCB

LED 15 WATTS 975 LUMENS 3000K 30° ANGULO APERTURA IP40 NEGRO

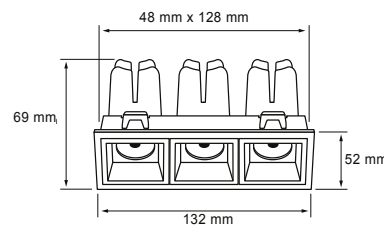
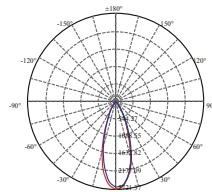

CO1058BBCB

LED 20 WATTS 1300 LUMENS 3000K 30° ANGULO APERTURA IP40 BLANCO

NUEVO

CO1058NBCB

LED 20 WATTS 1300 LUMENS 3000K 30° ANGULO APERTURA IP40 NEGRO

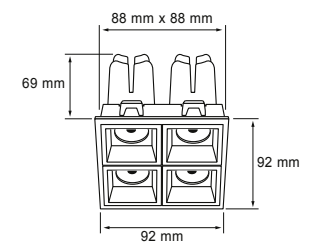
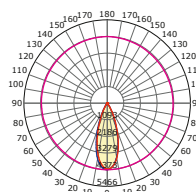

CÓDIGO	MATERIAL DE CUERPO	COLOR	POTENCIA	FLUJO LUMINOSO	ALIMENTACIÓN	TCC	VIDA ÚTIL (L80)	DRIVER	FUENTE DE LUZ	ÁNGULO DE APERTURA (VxH)	IRC	FP	IP	CORTE DE EMPOTRAMIENTO	PESO (KG)
CO1055BBCB	Aluminio	Blanco	5 W	325 lm	100-240V ~	3 000 K	30 000 h	Driver electrónico	LED Integrado	30°	90	0.9	40	48 mm x 48 mm	0.14
CO1055NBCB	Aluminio	Negro	5 W	325 lm	100-240V ~	3 000 K	30 000 h	Driver electrónico	LED Integrado	30°	90	0.9	40	48 mm x 48 mm	0.14
CO1056BBCB	Aluminio	Blanco	10 W	650 lm	100-240V ~	3 000 K	30 000 h	Driver electrónico	LED Integrado	30°	90	0.9	40	48 mm x 88 mm	0.27
CO1056NBCB	Aluminio	Negro	10 W	650 lm	100-240V ~	3 000 K	30 000 h	Driver electrónico	LED Integrado	30°	90	0.9	40	48 mm x 88 mm	0.27
CO1057BBCB	Aluminio	Blanco	15 W	975 lm	100-240V ~	3 000 K	30 000 h	Driver electrónico	LED Integrado	30°	90	0.9	40	48 mm x 128 mm	0.38
CO1057NBCB	Aluminio	Negro	15 W	975 lm	100-240V ~	3 000 K	30 000 h	Driver electrónico	LED Integrado	30°	90	0.9	40	48 mm x 128 mm	0.38
CO1058BBCB	Aluminio	Blanco	20 W	1300 lm	100-240V ~	3 000 K	30 000 h	Driver electrónico	LED Integrado	30°	90	0.9	40	88 mm x 88 mm	0.48
CO1058NBCB	Aluminio	Negro	20 W	1300 lm	100-240V ~	3 000 K	30 000 h	Driver electrónico	LED Integrado	30°	90	0.9	40	88 mm x 88 mm	0.48

RE1077BBCA

LED 21 WATTS 1440 LUMENS 3000K 24° ANGLULO APERTURA IP20 BLANCO

NUEVO

RE1077NBCA

LED 21 WATTS 1440 LUMENS 3000K 24° ANGLULO APERTURA IP20 NEGRO

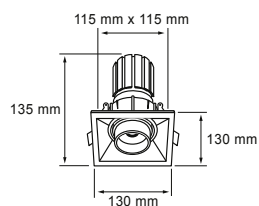
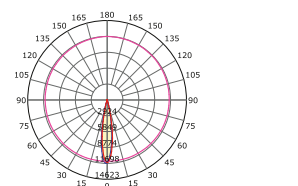

RE1078BBCA

LED 42 WATTS 2880 LUMENS 3000K 24° ANGLULO APERTURA IP20 BLANCO

NUEVO

RE1078NBCA

LED 42 WATTS 2880 LUMENS 3000K 24° ANGLULO APERTURA IP20 NEGRO

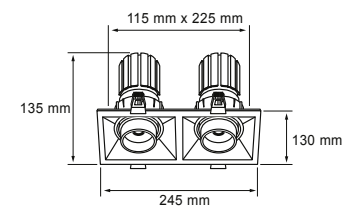
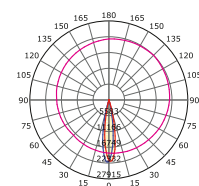

RE1079BBCA

LED 63 WATTS 4320 LUMENS 3000K 24° ANGLULO APERTURA IP20 BLANCO

NUEVO

RE1079NBCA

LED 63 WATTS 4320 LUMENS 3000K 24° ANGLULO APERTURA IP20 NEGRO

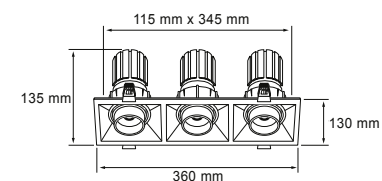
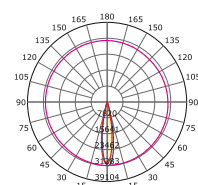

CÓDIGO	MATERIAL DE CUERPO	COLOR	POTENCIA	FLUJO LUMINOSO	ALIMENTACIÓN	TCC	VIDA ÚTIL (L80)	DRIVER	FUENTE DE LUZ	ÁNGULO DE APERTURA (VxH)	IRC	FP	IP	CORTE DE EMPOTRAMIENTO	PESO (KG)
RE1077BBCA	Aluminio	□	21 W	1440 lm	100-277V ~	3 000 K	30 000 h	Driver electrónico	LED Integrado	24°	90	0.9	20	115 mm x 115 mm	0.75
RE1077NBCA	Aluminio	■	21 W	1440 lm	100-277V ~	3 000 K	30 000 h	Driver electrónico	LED Integrado	24°	90	0.9	20	115 mm x 115 mm	0.75
RE1078BBCA	Aluminio	□	63 W	4320 lm	100-277V ~	3 000 K	30 000 h	Driver electrónico	LED Integrado	24°	90	0.9	20	225 mm x 115 mm	1.49
RE1078NBCA	Aluminio	■	63 W	4320 lm	100-277V ~	3 000 K	30 000 h	Driver electrónico	LED Integrado	24°	90	0.9	20	225 mm x 115 mm	1.49
RE1079BBCA	Aluminio	□	63 W	4320 lm	100-277V ~	3 000 K	30 000 h	Driver electrónico	LED Integrado	24°	90	0.9	20	345 mm x 115 mm	2.18
RE1079NBCA	Aluminio	■	63 W	4320 lm	100-277V ~	3 000 K	30 000 h	Driver electrónico	LED Integrado	24°	90	0.9	20	345 mm x 115 mm	2.18

RE1304BBCB

LED 35 WATTS 2640 LUMENS 3000K 24° ANGLULO APERTURA IP40 BLANCO

NUEVO

RE1304NBCB

LED 35 WATTS 2640 LUMENS 3000K 24° ANGLULO APERTURA IP40 NEGRO

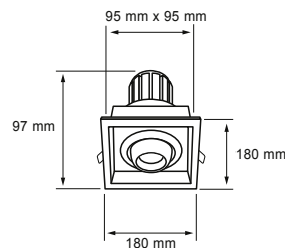
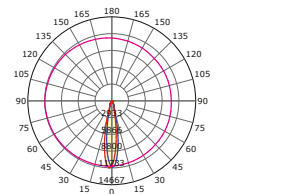

RE1302BBCB

LED 70 WATTS 5280 LUMENS 3000K 24° ANGLULO APERTURA IP40 BLANCO

NUEVO

RE1302NBCB

LED 70 WATTS 5280 LUMENS 3000K 24° ANGLULO APERTURA IP40 NEGRO

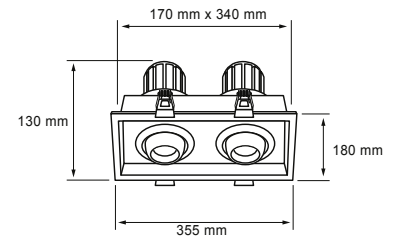
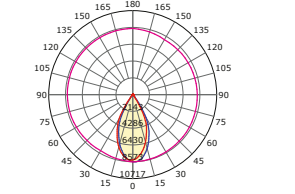

RE1309BBCB

LED 13 WATTS 1040 LUMENS 3000K 24° ANGLULO APERTURA IP40 BLANCO

NUEVO

RE1309NBCB

LED 13 WATTS 1040 LUMENS 3000K 24° ANGLULO APERTURA IP40 NEGRO

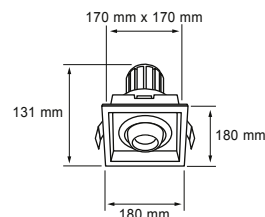
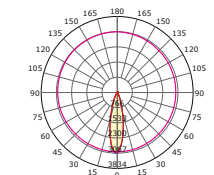

RE1306BBCB

LED 30 WATTS 2400 LUMENS 3000K 24° ANGLULO APERTURA IP40 BLANCO

NUEVO

RE1306NBCB

LED 30 WATTS 2400 LUMENS 3000K 24° ANGLULO APERTURA IP40 NEGRO

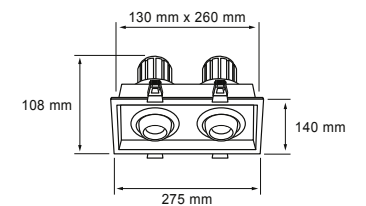
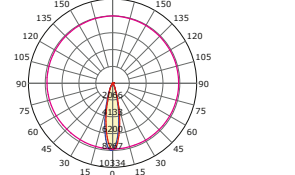

CÓDIGO	MATERIAL DE CUERPO	COLOR	POTENCIA	FLUJO LUMINOSO	ALIMENTACIÓN	TCC	VIDA ÚTIL (L80)	DRIVER	FUENTE DE LUZ	ÁNGULO DE APERTURA (VxH)	IRC	FP	IP	CORTE DE EMPOTRAMIENTO	PESO (KG)
RE1304BBCB	Aluminio	Blanco	35 W	2640 lm	100-240V ~	3 000 K	30 000 h	Driver electrónico	LED Integrado	24°	90	0.9	40	170 mm x 170 mm	1.28
RE1304NBCB	Aluminio	Negro	35 W	2640 lm	100-240V ~	3 000 K	30 000 h	Driver electrónico	LED Integrado	24°	90	0.9	40	170 mm x 170 mm	1.28
RE1302BBCB	Aluminio	Blanco	70 W	5280 lm	100-240V ~	3 000 K	30 000 h	Driver electrónico	LED Integrado	24°	90	0.9	40	340 mm x 170 mm	2.54
RE1302NBCB	Aluminio	Negro	70 W	5280 lm	100-240V ~	3 000 K	30 000 h	Driver electrónico	LED Integrado	24°	90	0.9	40	340 mm x 170 mm	2.54
RE1309BBCB	Aluminio	Blanco	13 W	1040 lm	100-240V ~	3 000 K	30 000 h	Driver electrónico	LED Integrado	24°	90	0.9	40	95 mm x 95 mm	0.42
RE1309NBCB	Aluminio	Negro	13 W	1040 lm	100-240V ~	3 000 K	30 000 h	Driver electrónico	LED Integrado	24°	90	0.9	40	95 mm x 95 mm	0.42
RE1306BBCB	Aluminio	Blanco	30 W	2400 lm	100-240V ~	3 000 K	30 000 h	Driver electrónico	LED Integrado	24°	90	0.9	40	260 mm x 130 mm	1.13
RE1306NBCB	Aluminio	Negro	30 W	2400 lm	100-240V ~	3 000 K	30 000 h	Driver electrónico	LED Integrado	24°	90	0.9	40	260 mm x 130 mm	1.13

RE1070BBCB

LED 15 WATTS 1200 LUMENS 3000K 24° ANGULO APERTURA IP40 BLANCO

NUEVO

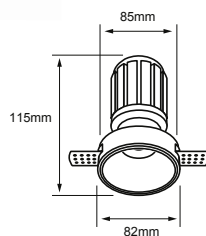
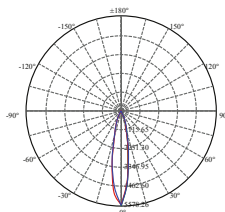

RE1074BBCB

LED 20 WATTS 1600 LUMENS 3000K 24° ANGULO APERTURA IP40 BLANCO

NUEVO

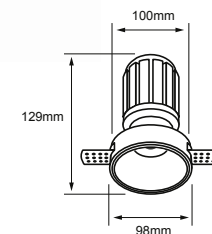
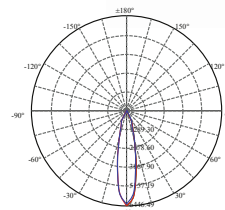

RE1073BBCB

LED 15 WATTS 1200 LUMENS 3000K 24° ANGULO APERTURA IP40 BLANCO

NUEVO

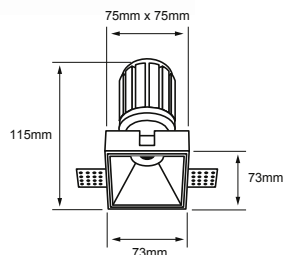
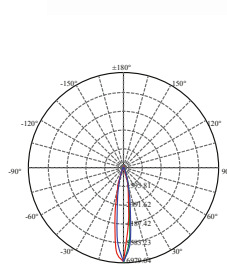

RE1077BBCB

LED 20 WATTS 1600 LUMENS 3000K 24° ANGULO APERTURA IP40 BLANCO

NUEVO

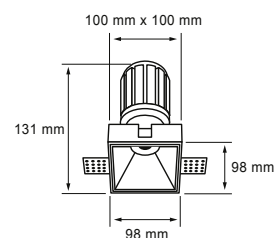
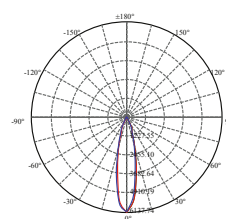

RE1078BBCB

LED 30 WATTS 2400 LUMENS 3000K 24° ANGULO APERTURA IP40 BLANCO

NUEVO

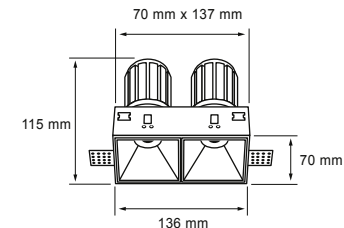
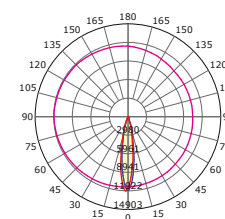

CÓDIGO	MATERIAL DE CUERPO	COLOR	POTENCIA	FLUJO LUMINOSO	ALIMENTACIÓN	TCC	VIDA ÚTIL (L80)	DRIVER	FUENTE DE LUZ	ÁNGULO DE APERTURA (VxH)	IRC	FP	IP	CORTE DE EMPOTRAMIENTO	PESO (KG)
RE1070BBCB	Aluminio	□	15 W	1200 lm	100-240V ~	3 000 K	30 000 h	Driver electrónico	LED Integrado	24°	90	0.9	40	85 mm	0.25
RE1074BBCB	Aluminio	□	20 W	1600 lm	100-240V ~	3 000 K	30 000 h	Driver electrónico	LED Integrado	24°	90	0.9	40	100 mm	0.5
RE1073BBCB	Aluminio	□	15 W	1200 lm	100-240V ~	3 000 K	30 000 h	Driver electrónico	LED Integrado	24°	90	0.9	40	75 mm x 75 mm	0.25
RE1077BBCB	Aluminio	□	20 W	1600 lm	100-240V ~	3 000 K	30 000 h	Driver electrónico	LED Integrado	24°	90	0.9	40	100 mm x 100 mm	0.5
RE1078BBCB	Aluminio	□	30 W	2400 lm	100-240V ~	3 000 K	30 000 h	Driver electrónico	LED Integrado	24°	90	0.9	40	70 mm x 137 mm	0.7

RE1300BBCB

LED 13 WATTS 1040 LUMENS 3000K 24° ANGLULO APERTURA IP40 BLANCO

NUEVO

RE1300NBCB

LED 13 WATTS 1040 LUMENS 3000K 24° ANGLULO APERTURA IP40 NEGRO



RE1087BBCB

LED 13 WATTS 845 LUMENS 3000K 24° ANGLULO APERTURA IP40 BLANCO

NUEVO

RE1087NBCB

LED 13 WATTS 845 LUMENS 3000K 24° ANGLULO APERTURA IP40 NEGRO



CO1161BBCB

LED 20 WATTS 1300 LUMENS 3000K 24° ANGLULO APERTURA IP40 BLANCO

NUEVO

CO1161NBCB

LED 20 WATTS 1300 LUMENS 3000K 24° ANGLULO APERTURA IP40 NEGRO



RE1310BBCB

LED 20 WATTS 1592 LUMENS 3000K 24° ANGLULO APERTURA IP20 BLANCO

NUEVO

ANTI-GLARE

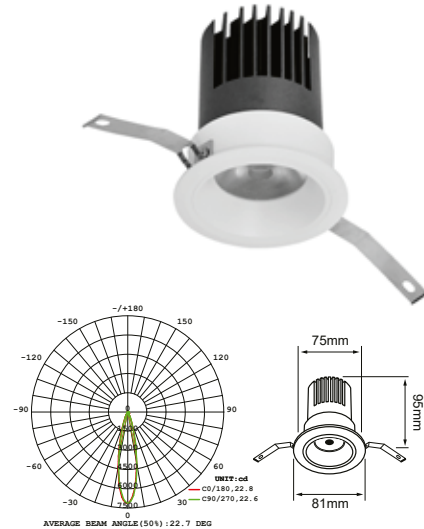

RE1312BBCB

LED 20 WATTS 1592 LUMENS 3000K 24° ANGLULO APERTURA IP20 BLANCO

NUEVO

ANTI-GLARE DIRIGIBLE

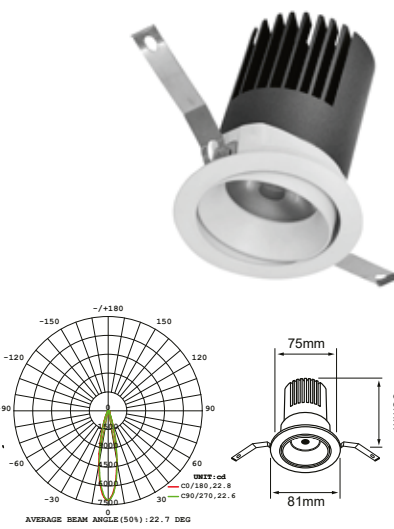

RE1311BBCB

LED 20 WATTS 1580 LUMENS 3000K 24° ANGLULO APERTURA IP20 BLANCO

NUEVO

ANTI-GLARE DIMEABLE 0-10 V

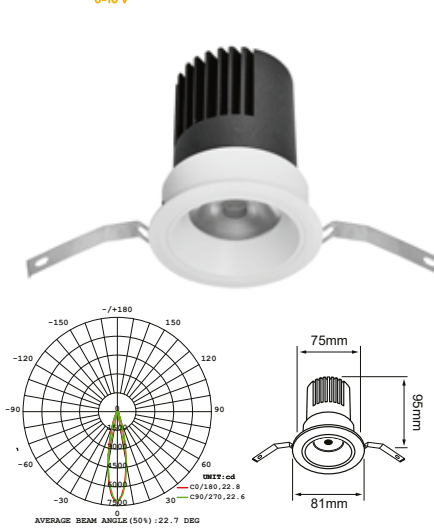

RE1313BBCB

LED 20 WATTS 1580 LUMENS 3000K 24° ANGLULO APERTURA IP20 BLANCO

NUEVO

ANTI-GLARE DIMEABLE 0-10 V DIRIGIBLE

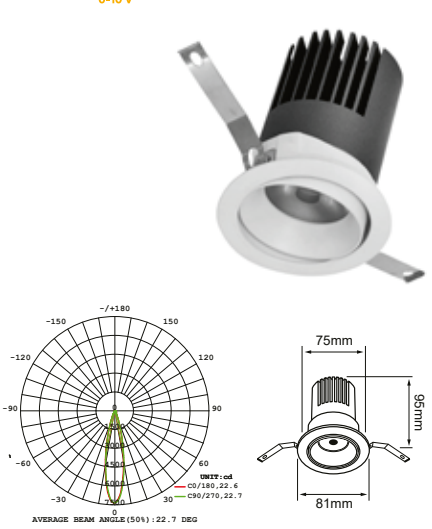

CÓDIGO	MATERIAL DE CUERPO	COLOR	POTENCIA	FLUJO LUMINOSO	ALIMENTACIÓN	TCC	VIDA ÚTIL (L80)	DRIVER	FUENTE DE LUZ	ÁNGULO DE APERTURA (vxH)	IRC	FP	IP	CORTE DE EMPOTRAMIENTO	PESO (KG)
RE1300BBCB	Aluminio	Blanco	13 W	1040 lm	100-240V ~	3 000 K	30 000 h	Driver electrónico	LED Integrado	24°	90	0.5	40	100 mm	0.42
RE1300NBCB	Aluminio	Negro	13 W	1040 lm	100-240V ~	3 000 K	30 000 h	Driver electrónico	LED Integrado	24°	90	0.5	40	100 mm	0.42
RE1087BBCB	Aluminio	Blanco	13 W	845 lm	100-240V ~	3 000 K	30 000 h	Driver electrónico	LED Integrado	24°	90	0.9	40	82 mm	0.4
RE1087NBCB	Aluminio	Negro	13 W	845 lm	100-240V ~	3 000 K	30 000 h	Driver electrónico	LED Integrado	24°	90	0.9	40	82 mm	0.4
CO1161BBCB	Aluminio	Blanco	20 W	1300 lm	100-240V ~	3 000 K	30 000 h	Driver electrónico	LED Integrado	24°	90	0.9	40	80 mm	0.5
CO1161NBCB	Aluminio	Negro	20 W	1300 lm	100-240V ~	3 000 K	30 000 h	Driver electrónico	LED Integrado	24°	90	0.9	40	80 mm	0.5
RE1310BBCB	Aluminio	Blanco	20 W	1592 lm	100-240 V ~	3 000 K	30000 h	Driver LED	LED Integrado	24°	90	0.9	20	75 mm	0.5
RE1312BBCB	Aluminio	Blanco	20 W	1592 lm	100-240 V ~	3 000 K	30000 h	Driver LED	LED Integrado	24°	90	0.9	20	75 mm	0.5
RE1311BBCB	Aluminio	Blanco	20 W	1580 lm	100-240 V ~	3 000 K	30000 h	Driver LED	LED Integrado	24°	90	0.9	20	75 mm	0.5
RE1313BBCB	Aluminio	Blanco	20 W	1580 lm	100-240 V ~	3 000 K	30000 h	Driver LED	LED Integrado	24°	90	0.9	20	75 mm	0.5

CO1110NBCB

LED 3 WATTS 70 LUMENS 3000K 10-36° ANGLULO APERTURA IP30 NEGRO



ZOOMABLE DIRIGIBLE RETRACTIL

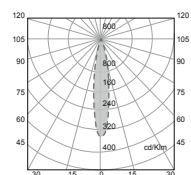

ÁNGULO 10°

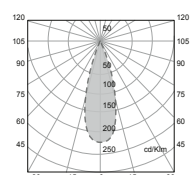

ÁNGULO 36°

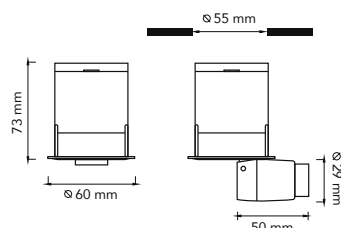

CO1111NBCB

LED 3 WATTS 80 LUMENS 3000K 10-36° ANGLULO APERTURA IP30 NEGRO



ZOOMABLE DIRIGIBLE RETRACTIL



ÁNGULO 10°

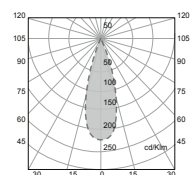

ÁNGULO 36°

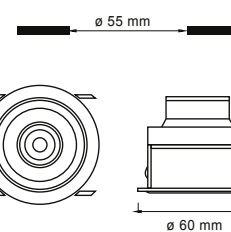

RE1076BBCA

LED 10 WATTS 260 LUMENS 2700K 36° ANGLULO APERTURA IP30 BLANCO



DIRIGIBLE RETRACTIL

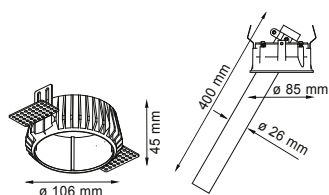
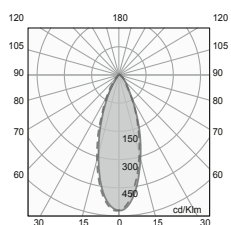

RE1071BBCA

LED 15 WATTS 560 LUMENS 2700K 24° ANGLULO APERTURA IP30 BLANCO



DIRIGIBLE

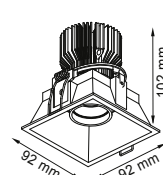
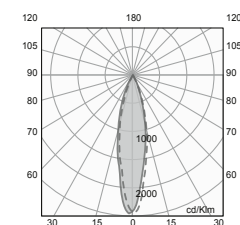
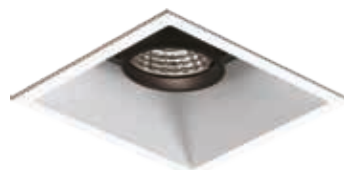

RE1072BBCA

LED 20 WATTS 915 LUMENS 2700K 24° ANGLULO APERTURA IP30 BLANCO



DIRIGIBLE

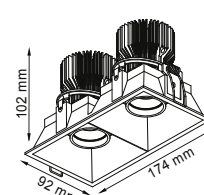
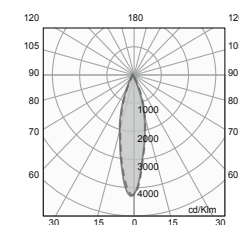

CÓDIGO	MATERIAL DE CUERPO	COLOR	POTENCIA	FLUJO LUMINOSO	ALIMENTACIÓN	TCC	VIDA ÚTIL (L80)	DRIVER	FUENTE DE LUZ	ÁNGULO DE APERTURA (VxH)	IRC	FP	IP	CORTE DE EMPOTRAMIENTO	PESO (KG)
CO1110NBCB	Aluminio	■	3 W	70 lm	127-220 V	3 000 K	30 000 h	Driver electrónico	LED Integrado	10-36°	80	0.9	30	50 mm	0.13
CO1111NBCB	Aluminio	■	3 W	80 lm	127-220 V	3 000 K	30 000 h	Driver electrónico	LED Integrado	10-36°	80	0.9	30	50 mm	0.13
RE1076BBCA	Aluminio	□	10 W	260 lm	127-277 V	2 700 K	50 000 h	Driver electrónico	LED Integrado	36°	90	0.9	30	84 mm	0.64
RE1071BBCA	Aluminio	□	15 W	560 lm	127-277 V	2 700 K	30 000 h	Driver electrónico	LED Integrado	24°	90	0.8	30	84x84 mm	0.51
RE1072BBCA	Aluminio	□	20 W	915 lm	127-277 V	2 700 K	30 000 h	Driver electrónico	LED Integrado	24°	90	0.8	30	164x84 mm	0.76

RE1080BBCD

LED 5 WATTS 530 LUMENS 2700K 38° ANGULO APERTURA IP30 BLANCO

RE1080BBFD

LED 5.5 WATTS 530 LUMENS 5500K 38° ANGULO APERTURA IP30 BLANCO

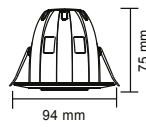
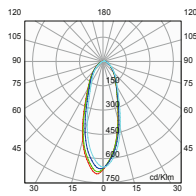

RE1081BBCD

LED 5.5 WATTS 371 LUMENS 2700K 90° ANGULO APERTURA IP30 BLANCO

RE1081BBFB

LED 6.5 WATTS 445 LUMENS 5500K 100° ANGULO APERTURA IP30 BLANCO

RE1081BBFD

LED 5.5 WATTS 400 LUMENS 5500K 100° ANGULO APERTURA IP30 BLANCO

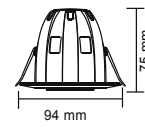
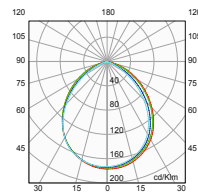

RE1082BBCD

LED 5.5 WATTS 498 LUMENS 2700K 38° ANGULO APERTURA IP30 BLANCO

RE1082BBFB

LED 6.5 WATTS 565 LUMENS 5500K 38° ANGULO APERTURA IP30 BLANCO

RE1082BBFD

LED 5.5 WATTS 530 LUMENS 5500K 38° ANGULO APERTURA IP30 BLANCO

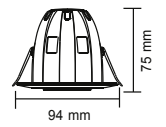
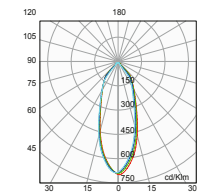

RE1083BBCD

LED 8 WATTS 457 LUMENS 2700K 28° ANGULO APERTURA IP30 BLANCO

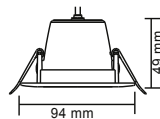
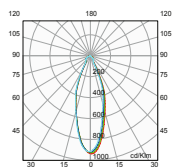

RE1084BBCD

LED 8 WATTS 511 LUMENS 2700K 38° ANGULO APERTURA IP30 BLANCO

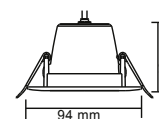
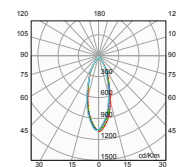

RE1085BBCD

LED 6.5 WATTS 565 LUMENS 2700K 38° ANGULO APERTURA IP30 BLANCO

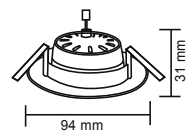
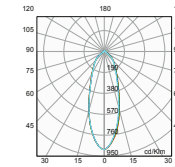

RE1085BBFB

LED 6.5 WATTS 556 LUMENS 5500K 38° ANGULO APERTURA IP30 BLANCO



RE1085BBFD

LED 6.5 WATTS 565 LUMENS 5500K 38° ANGULO APERTURA IP30 BLANCO



CÓDIGO	MATERIAL DE CUERPO	COLOR	POTENCIA	FLUJO LUMINOSO	ALIMENTACIÓN	TCC	VIDA ÚTIL (L80)	DRIVER	FUENTE DE LUZ	ÁNGULO DE APERTURA (VxH)	IRC	FP	IP	CORTE DE EMPOTRAMIENTO	PESO (KG)
RE1080BBCD	ABS	□	5 W	530 lm	127 V	2700 K	25 000 h	Driver electrónico	LED Integrado	38°	80	0.9	30	75 mm	0.27
RE1080BBFD	ABS	□	5.5 W	530 lm	127 V	5500 K	25 000 h	Driver electrónico	LED Integrado	38°	80	0.9	30	75 mm	0.27
RE1081BBCD	Aluminio	□	5.5 W	371 lm	127 V	2700 K	25 000 h	Driver electrónico	LED Integrado	90°	80	0.9	30	75 mm	0.26
RE1081BBFB	ABS	□	6.5 W	445 lm	127-220 V	5500 K	25 000 h	Driver electrónico	LED Integrado	100°	80	0.65	30	75 mm	0.27
RE1081BBFD	Aluminio	□	5.5 W	400 lm	127 V	5500 K	25 000 h	Driver electrónico	LED Integrado	100°	80	0.9	30	75 mm	0.27
RE1082BBCD	ABS	□	5.5 W	498 lm	127 V	2700 K	25 000 h	Driver electrónico	LED Integrado	38°	80	0.95	30	75 mm	0.27
RE1083BBCD	Aluminio	□	8 W	457 lm	127 V	2700 K	25 000 h	Driver electrónico	LED Integrado	28°	80	0.9	30	80 mm	0.28
RE1084BBCD	Aluminio	□	8 W	511 lm	127 V	2700 K	25 000 h	Driver electrónico	LED Integrado	38°	80	0.9	30	75 mm	0.25
RE1085BBCD	Aluminio	□	6.5 W	565 lm	127 V	2700 K	25 000 h	Driver electrónico	LED Integrado	38°	80	0.65	30	75 mm	0.22
RE1085BBFB	Aluminio	□	6.5 W	556 lm	127-220 V	5500 K	25 000 h	Driver electrónico	LED Integrado	38°	80	0.65	30	75 mm	0.22
RE1085BBFD	Aluminio	□	6.5 W	565 lm	127 V	5500 K	25 000 h	Driver electrónico	LED Integrado	38°	80	0.65	30	75 mm	0.22

CO1074BBCB

LED 1x6 WATTS 423 LUMENS 3000K 36° ANGLULO APERTURA IP30 BLANCO

CO1074BBFA

LED 1x6 WATTS 423 LUMENS 6500K 36° ANGLULO APERTURA IP30 BLANCO



CO1060BBCB

LED 1x6 WATTS 423 LUMENS 3000K 36° ANGLULO APERTURA IP30 BLANCO

CO1060BBFA

LED 1x6 WATTS 423 LUMENS 6500K 36° ANGLULO APERTURA IP30 BLANCO



CO1066BBFA

LED 1x6 WATTS 423 LUMENS 6500K 36° ANGLULO APERTURA IP30 BLANCO

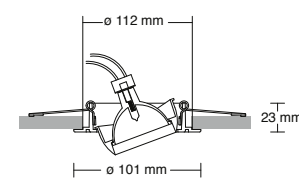
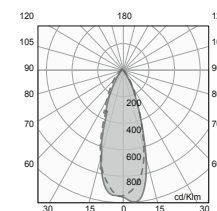
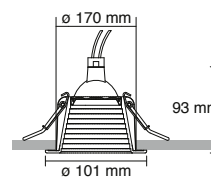
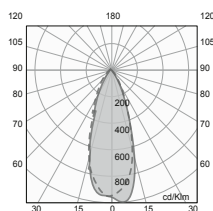
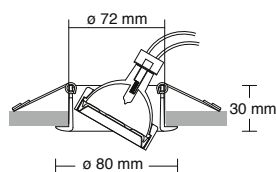
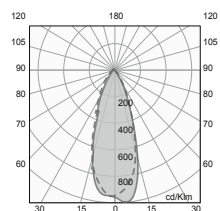

CÓDIGO	MATERIAL DE CUERPO	COLOR	POTENCIA	FLUJO LUMINOSO	ALIMENTACIÓN	TCC	VIDA ÚTIL (L80)	FUENTE DE LUZ	ÁNGULO DE APERTURA (VxH)	IRC	FP	IP	CORTE DE EMPOTRAMIENTO	PESO (KG)
CO1074BBCB	Aluminio	□	1X6 W	423 lm	127-240 V	3 000 K	25 000 h	MR16	36°	80	0.5	30	80 mm	0.2
CO1074BBFA	Aluminio	□	1X6 W	423 lm	127-277 V	6 500 K	25 000 h	MR16	36°	80	0.8	30	80 mm	0.2
CO1060BBCB	Aluminio	□	1X6 W	423 lm	127-240 V	3 000 K	25 000 h	MR16	36°	80	0.5	30	98 mm	0.24
CO1060BBFA	Aluminio	□	1X6 W	423 lm	127-277 V	6 500 K	25 000 h	MR16	36°	80	0.5	30	98 mm	0.24
CO1066BBFA	Aluminio	□	1X6 W	423 lm	127-277 V	6 500 K	25 000 h	MR16	36°	80	0.8	30	88 mm	0.21

CO1082BBCA

LED 20 WATTS 1056 LUMENS 3000K 30° ANGULO APERTURA IP20 BLANCO

NUEVO

CO1082NBCA

LED 20 WATTS 1056 LUMENS 3000K 30° ANGULO APERTURA IP20 NEGRO

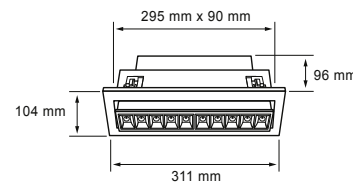
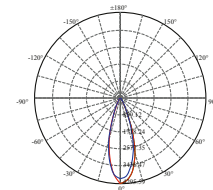

CO1083BBCA

LED 30 WATTS 1595 LUMENS 3000K 30° ANGULO APERTURA IP20 BLANCO

NUEVO

CO1083NBCA

LED 30 WATTS 1595 LUMENS 3000K 30° ANGULO APERTURA IP20 NEGRO

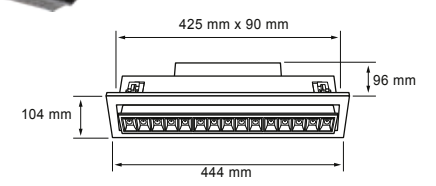
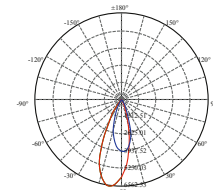

CO1084BBCA

LED 40 WATTS 1925 LUMENS 3000K 30° ANGULO APERTURA IP20 BLANCO

NUEVO

CO1084NBCA

LED 40 WATTS 1925 LUMENS 3000K 30° ANGULO APERTURA IP20 NEGRO

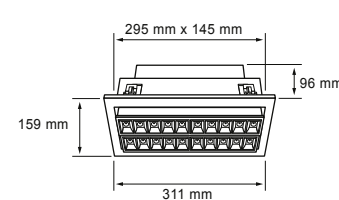
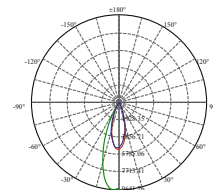

CO1085BBCA

LED 60 WATTS 3355 LUMENS 3000K 30° ANGULO APERTURA IP20 BLANCO

NUEVO

CO1085NBCA

LED 60 WATTS 3355 LUMENS 3000K 30° ANGULO APERTURA IP20 NEGRO

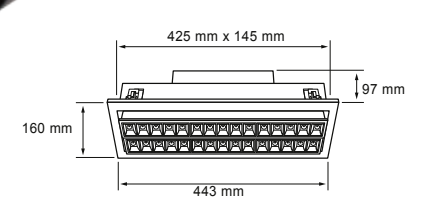
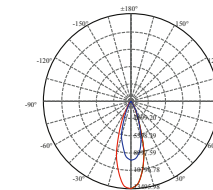

CÓDIGO	MATERIAL DE CUERPO	COLOR	POTENCIA	FLUJO LUMINOSO	ALIMENTACIÓN	TCC	VIDA ÚTIL (L80)	DRIVER	FUENTE DE LUZ	ÁNGULO DE APERTURA (VxH)	IRC	FP	IP	CORTE DE EMPOTRAMIENTO	PESO (KG)
CO1082BBCA	Aluminio	Blanco	20 W	1056 lm	100-277V ~	3 000 K	30 000 h	Driver electrónico	LED Integrado	30°	90	0.9	20	293 mm x 90 mm	1.18
CO1082NBCA	Aluminio	Negro	20 W	1056 lm	100-277V ~	3 000 K	30 000 h	Driver electrónico	LED Integrado	30°	90	0.9	20	293 mm x 90 mm	1.18
CO1083BBCA	Aluminio	Blanco	30 W	1595 lm	100-277V ~	3 000 K	30 000 h	Driver electrónico	LED Integrado	30°	90	0.9	20	425 mm x 90 mm	1.7
CO1083NBCA	Aluminio	Negro	30 W	1595 lm	100-277V ~	3 000 K	30 000 h	Driver electrónico	LED Integrado	30°	90	0.9	20	425 mm x 90 mm	1.7
CO1084BBCA	Aluminio	Blanco	40 W	1925 lm	100-277V ~	3 000 K	30 000 h	Driver electrónico	LED Integrado	30°	90	0.9	20	293 mm x 153 mm	1.9
CO1084NBCA	Aluminio	Negro	40 W	1925 lm	100-277V ~	3 000 K	30 000 h	Driver electrónico	LED Integrado	30°	90	0.9	20	293 mm x 153 mm	1.9
CO1085BBCA	Aluminio	Blanco	60 W	3355 lm	100-277V ~	3 000 K	30 000 h	Driver electrónico	LED Integrado	30°	90	0.9	20	425 mm x 153 mm	2.7
CO1085NBCA	Aluminio	Negro	60 W	3355 lm	100-277V ~	3 000 K	30 000 h	Driver electrónico	LED Integrado	30°	90	0.9	20	425 mm x 153 mm	2.7

CO1260BBCA

LED 4 WATTS 231 LUMENS 3000K 30° ANGULO APERTURA IP20 E.N.

NUEVO



ANTI-GLARE

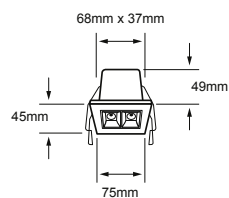
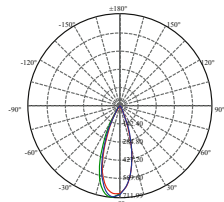
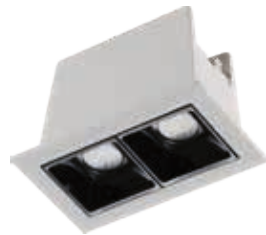

CO1261BBCA

LED 10 WATTS 505 LUMENS 3000K 30° ANGULO APERTURA IP20 E.N.

NUEVO



ANTI-GLARE

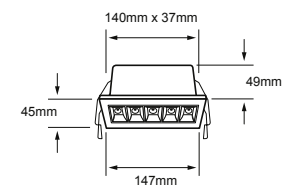
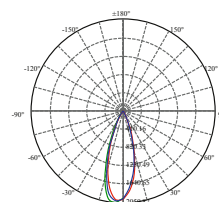

CO1262BBCA

LED 20 WATTS 1010 LUMENS 3000K 30° ANGULO APERTURA IP20 E.N.

NUEVO



ANTI-GLARE

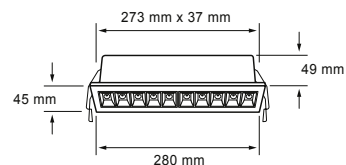
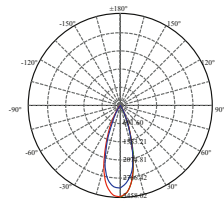

CO1263BBCA

LED 30 WATTS 1570 LUMENS 3000K 30° ANGULO APERTURA IP20 E.N.

NUEVO



ANTI-GLARE

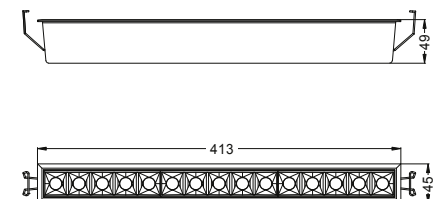
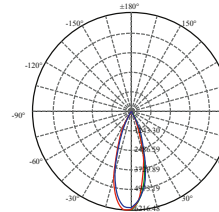

CÓDIGO	MATERIAL DE CUERPO	COLOR	POTENCIA	FLUJO LUMINOSO	ALIMENTACIÓN	TCC	VIDA ÚTIL(L80)	DRIVER	FUENTE DE LUZ	ÁNGULO DE APERTURA (VxH)	IRC	FP	IP	CORTE DE EMPOTRAMIENTO	PESO (KG)
CO1260BBCA	Aluminio	■	4 W	231 lm	100-277V ~	3 000 K	50 000 h	Driver electrónico	LED Integrado	30°	90	0.9	20	68 mm x 37 mm	0.2
CO1261BBCA	Aluminio	■	10 W	505 lm	100-277V ~	3 000 K	50 000 h	Driver electrónico	LED Integrado	30°	90	0.9	20	140 mm x 37 mm	0.33
CO1262BBCA	Aluminio	■	20 W	1010 lm	100-277V ~	3 000 K	50 000 h	Driver electrónico	LED Integrado	30°	90	0.9	20	273 mm x 37 mm	0.555
CO1263BBCA	Aluminio	■	30 W	1570 lm	100-277V ~	3 000 K	50 000 h	Driver electrónico	LED Integrado	30°	90	0.9	20	405 mm x 37 mm	0.8

CO1264NBCA

LED 4 WATTS 231 LUMENS 3000K 30° ANGULO APERTURA IP20 NEGRO

NUEVO

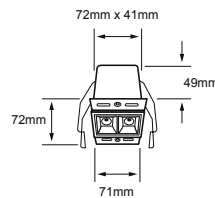
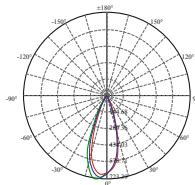

CO1265NBCA

LED 10 WATTS 505 LUMENS 3000K 30° ANGULO APERTURA IP20 NEGRO

NUEVO

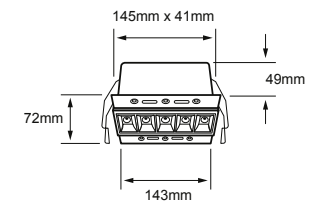
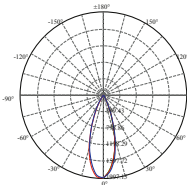

CO1266NBCA

LED 20 WATTS 1010 LUMENS 3000K 30° ANGULO APERTURA IP20 NEGRO

NUEVO

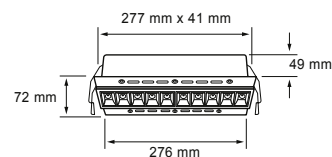
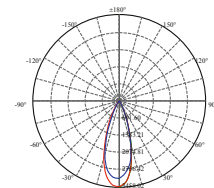

CO1267NBCA

LED 30 WATTS 1570 LUMENS 3000K 30° ANGULO APERTURA IP20 NEGRO

NUEVO

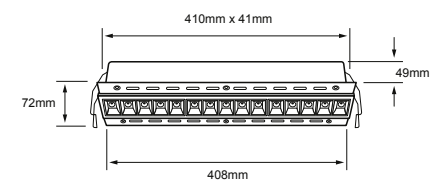
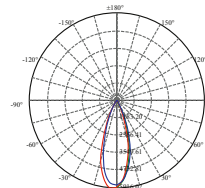

CÓDIGO	MATERIAL DE CUERPO	COLOR	POTENCIA	FLUJO LUMINOSO	ALIMENTACIÓN	TCC	VIDA ÚTIL (L80)	DRIVER	FUENTE DE LUZ	ÁNGULO DE APERTURA (VxH)	IRC	FP	IP	CORTE DE EMPOTRAMIENTO	PESO (KG)
CO1264NBCA	Aluminio	■	4 W	231 lm	100-277V ~	3 000 K	50 000 h	Driver electrónico	LED Integrado	30°	90	0.9	20	72 mm x 41 mm	0.215
CO1265NBCA	Aluminio	■	10 W	505 lm	100-277V ~	3 000 K	50 000 h	Driver electrónico	LED Integrado	30°	90	0.9	20	145 mm x 41 mm	0.378
CO1266NBCA	Aluminio	■	20 W	1010 lm	100-277V ~	3 000 K	50 000 h	Driver electrónico	LED Integrado	30°	90	0.9	20	277 mm x 41 mm	0.665
CO1267NBCA	Aluminio	■	30 W	1570 lm	100-277V ~	3 000 K	50 000 h	Driver electrónico	LED Integrado	30°	90	0.9	20	410 mm x 41 mm	0.925

CO1095BBCA

LED 12 WATTS 317 LUMENS 3000K 40° ANGLULO APERTURA IP30 E.N.



ANTI-GLARE

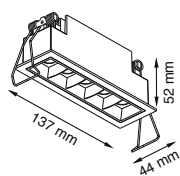
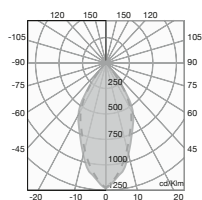

CO1094BBCA

LED 23 WATTS 1706 LUMENS 3000K 42° ANGLULO APERTURA IP30 E.N.



ANTI-GLARE

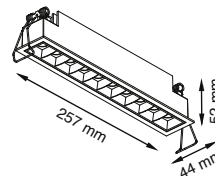
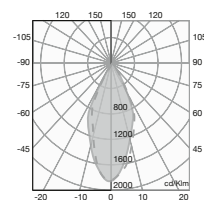

CO1096BBCA

LED 24 WATTS 1386 LUMENS 3000K 30° ANGLULO APERTURA IP30 E.N.



ANTI-GLARE

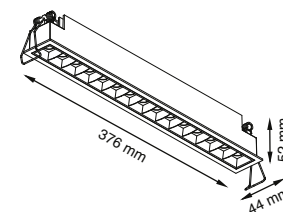
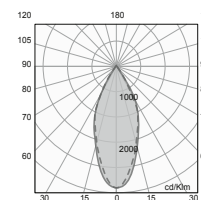

CO1098BBCA

LED 12 WATTS 844 LUMENS 3000K 42° ANGLULO APERTURA IP30 E.N.



ANTI-GLARE



DIRIGIBLE

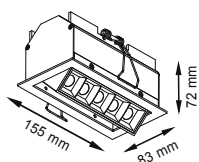
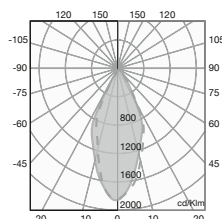

CO1097BBCA

LED 23 WATTS 1450 LUMENS 3000K 30° ANGLULO APERTURA IP30 E.N.



ANTI-GLARE



DIRIGIBLE

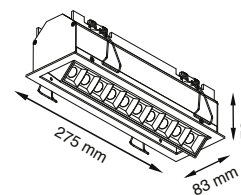
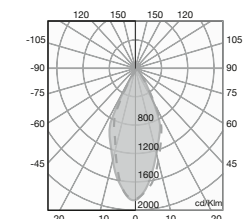

CO1099BBCA

LED 34 WATTS 2517 LUMENS 3000K 42° ANGLULO APERTURA IP30 E.N.



ANTI-GLARE



DIRIGIBLE

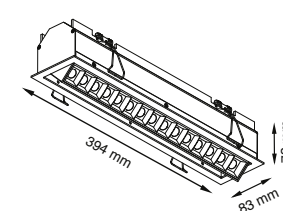
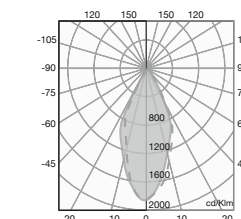

CÓDIGO	MATERIAL DE CUERPO	COLOR	POTENCIA	FLUJO LUMINOSO	ALIMENTACIÓN	TCC	VIDA ÚTIL (L80)	DRIVER	FUENTE DE LUZ	ÁNGULO DE APERTURA (VxH)	IRC	FP	IP	CORTE DE EMPOTRAMIENTO	PESO (KG)
CO1095BBCA	Aluminio	■	12 W	617 lm	127-277 V	3 000 K	25 000 h	Driver electrónico	LED Integrado	40°	92	0.7	30	128X35 mm	0.32
CO1094BBCA	Aluminio	■	23 W	1706 lm	127-277 V	3 000 K	25 000 h	Driver electrónico	LED Integrado	42°	90	0.95	30	1210X47 mm	0.6
CO1096BBCA	Aluminio	■	24 W	1386 lm	127-277 V	3 000 K	25 000 h	Driver electrónico	LED Integrado	30°	90	0.85	30	367X35 mm	0.8
CO1098BBCA	Aluminio	■	12 W	844 lm	127-277 V	3 000 K	25 000 h	Driver electrónico	LED Integrado	42°	90	0.7	30	143X72 mm	0.37
CO1097BBCA	Aluminio	■	23 W	1450 lm	127-277 V	3 000 K	25 000 h	Driver electrónico	LED Integrado	30°	90	0.95	30	263X74 mm	1.5
CO1099BBCA	Aluminio	■	34 W	2517 lm	127-277 V	3 000 K	25 000 h	Driver electrónico	LED Integrado	42°	90	0.5	30	394X76 mm	0.7

CO1101BBCB

LED 3 WATTS 85 LUMENS 3000K 45° ANGULO APERTURA IP30 BN

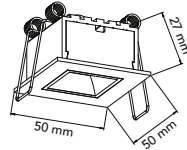
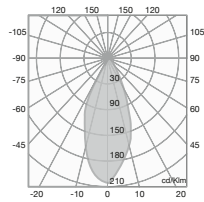

CO1102BBCB

LED 5 WATTS 206 LUMENS 3000K 45° ANGULO APERTURA IP30 BN

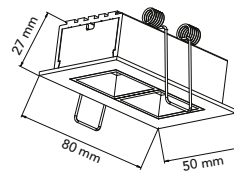
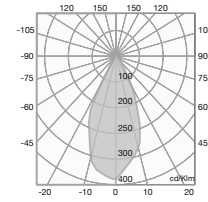

CO1103BBCB

LED 7 WATTS 321 LUMENS 3000K 45° ANGULO APERTURA IP30 BN

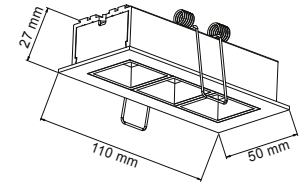
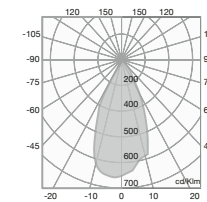

CO1104BBCB

LED 12 WATTS 407 LUMENS 3000K 45° ANGULO APERTURA IP30 BN

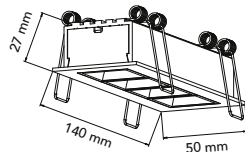
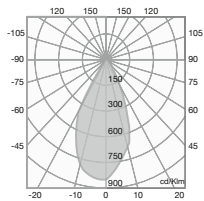

CO1105BBCB

LED 14 WATTS 554 LUMENS 3000K 45° ANGULO APERTURA IP30 BN

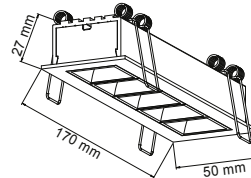
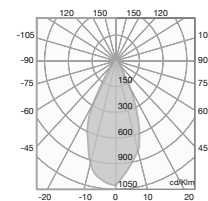

CO1106BBCB

LED 18 WATTS 616 LUMENS 3000K 45° ANGULO APERTURA IP30 BN

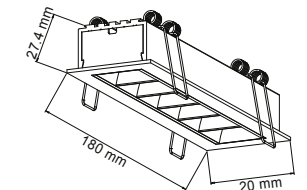
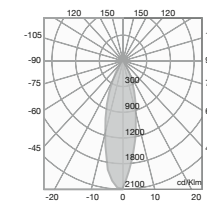

CÓDIGO	MATERIAL DE CUERPO	COLOR	POTENCIA	FLUJO LUMINOSO	ALIMENTACIÓN	TCC	VIDA ÚTIL (L80)	DRIVER	FUENTE DE LUZ	ÁNGULO DE APERTURA (VxH)	IRC	FP	IP	CORTE DE EMPOTRAMIENTO	PESO (KG)
CO1101BBCB	Aluminio	■	3 W	85 lm	127-220 V	3 000 K	25 000 h	Driver electrónico	LED Integrado	45°	80	0.5	30	45X45 mm	0.075
CO1102BBCB	Aluminio	■	5 W	206 lm	127-220 V	3 000 K	25 000 h	Driver electrónico	LED Integrado	45°	80	0.5	30	75X45 mm	0.11
CO1103BBCB	Aluminio	■	7 W	321 lm	127-220 V	3 000 K	25 000 h	Driver electrónico	LED Integrado	45°	80	0.5	30	103X45 mm	0.14
CO1104BBCB	Aluminio	■	12 W	407 lm	127-220 V	3 000 K	25 000 h	Driver electrónico	LED Integrado	45°	80	0.5	30	133X45 mm	0.18
CO1105BBCB	Aluminio	■	14 W	554 lm	127-220 V	3 000 K	25 000 h	Driver electrónico	LED Integrado	45°	80	0.9	30	163X45 mm	0.21
CO1106BBCB	Aluminio	■	18 W	616 lm	127-220 V	3 000 K	25 000 h	Driver electrónico	LED Integrado	45°	80	0.9	30	173X45 mm	0.215

CO1270BBCA

LED 15 WATTS 1191 LUMENS 3000K 30° ANGLULO APERTURA IP20 BLANCO

NUEVO

CO1270NBCA

LED 15 WATTS 1191 LUMENS 3000K 30° ANGLULO APERTURA IP20 NEGRO



ANTI-GLARE

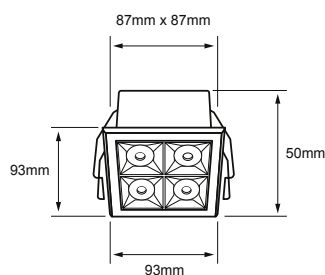
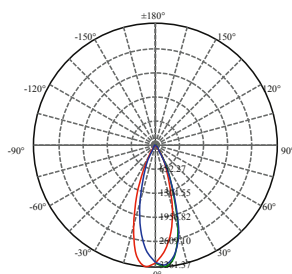

CO1271BBCA

LED 36 WATTS 2800 LUMENS 3000K 30° ANGLULO APERTURA IP20 BLANCO

NUEVO

CO1271NBCA

LED 36 WATTS 2800 LUMENS 3000K 30° ANGLULO APERTURA IP20 NEGRO



ANTI-GLARE

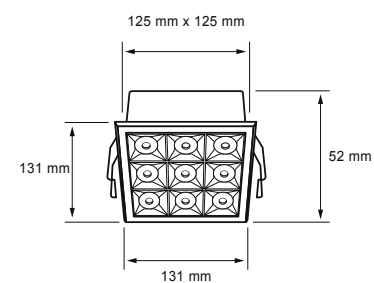
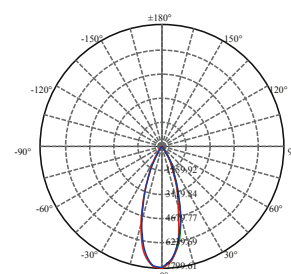

CÓDIGO	MATERIAL DE CUERPO	COLOR	POTENCIA	FLUJO LUMINOSO	ALIMENTACIÓN	TCC	VIDA ÚTIL(L80)	DRIVER	FUENTE DE LUZ	ÁNGULO DE APERTURA (VxH)	IRC	FP	IP	CORTE DE EMPOTRAMIENTO	PESO (KG)
CO1270BBCA	Aluminio	□	15 W	1191 lm	100-277V ~	3 000 K	50 000 h	Driver electrónico	LED Integrado	30°	90	0.9	20	87 mm x 87 mm	0.358
CO1270NBCA	Aluminio	■	15 W	1191 lm	100-277V ~	3 000 K	50 000 h	Driver electrónico	LED Integrado	30°	90	0.9	20	87 mm x 87 mm	0.358
CO1271BBCA	Aluminio	□	36 W	2800 lm	100-277V ~	3 000 K	50 000 h	Driver electrónico	LED Integrado	30°	90	0.9	20	125 mm x 125 mm	0.76
CO1271NBCA	Aluminio	■	36 W	2800 lm	100-277V ~	3 000 K	50 000 h	Driver electrónico	LED Integrado	30°	90	0.9	20	125 mm x 125 mm	0.76

CO1086BBCA

LED 10 WATTS 1000 LUMENS 3000K IP20 B/N NUEVO

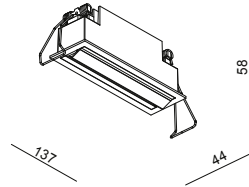
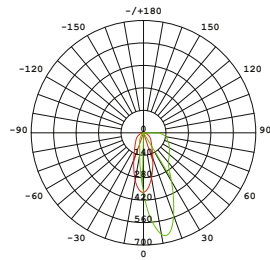

CO1087BBCA

LED 20 WATTS 2150 LUMENS 3000K IP20 B/N NUEVO

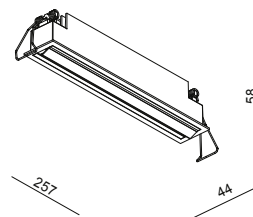
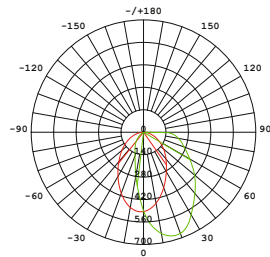

CO1088BBCA

LED 30 WATTS 3100 LUMENS 3000K IP20 B/N NUEVO

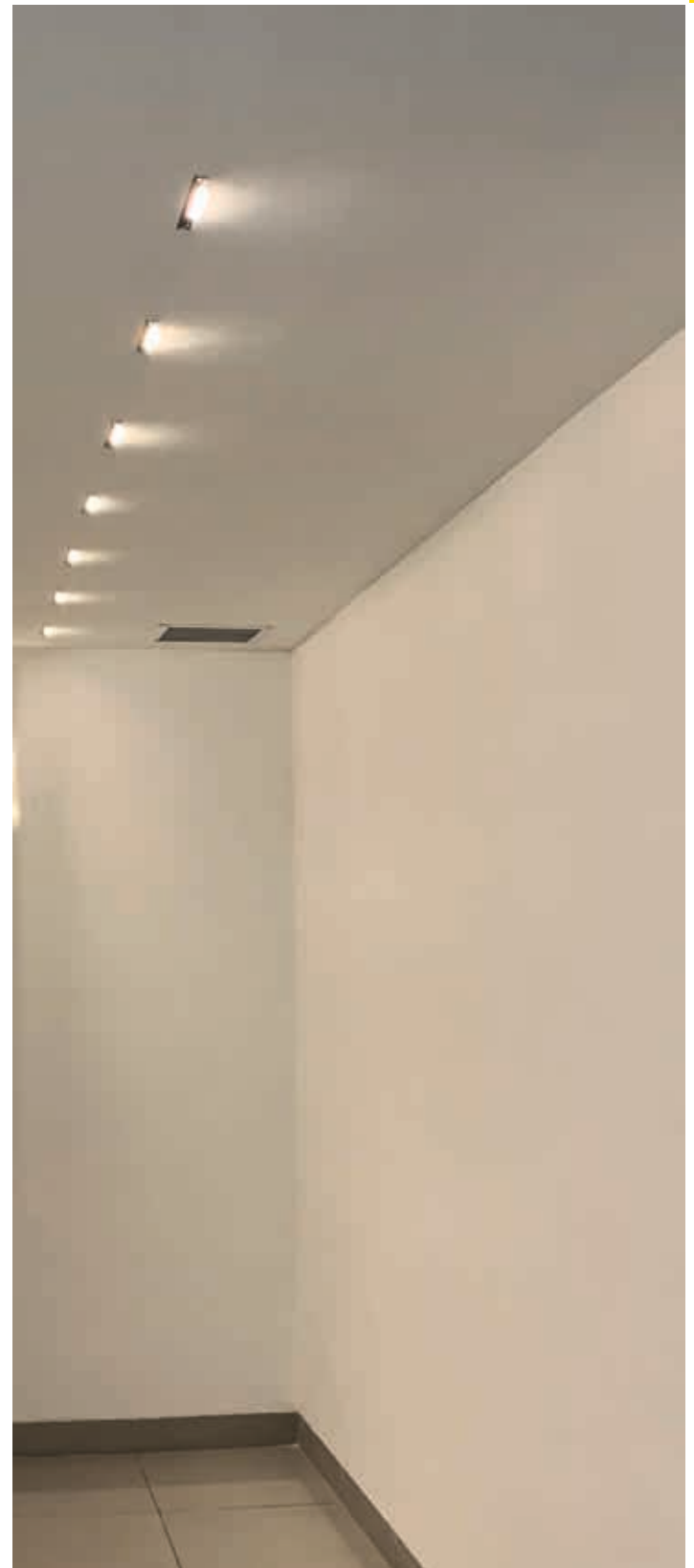
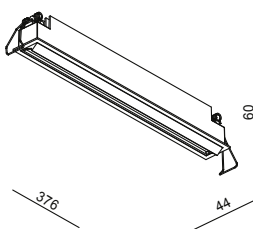
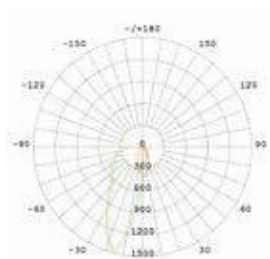

CÓDIGO	MATERIAL DE CUERPO	COLOR	POTENCIA	FLUJO LUMINOSO	ALIMENTACIÓN	TCC	VIDA ÚTIL (L80)	DRIVER	FUENTE DE LUZ	ÁNGULO DE APERTURA (vxH)	IRC	FP	IP	CORTE DE EMPOTRAMIENTO	IK	PESO (KG)
CO1086BBCA	Aluminio/PC	Blanco/Negro	10 W	1000 lm	100-277 V ~	3 000 K	50000 h	Driver LED	LED Integrado	WW	90	0.9	20	130 X 37 mm	-	0.45
CO1087BBCA	Aluminio/PC	Blanco/Negro	20 W	2150 lm	100-277 V ~	3 000 K	50000 h	Driver LED	LED Integrado	WW	90	0.6	20	250 X 37 mm	-	0.87
CO1088BBCA	Aluminio/PC	Blanco/Negro	30 W	3100 lm	100-277 V ~	3 000 K	50000 h	Driver LED	LED Integrado	WW	90	0.6	20	369 X 37 mm	-	1.22

CO4023BBNA

LED 15 WATTS 1106 LUMENS 4000K 32° ANGULO APERTURA IP30 BLANCO

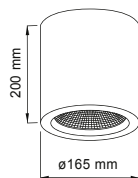
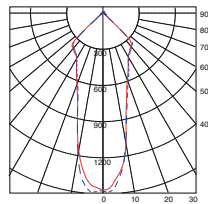

CO4025BBNA

LED 13 WATTS 812 LUMENS 4000K 36° ANGULO APERTURA IP30 BLANCO

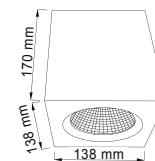
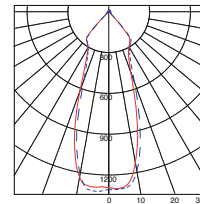

CO4083NBCA

LED 15 WATTS 1155 LUMENS 3000K 30° ANGULO APERTURA IP20 NEGRO

NUEVO

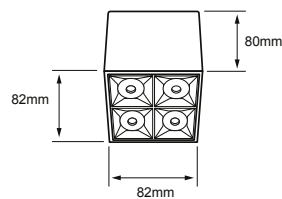
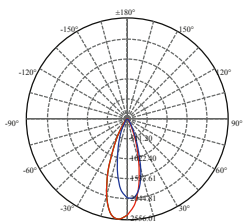

CO4084NBCA

LED 36 WATTS 2860 LUMENS 3000K 30° ANGULO APERTURA IP20 NEGRO

NUEVO

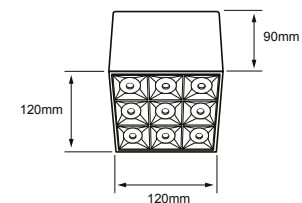
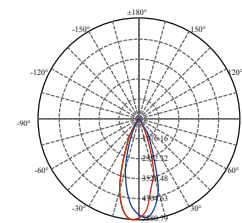

CÓDIGO	MATERIAL DE CUERPO	COLOR	POTENCIA	FLUJO LUMINOSO	ALIMENTACIÓN	TCC	VIDA ÚTIL(L80)	DRIVER	FUENTE DE LUZ	ÁNGULO DE APERTURA (vxH)	IRC	FP	IP	IK	PESO (KG)
CO4023BBNA	Aluminio	□	15 W	1106 lm	127-277 V	□ 4 000 K	25 000 h	Driver electrónico	LED Integrado	32°	80	0.85	30	-	1.66
CO4025BBNA	Aluminio	□	13 W	812 lm	127-277 V	□ 4 000 K	25 000 h	Driver electrónico	LED Integrado	36°	80	0.9	30	-	0.15
CO4083NBCA	Aluminio	■	15 W	1155 lm	100-277V ~	■ 3 000 K	50 000 h	Driver electrónico	LED Integrado	30°	90	0.9	20	0.408	0.82
CO4084NBCA	Aluminio	■	36 W	2860 lm	100-277V ~	■ 3 000 K	50 000 h	Driver electrónico	LED Integrado	30°	90	0.9	20	0.98	0.82

RE4036BBCB

LED 12 WATTS 1028 LUMENS 3000K 34° ANGLULO APERTURA IP20 BLANCO

NUEVO

RE4036NBCB

LED 12 WATTS 1028 LUMENS 3000K 34° ANGLULO APERTURA IP20 NEGRO



ANTI-GLARE

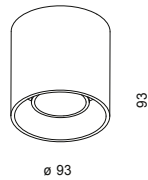
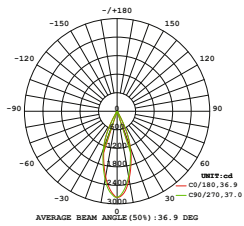

RE4033BBCB

LED 11.5 WATTS 1132 LUMENS 3000K 37° ANGLULO APERTURA IP20 BLANCO

NUEVO

RE4033NBCB

LED 11.5 WATTS 1132 LUMENS 3000K 37° ANGLULO APERTURA IP20 NEGRO



DIRIGIBLE

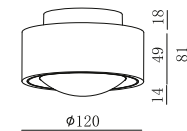
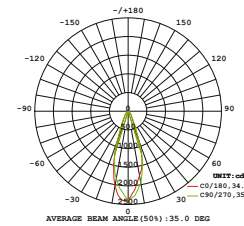

RE4034BBCB

LED 12 WATTS 547 LUMENS 3000K 34° ANGLULO APERTURA IP44 BLANCO

NUEVO

RE4034NBCB

LED 12 WATTS 547 LUMENS 3000K 34° ANGLULO APERTURA IP44 NEGRO



ANTI-GLARE

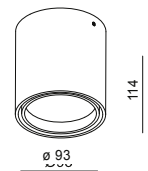
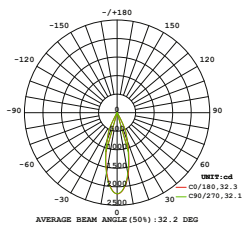

RE4035BBCB

LED 12 WATTS 800 LUMENS 3000K 34° ANGLULO APERTURA IP44 BLANCO

NUEVO

RE4035NBCB

LED 12 WATTS 800 LUMENS 3000K 34° ANGLULO APERTURA IP44 NEGRO



ANTI-GLARE

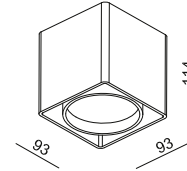
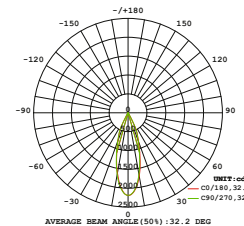
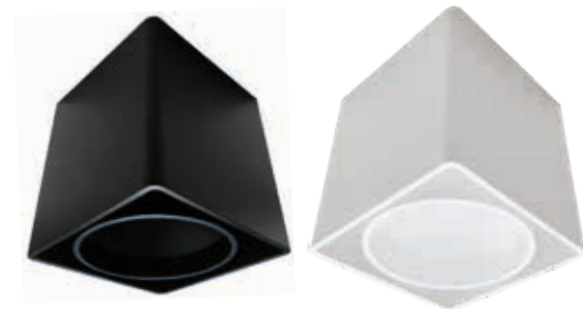

CÓDIGO	MATERIAL DE CUERPO	COLOR	POTENCIA	FLUJO LUMINOSO	ALIMENTACIÓN	TCC	VIDA ÚTIL (L80)	DRIVER	FUENTE DE LUZ	ÁNGULO DE APERTURA (VxH)	IRC	FP	IP	PESO (KG)
RE4036BBCB	Aluminio	Blanco	12 W	1028 lm	100-240 V ~	3 000 K	30000 h	Driver LED	LED Integrado	34°	90	0.9	20	0.62
RE4036NBCB	Aluminio	Negro	12 W	1028 lm	100-240 V ~	3 000 K	30000 h	Driver LED	LED Integrado	34°	90	0.9	20	0.62
RE4033BBCB	Aluminio	Blanco	11.5 W	1132 lm	100-240 V ~	3 000 K	30000 h	Driver electrónico	LED Integrado	37°	90	0.9	20	0.82
RE4033NBCB	Aluminio	Negro	11.5 W	1132 lm	100-240 V ~	3 000 K	30000 h	Driver electrónico	LED Integrado	37°	90	0.9	20	0.82
RE4034BBCB	Aluminio	Blanco	12 W	547 lm	100-240 V ~	3 000 K	30000 h	Driver electrónico	LED Integrado	34°	90	0.9	44	0.82
RE4034NBCB	Aluminio	Negro	12 W	547 lm	100-240 V ~	3 000 K	30000 h	Driver electrónico	LED Integrado	34°	90	0.9	44	0.82
RE4035BBCB	Aluminio	Blanco	12 W	800 lm	100-240 V ~	3 000 K	30000 h	Driver electrónico	LED Integrado	34°	90	0.9	44	0.82
RE4035NBCB	Aluminio	Negro	12 W	800 lm	100-240 V ~	3 000 K	30000 h	Driver electrónico	LED Integrado	34°	90	0.9	44	0.82

CO4080BBCA

LED 10 WATTS 670 LUMENS 3000K 30° ANGULO APERTURA IP20 BLANCO

NUEVO

CO4080NBCA

LED 10 WATTS 670 LUMENS 3000K 30° ANGULO APERTURA IP20 NEGRO

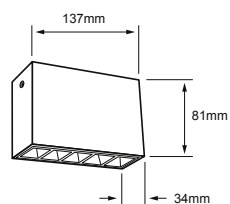
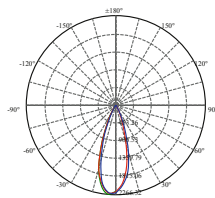

CO4081BBCA

LED 20 WATTS 1350 LUMENS 3000K 30° ANGULO APERTURA IP20 BLANCO

NUEVO

CO4081NBCA

LED 20 WATTS 1350 LUMENS 3000K 30° ANGULO APERTURA IP20 NEGRO

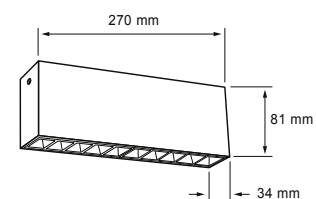
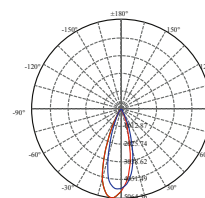
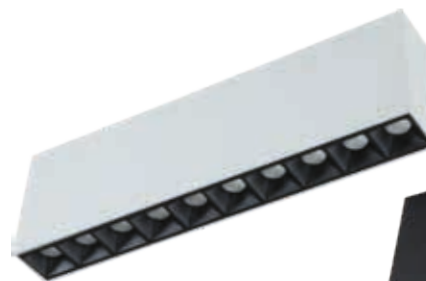

CO4082BBCA

LED 30 WATTS 1969 LUMENS 3000K 30° ANGULO APERTURA IP20 BLANCO

NUEVO

CO4082NBCA

LED 30 WATTS 1969 LUMENS 3000K 30° ANGULO APERTURA IP20 NEGRO

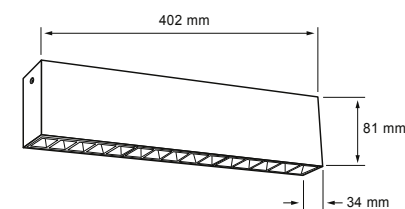
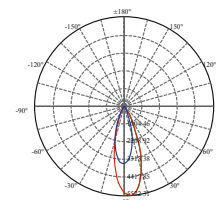

CÓDIGO	MATERIAL DE CUERPO	COLOR	POTENCIA	FLUJO LUMINOSO	ALIMENTACIÓN	TCC	VIDA ÚTIL (L80)	DRIVER	FUENTE DE LUZ	ÁNGULO DE APERTURA (VxH)	IRC	FP	IP	PESO (KG)
CO4080BBCA	Aluminio	□	10 W	670 lm	100-277V ~	3 000 K	50 000 h	Driver electrónico	LED Integrado	30°	90	0.9	20	0.36
CO4080NBCA	Aluminio	■	10 W	670 lm	100-277V ~	3 000 K	50 000 h	Driver electrónico	LED Integrado	30°	90	0.9	20	0.36
CO4081BBCA	Aluminio	□	20 W	1350 lm	100-277V ~	3 000 K	50 000 h	Driver electrónico	LED Integrado	30°	90	0.9	20	0.74
CO4081NBCA	Aluminio	■	20 W	1350 lm	100-277V ~	3 000 K	50 000 h	Driver electrónico	LED Integrado	30°	90	0.9	20	0.74
CO4082BBCA	Aluminio	□	30 W	1969 lm	100-277V ~	3 000 K	50 000 h	Driver electrónico	LED Integrado	30°	90	0.9	20	1.09
CO4082NBCA	Aluminio	■	30 W	1969 lm	100-277V ~	3 000 K	50 000 h	Driver electrónico	LED Integrado	30°	90	0.9	20	1.09

CO6620NBCA

LED 3 WATTS 300 LUMENS 3000K 4° ANGULO APERTURA IP30 NEGRO

NUEVO

CO6620NBFA

LED 3 WATTS 300 LUMENS 5000K 4° ANGULO APERTURA IP30 NEGRO

CO6620NBNA

LED 3 WATTS 300 LUMENS 4000K 4° ANGULO APERTURA IP30 NEGRO

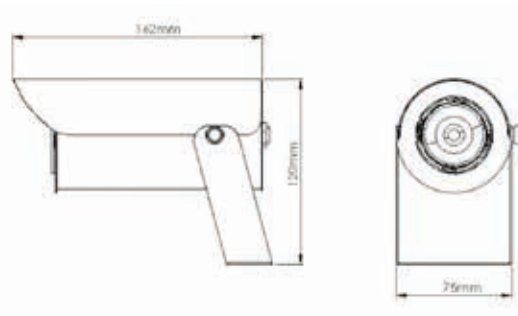
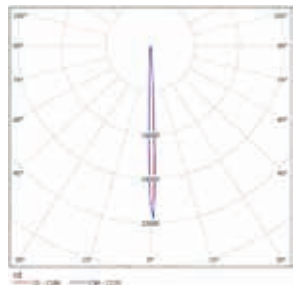

CO1230BBCA

LED 37 WATTS 2400 LUMENS 3000K 10° ANGULO APERTURA IP30 BLANCO

CO1230NBCA

LED 37 WATTS 2400 LUMENS 3000K 10° ANGULO APERTURA IP30 NEGRO

CO1231BBCA

LED 37 WATTS 2400 LUMENS 3000K 24° ANGULO APERTURA IP30 BLANCO

CO1231NBCA

LED 37 WATTS 2400 LUMENS 3000K 24° ANGULO APERTURA IP30 NEGRO

CO1232BBCA

LED 37 WATTS 2400 LUMENS 3000K 45° ANGULO APERTURA IP30 BLANCO

CO1232NBCA

LED 37 WATTS 2400 LUMENS 3000K 45° ANGULO APERTURA IP30 NEGRO

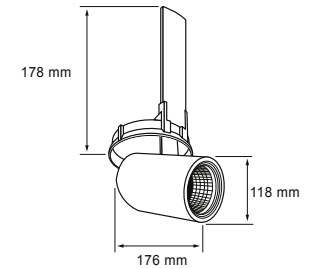
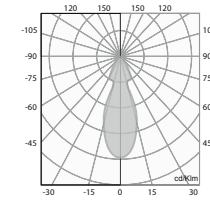

BENEFICIOS

- Amplia direccionalidad
- Tres ángulos de apertura
- Placas doble vista

Luminarios CO1230 requieren accesorios para instalación y funcionamiento:

ACCESORIO

AC1074B

AC1074N

Cylinder placa sencilla pag. 219

ACCESORIO

AC1075B

AC1075N

Cylinder placa doble pag. 219

ACCESORIO

AC1077B

Cylinder placa triple pag. 219

ACCESORIO

AC1072B

AC1072N

Cylinder arillo sencillo pag. 219

CÓDIGO	MATERIAL DE CUERPO	COLOR	POTENCIA	FLUJO LUMINOSO	ALIMENTACIÓN	TCC	VIDA ÚTIL (L80)	DRIVER	FUENTE DE LUZ	ÁNGULO DE APERTURA (VxH)	IRC	FP	IP	CORTE DE EMPOTRAMIENTO	PESO (KG)
CO6620NBCA	Acero	■	3 W	300 lm	127-277 V	3 000 K	50 000 h	Driver electrónico	LED Integrado	4°	70	0.9	30	NA	0.2
CO6620NBFA	Acero	■	3 W	300 lm	127-277 V	5 000 K	50 000 h	Driver electrónico	LED Integrado	4°	70	0.9	30	NA	0.2
CO6620NBNA	Acero	■	3 W	300 lm	127-277 V	4 000 K	50 000 h	Driver electrónico	LED Integrado	4°	70	0.9	30	NA	0.2
CO1230BBCA	Aluminio	□	37 W	2400 lm	127-277 V	3 000 K	50 000 h	Driver electrónico	LED Integrado	10°	90	0.95	30	16 mm	1
CO1230NBCA	Aluminio	■	37 W	2400 lm	127-277 V	3 000 K	50 000 h	Driver electrónico	LED Integrado	10°	90	0.95	30	161 mm	1
CO1231BBCA	Aluminio	□	37 W	2400 lm	127-277 V	3 000 K	50 000 h	Driver electrónico	LED Integrado	24°	90	0.95	30	162 mm	1
CO1231NBCA	Aluminio	■	37 W	2400 lm	127-277 V	3 000 K	50 000 h	Driver electrónico	LED Integrado	24°	90	0.95	30	163 mm	1
CO1232BBCA	Aluminio	□	37 W	2400 lm	127-277 V	3 000 K	50 000 h	Driver electrónico	LED Integrado	45°	90	0.95	30	164 mm	1
CO1232NBCA	Aluminio	■	37 W	2400 lm	127-277 V	3 000 K	50 000 h	Driver electrónico	LED Integrado	45°	90	0.95	30	165 mm	1

PEDESTAL



CO7001NBCB

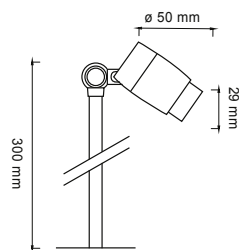
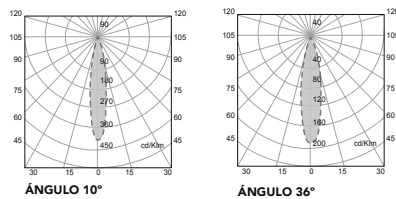

CO7000NBCB

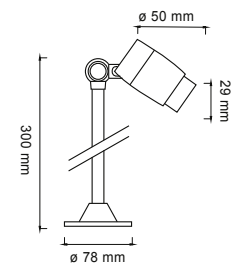
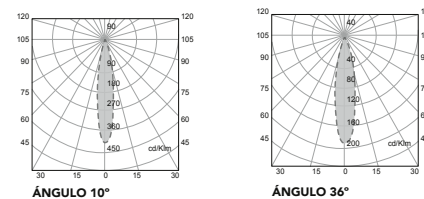
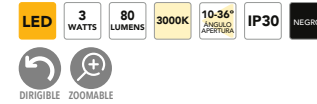

BENEFICIOS

- Luminario discreto y estético.
- Amplia direccionalidad para dirigir el haz de luz.
- Ángulo de luz ajustable para centrar la atención en los objetos que se exhiben, a través de la luz.

CÓDIGO	MATERIAL DE CUERPO	COLOR	POTENCIA	FLUJO LUMINOSO	lm/W	ALIMENTACIÓN	TCC	VIDA ÚTIL (L80)	DRIVER	FUENTE DE LUZ	ÁNGULO DE APERTURA	IRC	FP	IP	PESO (KG)
CO7001NBCB	Aluminio	■	3 W	80 lm	27	127-220 V	3 000 K	30 000 h	Driver electrónico	LED Integrado	10-36°	80	0.9	30	0.1
CO7000NBCB	Aluminio	■	3 W	80 lm	27	127-220 V	3 000 K	30 000 h	Driver electrónico	LED Integrado	10-36°	80	0.9	30	0.1

MAGNÉTICOS



MT5010NBCV

LED 4.5 WATTS 416 LUMENS 3000K 37° ANGLULO APERTURA IP20 NEGRO

NUEVO

DIMABLE 0-10 V VIA DRIVER

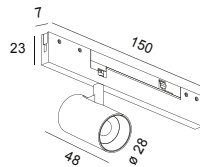
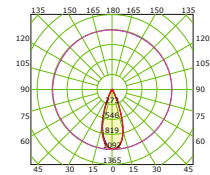

MT5011NBCV

LED 7 WATTS 416 LUMENS 3000K 39° ANGLULO APERTURA IP20 NEGRO

NUEVO

DIMABLE 0-10 V VIA DRIVER

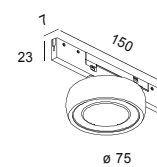
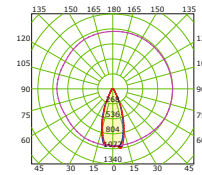

MT5012BBCV

LED 4.5 WATTS 247 LUMENS 3000K 220° ANGLULO APERTURA IP20 BLANCO

NUEVO

DIMABLE 0-10 V VIA DRIVER

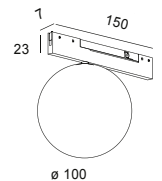
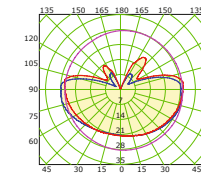

MT5020BBCV

LED 7 WATTS 691 LUMENS 3000K 37° ANGLULO APERTURA IP20 BLANCO

NUEVO

DIMABLE 0-10 V VIA DRIVER

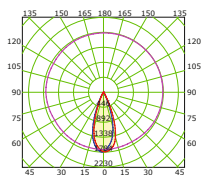
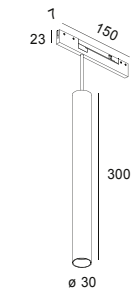

MT5021BBCV

LED 4.5 WATTS 247 LUMENS 3000K 220° ANGLULO APERTURA IP20 BLANCO

NUEVO

DIMABLE 0-10 V VIA DRIVER

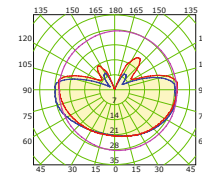
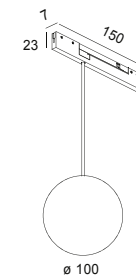

CODIGO	MATERIAL DE CUERPO	COLOR	POTENCIA	FLUJO LUMINOSO	ALIMENTACIÓN	TCC	VIDA ÚTIL (L80)	DRIVER	FUENTE DE LUZ	ÁNGULO DE APERTURA (VxH)	IRC	IP	PESO (KG)
MT5010NBCV	Aluminio / PC	■	4.5 W	416 lm	42 VCD	3 000 K	30000 h	No incluye Driver	LED Integrado	37°	90	20	0.12
MT5011NBCV	Aluminio / PC	■	7 W	416 lm	42 VCD	3 000 K	30000 h	No incluye Driver	LED Integrado	39°	90	20	0.22
MT5012BBCV	Aluminio / Cristal	□	4.5 W	247 lm	42 VCD	3 000 K	30000 h	No incluye Driver	LED Integrado	220°	90	20	0.3
MT5020BBCV	Aluminio / PC	□	7 W	691 lm	42 VCD	3 000 K	30000 h	No incluye Driver	LED Integrado	37°	90	20	0.39
MT5021BBCV	Aluminio / Cristal	□	4.5 W	247 lm	42 VCD	3 000 K	30000 h	No incluye Driver	LED Integrado	220°	90	20	0.32

*Sistema ultradelgado de rieles con luminarios de fijación magnética.
 *Versatilidad para instalar luminarios dirigibles de acento, lineales y suspendidos
 *Accesorios de conexión para crear líneas continuas en muro y plafón

*Construlita se reserva el derecho de modificar la información sin previo aviso y no se hace responsable por errores u omisiones en este documento.

MT1001NBCV

LED 12 WATTS 290 LUMENS 3000K 117° ANGLULO APERTURA IP20 NEGRO

NUEVO

DIMBLEABLE
0-10 V
VIA
DRIVER

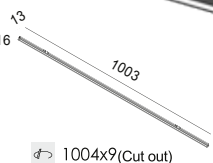
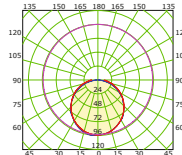

1004x9 (Cut out)

MT4001NBCV

LED 12 WATTS 290 LUMENS 3000K 117° ANGLULO APERTURA IP20 NEGRO

NUEVO

DIMBLEABLE
0-10 V
VIA
DRIVER

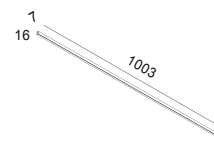
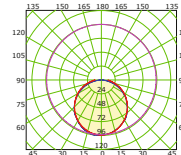
**MT1002NBCV**

LED 24 WATTS 581 LUMENS 3000K 117° ANGLULO APERTURA IP20 NEGRO

NUEVO

DIMBLEABLE
0-10 V
VIA
DRIVER

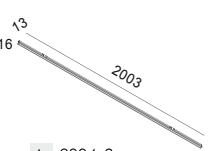
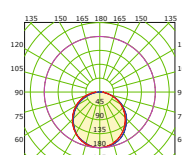

2004x9 (Cut out)

MT4002NBCV

LED 24 WATTS 581 LUMENS 3000K 117° ANGLULO APERTURA IP20 NEGRO

NUEVO

DIMBLEABLE
0-10 V
VIA
DRIVER

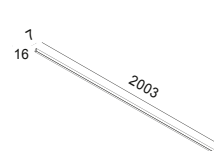
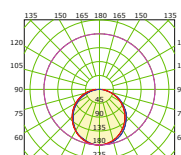
**MT1003NBCV**

LED 36 WATTS 871 LUMENS 3000K 117° ANGLULO APERTURA IP20 NEGRO

NUEVO

DIMBLEABLE
0-10 V
VIA
DRIVER

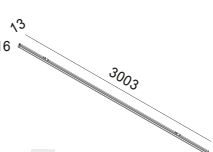
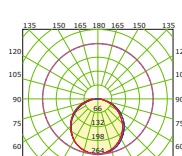

3004x9 (Cut out)

MT4003NBCV

LED 36 WATTS 871 LUMENS 3000K 117° ANGLULO APERTURA IP20 NEGRO

NUEVO

DIMBLEABLE
0-10 V
VIA
DRIVER

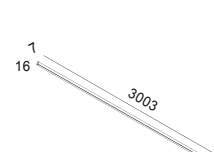
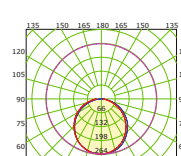
**MT6001NBCV**

LED 24 WATTS 395 LUMENS 3000K 117° ANGLULO APERTURA IP20 NEGRO

NUEVO

DIMBLEABLE
0-10 V
VIA
DRIVER

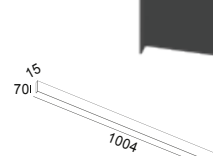
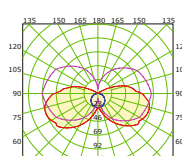
**MT6002NBCV**

LED 48 WATTS 1162 LUMENS 3000K 117° ANGLULO APERTURA IP20 NEGRO

NUEVO

DIMBLEABLE
0-10 V
VIA
DRIVER

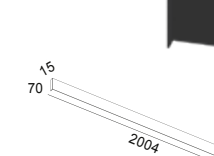
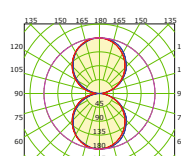

CODIGO	MATERIAL DE CUERPO	COLOR	POTENCIA	FLUJO LUMINOSO	ALIMENTACIÓN	TCC	VIDA ÚTIL (L80)	DRIVER	FUENTE DE LUZ	ÁNGULO DE APERTURA (VxH)	IRC	IP	CORTE DE EMPOTRAMIENTO	PESO (KG)
MT1001NBCV	Aluminio / PC	■	12 W	290 lm	42 VCD	3 000 K	30000 h	No incluye Driver	LED Integrado	117°	90	20	1006 x 9 mm	0.23
MT4001NBCV	Aluminio / PC	■	12 W	290 lm	42 VCD	3 000 K	30000 h	No incluye Driver	LED Integrado	117°	90	20	-	0.21
MT1002NBCV	Aluminio / PC	■	24 W	581 lm	42 VCD	3 000 K	30000 h	No incluye Driver	LED Integrado	117°	90	20	2009 x 9 mm	0.45
MT4002NBCV	Aluminio / PC	■	24 W	581 lm	42 VCD	3 000 K	30000 h	No incluye Driver	LED Integrado	117°	90	20	-	0.45
MT1003NBCV	Aluminio / PC	■	36 W	871 lm	42 VCD	3 000 K	30000 h	No incluye Driver	LED Integrado	117°	90	20	3012 x 9 mm	0.65
MT4003NBCV	Aluminio / PC	■	36 W	871 lm	42 VCD	3 000 K	30000 h	No incluye Driver	LED Integrado	117°	90	20	-	0.6
MT6001NBCV	Aluminio / PC	■	24 W	395 lm	42 VCD	3 000 K	30000 h	No incluye Driver	LED Integrado	117°	90	20	-	0.58
MT6002NBCV	Aluminio / PC	■	48 W	1162 lm	42 VCD	3 000 K	30000 h	No incluye Driver	LED Integrado	117°	90	20	-	1.1

*Sistema ultradelgado de rieles con luminarios de fijación magnética

*Versatilidad para instalar luminarios dirigibles de acento, lineales y suspendidos

*Accesorios de conexión para crear líneas continuas en muro y plafón

MT8001NBCV

LED 12 WATTS 480 LUMENS 3000K 118° ANGLULO APERTURA IP20 NEGRO

NUEVO

DIMBLEABLE 0-10 V VIA DRIVER

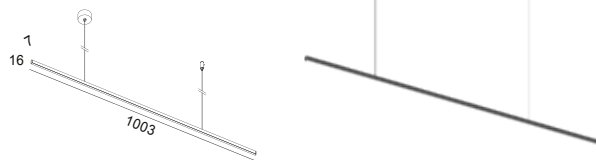
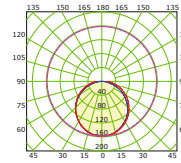

MT8002NBCV

LED 24 WATTS 960 LUMENS 3000K 118° ANGLULO APERTURA IP20 NEGRO

NUEVO

DIMBLEABLE 0-10 V VIA DRIVER

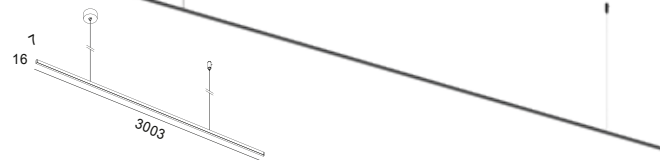
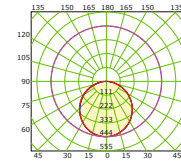

MT8003NBCV

LED 36 WATTS 1440 LUMENS 3000K 117° ANGLULO APERTURA IP20 NEGRO

NUEVO

DIMBLEABLE 0-10 V VIA DRIVER

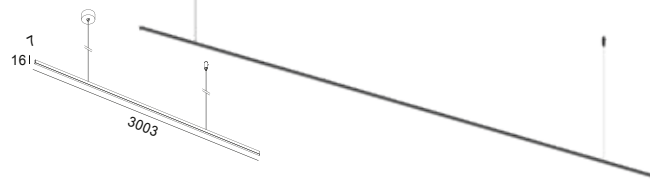
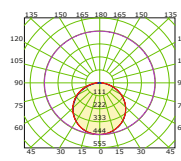

MT5001NBCV

LED 12 WATTS 290 LUMENS 3000K 117° ANGLULO APERTURA IP20 NEGRO

NUEVO

DIMBLEABLE 0-10 V VIA DRIVER

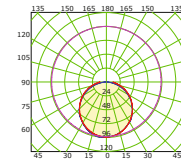

MT5002NBCV

LED 24 WATTS 581 LUMENS 3000K 117° ANGLULO APERTURA IP20 NEGRO

NUEVO

DIMBLEABLE 0-10 V VIA DRIVER

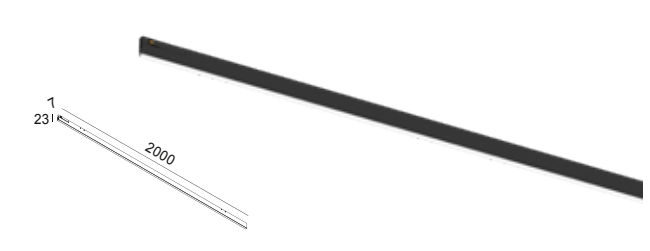
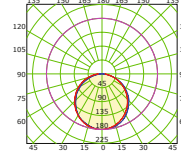

MT5003NBCV

LED 36 WATTS 871 LUMENS 3000K 117° ANGLULO APERTURA IP20 NEGRO

NUEVO

DIMBLEABLE 0-10 V VIA DRIVER

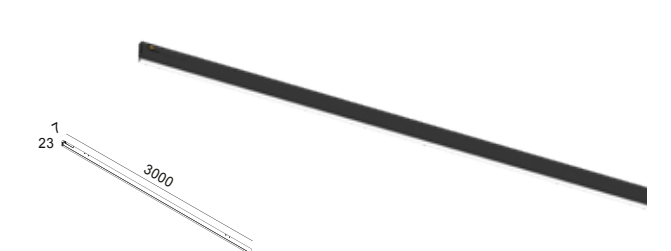
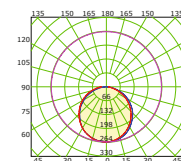

ACCESORIOS



AC5501N
Riel magnético 1 metro
pag. 223



AC5502N
Riel magnético 2 metros
pag. 223



AC5503N
Riel magnético 3 metros
pag. 223



AC5520N
Conector doble
pag. 223



AC5521N
Conector Sencillo
pag. 223



AC5530N
Tapa final
pag. 223



AC5531N
Conector de rieles
pag. 223



AC5510N
Conector tipo codo
pag. 223

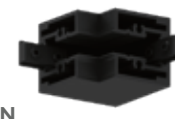

AC5511N
Conector tipo codo
pag. 223

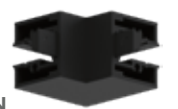

AC5512N
Conector tipo codo
pag. 223

CODIGO	MATERIAL DE CUERPO	COLOR	POTENCIA	FLUJO LUMINOSO	ALIMENTACIÓN	TCC	VIDA ÚTIL(L80)	DRIVER	FUENTE DE LUZ	ÁNGULO DE APERTURA (VxH)	IRC	IP	PESO (KG)
MT8001NBCV	Aluminio / PC	■	12 W	480 lm	42 VCD	3 000 K	30000 h	No incluye Driver	LED Integrado	118°	90	20	0.82
MT8002NBCV	Aluminio / PC	■	24 W	960 lm	42 VCD	3 000 K	30000 h	No incluye Driver	LED Integrado	118°	90	20	0.82
MT8003NBCV	Aluminio / PC	■	36 W	1440 lm	42 VCD	3 000 K	30000 h	No incluye Driver	LED Integrado	118°	90	20	0.82
MT5001NBCV	Aluminio / PC	■	12 W	290 lm	42 VCD	3 000 K	30000 h	No incluye Driver	LED Integrado	117°	90	20	0.82
MT5002NBCV	Aluminio / PC	■	24 W	581 lm	42 VCD	3 000 K	30000 h	No incluye Driver	LED Integrado	117°	90	20	0.82
MT5003NBCV	Aluminio / PC	■	36 W	871 lm	42 VCD	3 000 K	30000 h	No incluye Driver	LED Integrado	117°	90	20	0.82

*Sistema ultradelgado de rieles con luminarios de fijación magnética
*Versatilidad para instalar luminarios dirigibles de acento, lineales y suspendidos
*Accesorios de conexión para crear líneas continuas en muro y plafón

LUMINARIOS DE RIEL



CO5094NBCB

LED 12 WATTS 990 LUMENS 3000K 24° ANGLULO APERTURA IP30 NEGRO

1 FASE

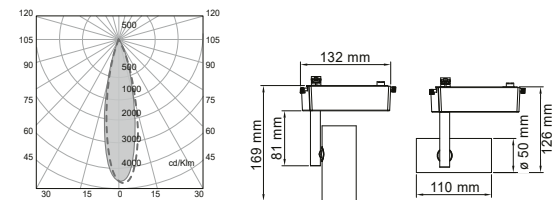

CO5095NBCB

LED 25 WATTS 2150 LUMENS 3000K 24° ANGLULO APERTURA IP30 NEGRO

1 FASE

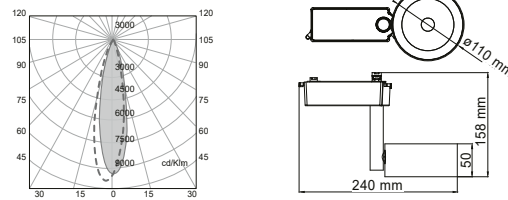

CO5096NBCB

LED 35 WATTS 3000 LUMENS 3000K 24° ANGLULO APERTURA IP30 NEGRO

1 FASE

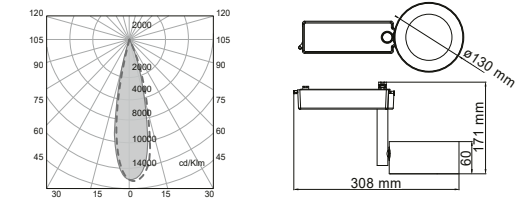

CO5112BBCA

LED 30 WATTS 2600 LUMENS 3000K 24/36/60° ANGLULO APERTURA IP20 BLANCO

CO5112NBCA

LED 30 WATTS 2600 LUMENS 4000K 24/36/60° ANGLULO APERTURA IP20 NEGRO

*Compatible con rieles YS-100 y YS-200 marca Tecnolite
*Ópticas intercambiables incluidas

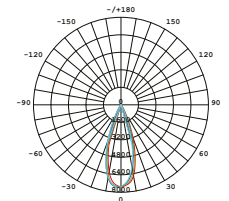
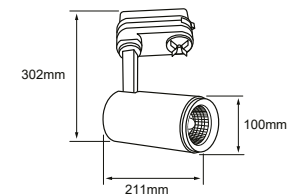

CO5113BBCA

LED 45 WATTS 4000 LUMENS 3000K 24/36/60° ANGLULO APERTURA IP20 BLANCO

NUEVO

CO5113NBCA

LED 45 WATTS 4000 LUMENS 4000K 24/36/60° ANGLULO APERTURA IP20 NEGRO

*Ópticas intercambiables incluidas con ángulos de 24°, 36° y 60°

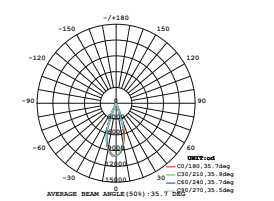
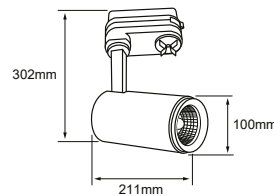

ACCESORIO

AC5090
Cylinder ELEMENTAL
riel 1 fase pag. 222

ACCESORIO

AC5093N
Conector cruz riel
ELEMENTAL pag. 222.

ACCESORIO

AC5092N
Conector flex riel
ELEMENTAL pag. 222

ACCESORIO

AC5091N
Conector recto riel
ELEMENTAL pag. 222

ACCESORIO

AC5096N
Conector t der riel
ELEMENTAL pag. 222

ACCESORIO

AC5097N
Conector t izq riel
ELEMENTAL pag. 222

CÓDIGO	MATERIAL DE CUERPO	COLOR	POTENCIA	FLUJO LUMINOSO	ALIMENTACIÓN	TCC	VIDA ÚTIL (L80)	DRIVER	FUENTE DE LUZ	ÁNGULO DE APERTURA (VxH)	IRC	FP	IP	PESO (KG)
CO5094NBCB	Aluminio	■	12 W	990 lm	127-220 V	3 000 K	30 000 h	Driver electrónico	LED Integrado	24°	80	0.9	30	0.25
CO5095NBCB	Aluminio	■	25 W	2150 lm	127-220 V	3 000 K	30 000 h	Driver electrónico	LED Integrado	24°	80	0.9	30	0.31
CO5096NBCB	Aluminio	■	35 W	3000 lm	127-220 V	3 000 K	30 000 h	Driver electrónico	LED Integrado	24°	80	0.9	30	0.36
CO5112BBCA	Aluminio	□	30 W	2600 lm	100-277 V ~	3 000 K	50000 h	Driver electrónico	LED Integrado	24/36/60°	90	0.9	20	1
CO5112NBCA	Aluminio	■	30 W	2600 lm	100-277 V ~	4 000 K	50000 h	Driver electrónico	LED Integrado	24/36/60°	90	0.9	20	1
CO5113BBCA	Aluminio	□	45 W	4000 lm	100-277 V ~	3 000 K	50000 h	Driver Electrónico	LED Integrado	24/36/60°	90	0.9	20	1
CO5113NBCA	Aluminio	■	45 W	4000 lm	100-277 V ~	4 000 K	50000 h	Driver Electrónico	LED Integrado	24/36/60°	90	0.9	20	1

CO5082BBCA

LED 20 WATTS 1292 LUMENS 3000K 30° ANGULO APERTURA IP20 BLANCO

NUEVO

CO5082NBCA

LED 20 WATTS 1292 LUMENS 3000K 30° ANGULO APERTURA IP20 NEGRO

1

FASE

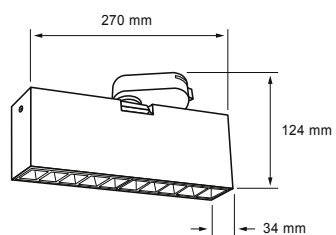
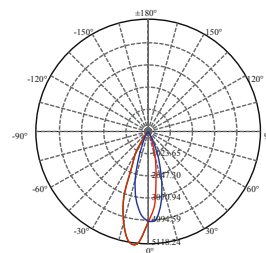

CO5083BBCA

LED 30 WATTS 2035 LUMENS 3000K 30° ANGULO APERTURA IP20 BLANCO

NUEVO

CO5083NBCA

LED 30 WATTS 2035 LUMENS 3000K 30° ANGULO APERTURA IP20 NEGRO

1

FASE

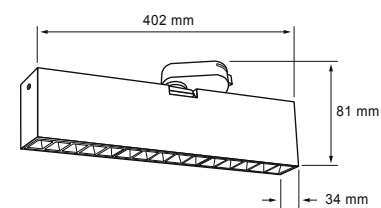
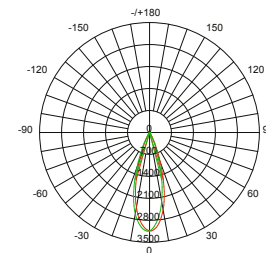

CO5080BBCA

LED 37 WATTS 1100 LUMENS 3000K WW ANGULO APERTURA IP20 BLANCO

CO5080NBCA

LED 37 WATTS 1100 LUMENS 3000K WW ANGULO APERTURA IP20 NEGRO



DIMIABLE 0-10 V

1

FASE

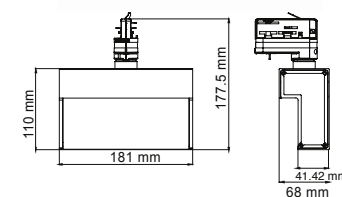
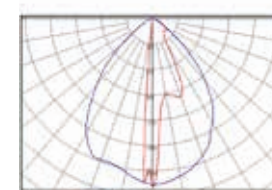

ACCESORIO

AC4050B

AC4050N

Canopy de tres fases.

CÓDIGO	MATERIAL DE CUERPO	COLOR	POTENCIA	FLUJO LUMINOSO	ALIMENTACIÓN	TCC	VIDA ÚTIL (L80)	DRIVER	FUENTE DE LUZ	ÁNGULO DE APERTURA (VxH)	IRC	FP	IP	PESO (KG)
CO5082BBCA	Aluminio	□	20 W	1292 lm	100-277V ~	3 000 K	50 000 h	Driver electrónico	LED Integrado	30°	90	0.9	20	2.4
CO5082NBCA	Aluminio	■	20 W	1292 lm	100-277V ~	3 000 K	50 000 h	Driver electrónico	LED Integrado	30°	90	0.9	20	2.4
CO5083BBCA	Aluminio	□	30 W	2035 lm	100-277V ~	3 000 K	50 000 h	Driver electrónico	LED Integrado	30°	90	0.9	20	1.095
CO5083NBCA	Aluminio	■	30 W	2035 lm	100-277V ~	3 000 K	50 000 h	Driver electrónico	LED Integrado	30°	90	0.9	20	1.095
CO5080BBCA	Aluminio	□	37 W	1100 lm	127-277 V	3 000 K	50 000 h	Driver electrónico	LED Integrado	WW	92	0.95	30	1.6
CO5080NBCA	Aluminio	■	37 W	1100 lm	127-277 V	3 000 K	50 000 h	Driver electrónico	LED Integrado	WW	92	0.95	30	1.6

CO5066NBCD

LED 14 WATTS 1010 LUMENS 3000K 36° ANGLULO APERTURA IP30 NEGRO

1 FASE

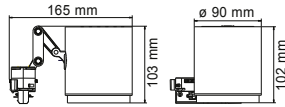
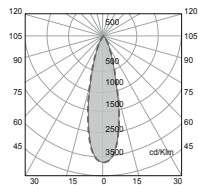

CO5065BBCB

LED 14 WATTS 1160 LUMENS 3000K 24° ANGLULO APERTURA IP30 BLANCO

1 FASE

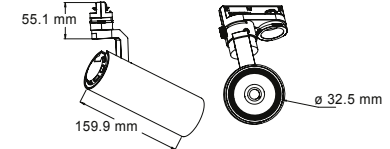
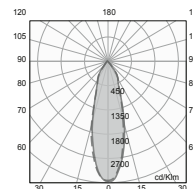

CO5076NBCA

LED 1x17 WATTS 1367 LUMENS 2700K 24° ANGLULO APERTURA IP30 NEGRO

1 FASE

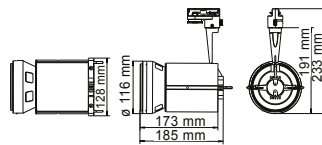
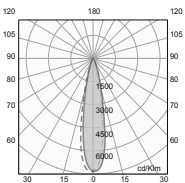

CO5074BBCA

LED 10 WATTS 960 LUMENS 2700K 24° ANGLULO APERTURA IP30 BLANCO

1 FASE

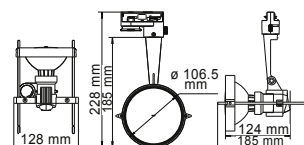
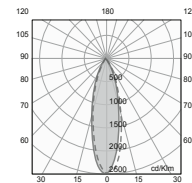

CO5075BBCD

LED 1x6 WATTS 500 LUMENS 3000K 36° ANGLULO APERTURA IP30 BLANCO

1 FASE

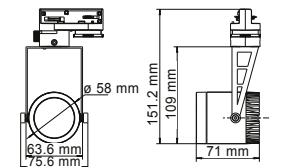
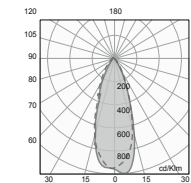

ACCESORIO

AC5040N

Junta flexible color negro

ACCESORIO

AC5040B

Junta flexible color blanco

ACCESORIO

AC5041B

Riel de 1 fase 2 m color blanco

ACCESORIO

AC5041N

Riel de 1 fase 2 m color negro

CÓDIGO	MATERIAL DE CUERPO	COLOR	POTENCIA	FLUJO LUMINOSO	ALIMENTACIÓN	TCC	VIDA ÚTIL (L80)	DRIVER	FUENTE DE LUZ	ÁNGULO DE APERTURA (VxH)	IRC	FP	IP	PESO (KG)
CO5066NBCD	Aluminio	■	14 W	1010 lm	127 V	3 000 K	25 000 h	Driver electrónico	LED Integrado	36°	90	0.9	30	0.125
CO5065BBCB	Aluminio	□	14 W	1160 lm	127-220 V	3 000 K	25 000 h	Driver electrónico	LED Integrado	24°	90	0.9	30	0.66
CO5065NBCB	Aluminio	■	14 W	1160 lm	127-220 V	3 000 K	25 000 h	Driver electrónico	LED Integrado	24°	90	0.9	30	0.66
CO5076NBCA	Aluminio	■	1x17 W	1367 lm	127-277 V	2 700 K	25 000 h	-	AR111 (Incluido)	24°	80	0.9	30	0.98
CO5074BBCA	Aluminio	□	10 W	960 lm	127-277 V	2 700 K	25 000 h	-	PAR30 (Incluido)	24°	80	0.8	30	0.5
CO5075BBCD	Aluminio	□	1x6 W	500 lm	127 V	3 000 K	25 000 h	-	MR16 (Incluido)	36°	80	0.9	30	0.304
CO5075NBCD	Aluminio	■	1x6 W	500 lm	127 V	3 000 K	25 000 h	-	MR16 (Incluido)	36°	80	0.9	30	0.304

CO5050BBCA

LED 37 WATTS 2400 LUMENS 3000K 10° ANGLULO APERTURA IP30 BLANCO

CO5050NBCA

LED 37 WATTS 2400 LUMENS 3000K 10° ANGLULO APERTURA IP30 NEGRO

CO5051BBCA

LED 37 WATTS 2400 LUMENS 3000K 24° ANGLULO APERTURA IP30 BLANCO

CO5051NBCA

LED 37 WATTS 2400 LUMENS 3000K 24° ANGLULO APERTURA IP30 NEGRO

CO5052BBCA

LED 37 WATTS 2400 LUMENS 3000K 45° ANGLULO APERTURA IP30 BLANCO

CO5052NBCA

LED 37 WATTS 2400 LUMENS 3000K 45° ANGLULO APERTURA IP30 NEGRO



CO5256BBCA

LED 30 WATTS 3120 LUMENS 3000K 24° ANGLULO APERTURA IP30 BLANCO

CO5257BBCA

LED 30 WATTS 3120 LUMENS 3000K 10° ANGLULO APERTURA IP30 BLANCO

CO5258BBCA

LED 30 WATTS 3120 LUMENS 3000K 45° ANGLULO APERTURA IP30 BLANCO

CO5258NBCA

LED 30 WATTS 3120 LUMENS 3000K 45° ANGLULO APERTURA IP30 NEGRO



CO5250BBCA

LED 37 WATTS 2400 LUMENS 3000K 24° ANGLULO APERTURA IP30 BLANCO

CO5250NBCA

LED 37 WATTS 2400 LUMENS 3000K 24° ANGLULO APERTURA IP30 NEGRO

CO5251NBCA

LED 37 WATTS 2400 LUMENS 3000K 10° ANGLULO APERTURA IP30 NEGRO

CO5252NBCA

LED 37 WATTS 2400 LUMENS 3000K 10° ANGLULO APERTURA IP30 NEGRO



CO5253BBCA

LED 37 WATTS 2800 LUMENS 3000K 24° ANGLULO APERTURA IP30 NEGRO

CO5255BBCA

LED 37 WATTS 2800 LUMENS 3000K 45° ANGLULO APERTURA IP30 BLANCO

CO5255NBCA

LED 37 WATTS 2800 LUMENS 3000K 45° ANGLULO APERTURA IP30 NEGRO

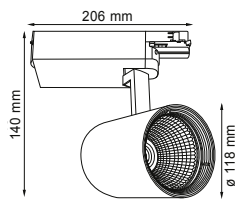
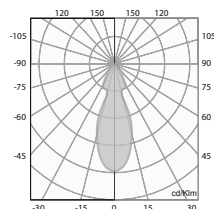

CÓDIGO	MATERIAL DE CUERPO	COLOR	POTENCIA	FLUJO LUMINOSO	ALIMENTACIÓN	TCC	VIDA ÚTIL (L80)	DRIVER	FUENTE DE LUZ	ÁNGULO DE APERTURA (VxH)	IRC	FP	IP	PESO (KG)
CO5050BBCA	Aluminio	□	37 W	2400 lm	127-277 V	3 000 K	50 000 h	Driver electrónico	LED Integrado	10°	95	0.95	30	1.8
CO5050NBCA	Aluminio	■	37 W	2400 lm	127-277 V	3 000 K	50 000 h	Driver electrónico	LED Integrado	10°	95	0.95	30	1.8
CO5051BBCA	Aluminio	□	37 W	2400 lm	127-277 V	3 000 K	50 000 h	Driver electrónico	LED Integrado	24°	95	0.95	30	1.8
CO5051NBCA	Aluminio	■	37 W	2400 lm	127-277 V	3 000 K	50 000 h	Driver electrónico	LED Integrado	24°	95	0.95	30	1.8
CO5052BBCA	Aluminio	□	37 W	2400 lm	127-277 V	3 000 K	50 000 h	Driver electrónico	LED Integrado	45°	95	0.95	30	1.8
CO5052NBCA	Aluminio	■	37 W	2400 lm	127-277 V	3 000 K	50 000 h	Driver electrónico	LED Integrado	45°	95	0.95	30	1.8
CO5256BBCA	Aluminio	□	30 W	3120 lm	127-277 V	3 000 K	50 000 h	Driver electrónico	LED Integrado	24°	80	0.95	30	1.8
CO5257BBCA	Aluminio	□	30 W	3120 lm	127-277 V	3 000 K	50 000 h	Driver electrónico	LED Integrado	10°	80	0.95	30	1.8
CO5258BBCA	Aluminio	□	30 W	3120 lm	127-277 V	3 000 K	50 000 h	Driver electrónico	LED Integrado	45°	80	0.95	30	1.8
CO5258NBCA	Aluminio	■	30 W	3120 lm	127-277 V	3 000 K	50 000 h	Driver electrónico	LED Integrado	45°	80	0.95	30	1.8
CO5250BBCA	Aluminio	□	37 W	2400 lm	127-277 V	3 000 K	50 000 h	Driver electrónico	LED Integrado	24°	95	0.95	30	1.8
CO5250NBCA	Aluminio	■	37 W	2400 lm	127-277 V	3 000 K	50 000 h	Driver electrónico	LED Integrado	24°	95	0.95	30	1.8
CO5251NBCA	Aluminio	■	37 W	2400 lm	127-277 V	3 000 K	50 000 h	Driver electrónico	LED Integrado	10°	95	0.95	30	1.8
CO5252NBCA	Aluminio	■	37 W	2400 lm	127-277 V	3 000 K	50 000 h	Driver electrónico	LED Integrado	45°	95	0.95	30	1.8
CO5253BBCA	Aluminio	□	37 W	2800 lm	127-277 V	3 000 K	50 000 h	Driver electrónico	LED Integrado	24°	90	0.95	30	1.8
CO5255BBCA	Aluminio	□	37 W	2800 lm	127-277 V	3 000 K	50 000 h	Driver electrónico	LED Integrado	45°	90	0.95	30	1.8
CO5255NBCA	Aluminio	■	37 W	2800 lm	127-277 V	3 000 K	50 000 h	Driver electrónico	LED Integrado	45°	90	0.95	30	1.8

CO5110BBCA

LED 27 WATTS 2500 LUMENS 3000K 24° ANGLULO APERTURA IP30 BLANCO

CO5110NBCA

LED 27 WATTS 2500 LUMENS 3000K 24° ANGLULO APERTURA IP30 NEGRO

3 FASES

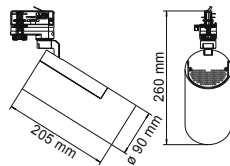
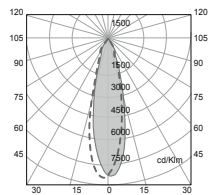

ACCESORIO

AC5431B

AC5431N / Conector de cruz

ACCESORIO

AC5430B

AC5430N / Conector flexible para riel de 3 fases

ACCESORIO

AC5002B

AC5002N / Riel 2 mt. de 3 fases

ACCESORIO

AC5433B

AC5433N / Junta 'T' izquierda

ACCESORIO

AC5432B

AC5432N / Junta 'T' derecha

ACCESORIO

AC5003B

AC5003N / Riel atenuable 1 circuito, 2m.

ACCESORIO

AC5433B

AC5433N / Junta 'T' izquierda

ACCESORIO

AC5430B

AC5430N / Conector flexible para para 3 fases

ACCESORIO

AC5432B

AC5432N / Junta 'T' derecha

ACCESORIO

AC5003B

AC5003N / Riel atenuable 1 circuito, 2m

ACCESORIO

AC5431B

AC5431N / Conector de cruz

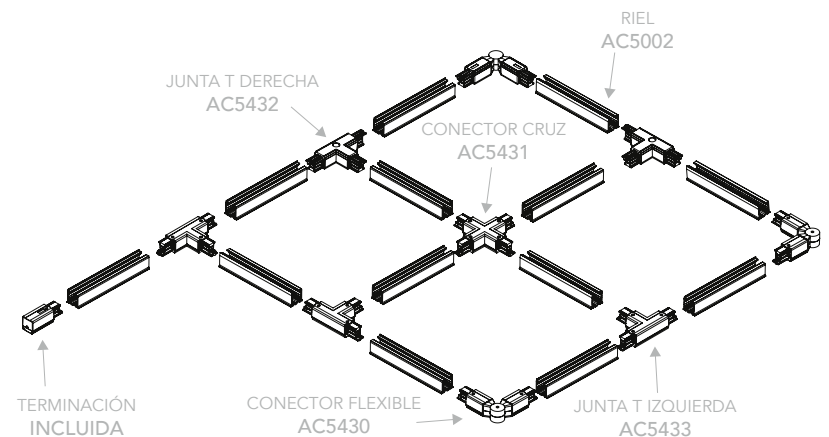

CÓDIGO	MATERIAL DE CUERPO	COLOR	POTENCIA	FLUJO LUMINOSO	ALIMENTACIÓN	TCC	VIDA ÚTIL (L80)	DRIVER	FUENTE DE LUZ	ÁNGULO DE APERTURA (VxH)	IRC	FP	IP	IK	PESO (KG)
CO5110BBCA	Aluminio	□	27 W	2500 lm	127-277 V	3 000 K	30 000 h	Driver electrónico	LED Integrado	24°	90	0.9	30	-	1.2
CO5110NBCA	Aluminio	■	27 W	2500 lm	127-277 V	3 000 K	30 000 h	Driver electrónico	LED Integrado	24°	90	0.9	30	-	1.2

CO5039BBCB

LED 10 WATTS 830 LUMENS 3000K 24° ANGULO APERTURA IP30 BLANCO

CO5039NBCB

LED 10 WATTS 830 LUMENS 3000K 24° ANGULO APERTURA IP30 NEGRO

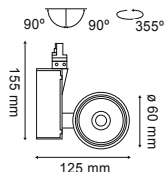
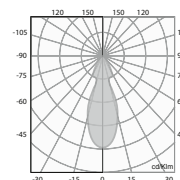
**CO5105BBCA**

LED 20 WATTS 1300 LUMENS 3000K 17-64° ANGULO APERTURA IP30 BLANCO

CO5105NBCA

LED 20 WATTS 1300 LUMENS 3000K 17-64° ANGULO APERTURA IP30 NEGRO

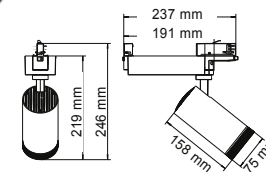
**CO5068BBCD**

LED 40 WATTS 2400 LUMENS 2700K 24° ANGULO APERTURA IP30 BLANCO

CO5068NBCD

LED 40 WATTS 2400 LUMENS 2700K 24° ANGULO APERTURA IP30 NEGRO

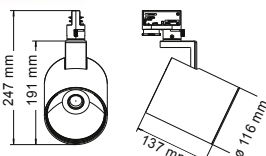
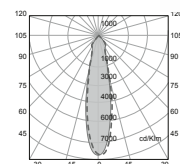
**CO5069BBCA**

LED 40 WATTS 3650 LUMENS 3000K 24° ANGULO APERTURA IP30 BLANCO

CO5069NBCA

LED 40 WATTS 3650 LUMENS 3000K 24° ANGULO APERTURA IP30 NEGRO

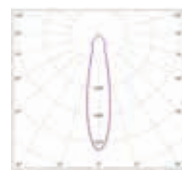
**CO5085BBCA**

LED 36 WATTS 2830 LUMENS 3000K 24° ANGULO APERTURA IP30 BLANCO

CO5085NBCA

LED 36 WATTS 2830 LUMENS 3000K 24° ANGULO APERTURA IP30 NEGRO

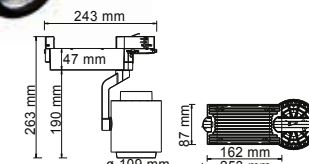
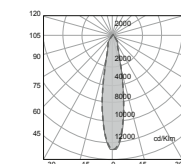
**ACCESORIO****AC5431B**

AC5431N / Conector de cruz

ACCESORIO**AC5433B**

AC5433N / Junta 'T' izquierda

ACCESORIO**AC5430B**

AC5430N / Conector flexible para riel de 3 fases

ACCESORIO**AC5002B**

AC5002N / Riel 2 mt. de 3 fases

ACCESORIO**AC5432B**

AC5432N / Junta 'T' derecha

ACCESORIO**AC5003B**

AC5003N / Riel atenuable 1 circuito, 2m.

CÓDIGO	MATERIAL DE CUERPO	COLOR	POTENCIA	FLUJO LUMINOSO	ALIMENTACIÓN	TCC	VIDA ÚTIL (L80)	DRIVER	FUENTE DE LUZ	ÁNGULO DE APERTURA (vxH)	IRC	FP	IP	PESO (KG)
CO5039BBCB	Aluminio	Blanco	10W	830 lm	127-220 V	3 000 K	25 000 h	Circuito Integrado	LED Integrado	24°	92	0.9	30	0.496
CO5039NBCB	Aluminio	Negro	10W	830 lm	127-220 V	3 000 K	25 000 h	Circuito Integrado	LED Integrado	24°	92	0.9	30	0.496
CO5105BBCA	Aluminio	Blanco	20W	1300 lm	127-277 V	3 000 K	30 000 h	Driver electrónico	LED Integrado	17-64°	92	0.8	30	2.5
CO5105NBCA	Aluminio	Negro	20W	1300 lm	127-277 V	3 000 K	30 000 h	Driver electrónico	LED Integrado	17-64°	92	0.8	30	2.5
CO5068BBCD	Aluminio	Blanco	40W	2400 lm	127 V	2 700 K	25 000 h	Driver electrónico	LED Integrado	24°	90	0.9	30	1.4
CO5068NBCD	Aluminio	Negro	40W	2400 lm	127 V	2 700 K	25 000 h	Driver electrónico	LED Integrado	24°	90	0.9	30	1.4
CO5069BBCA	Aluminio	Blanco	40W	3650 lm	127-277 V	3 000 K	30 000 h	Driver electrónico	LED Integrado	24°	80	0.9	30	1.8
CO5069NBCA	Aluminio	Negro	40W	3650 lm	127-277 V	3 000 K	30 000 h	Driver electrónico	LED Integrado	24°	80	0.9	30	1.8
CO5085BBCA	Aluminio	Blanco	36W	2830 lm	127-277 V	3 000 K	35 000 h	Driver electrónico	LED Integrado	24°	90	0.9	30	2.2
CO5085NBCA	Aluminio	Negro	36W	2830 lm	127-277 V	3 000 K	35 000 h	Driver electrónico	LED Integrado	24°	90	0.9	30	2.2

CO5667NBCA

LED 37 WATTS 2800 LUMENS 3000K 24° ANGULO APERTURA IP30 NEGRO

3
FASES

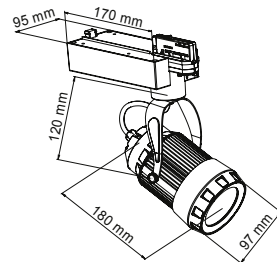
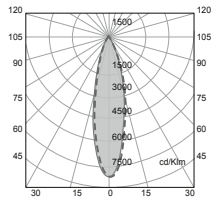

ACCESORIO

AC5431B
AC5431N / Conector de cruz

ACCESORIO

AC5433B
AC5433N / Junta 'T' izquierda

ACCESORIO

AC5432B
AC5432N / Junta 'T' derecha

ACCESORIO

AC5002B
AC5002N / Riel 2 mt. de 3 fases

ACCESORIO

AC5430B
AC5430N / Conector flexible para riel de 3 fases

ACCESORIO

AC5003B
AC5003N / Riel atenuable 1 circuito, 2m.

CO5062BBCA

LED 47 WATTS 3200 LUMENS 3000K 24° ANGULO APERTURA IP30 BLANCO

CO5062NBCA

LED 47 WATTS 3200 LUMENS 3000K 24° ANGULO APERTURA IP30 NEGRO

3
FASES

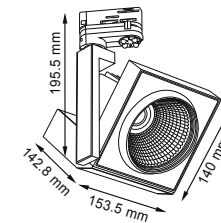
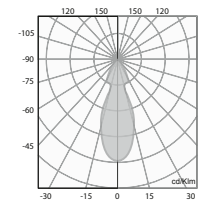

ACCESORIOS

26171
Reflector 45°

26169
Reflector 10°

AC5050N ■
Aletas coratadoras

AC5054N ■
Panel antideslumbrante

ACCESORIO

AC4050B
AC4050N
Canopy de tres fases.

AC5051B □
Lentes ajustables

AC5055N ■
Difusor

AC5052B □
Vicera antideslumbrante

CÓDIGO	MATERIAL DE CUERPO	COLOR	POTENCIA	FLUJO LUMINOSO	ALIMENTACIÓN	TCC	VIDA ÚTIL (L80)	DRIVER	FUENTE DE LUZ	ÁNGULO DE APERTURA (VxH)	IRC	FP	IP	PESO (KG)
CO5667NBCA	Aluminio	■	37 W	2800 lm	127-277 V	3 000 K	50 000 h	Driver electrónico	LED Integrado	24°	90	0.9	30	2.2
CO5062BBCA	Aluminio	□	47 W	3200 lm	127-277 V	3 000 K	25 000 h	Driver electrónico	LED Integrado	24°	90	0.95	30	1.8
CO5062NBCA	Aluminio	■	47 W	3200 lm	127-277 V	3 000 K	25 000 h	Driver electrónico	LED Integrado	24°	90	0.95	30	1.8

CO5070BBCA

LED	37 WATTS	3200 LUMENS	3000K	24° ÁNGULO DE APERTURA	IP30	BLANCO
-----	----------	-------------	-------	---------------------------	------	--------

CO5070NBCA

LED	37 WATTS	3200 LUMENS	3000K	24° ÁNGULO DE APERTURA	IP30	NEGRO
-----	----------	-------------	-------	---------------------------	------	-------

3

FASES

CO5071BBCA

LED	10 WATTS	1100 LUMENS	3000K	24° ÁNGULO DE APERTURA	IP20	BLANCO
-----	----------	-------------	-------	---------------------------	------	--------

CO5071NBCA

LED	10 WATTS	690 LUMENS	3000K	24° ÁNGULO DE APERTURA	IP30	NEGRO
-----	----------	------------	-------	---------------------------	------	-------

3

FASES

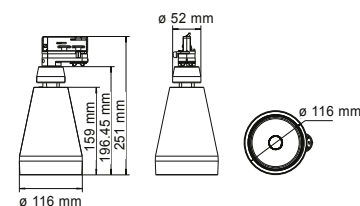
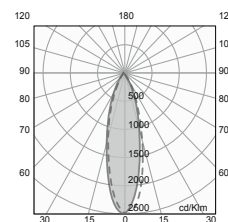
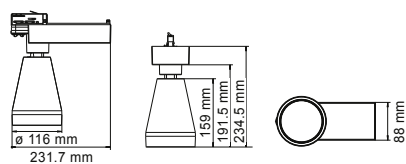
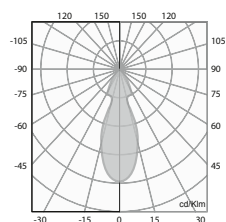
**ACCESORIO****AC5430B**
AC5430N

Conector flexible para riel de 3 fases

ACCESORIO**AC5432B**
AC5432N

Junta 'T' derecha

ACCESORIO**AC5431B**
AC5431N

Conector de cruz

ACCESORIO**AC5433B**
AC5433N

Junta 'T' izquierda

ACCESORIO**AC5002B**
AC5002N

Riel 2 mt. de 3 fases

ACCESORIO PARA CO5071**AC4050B**
AC4050N

Canopy de tres fases.

CÓDIGO	MATERIAL DE CUERPO	COLOR	POTENCIA	FLUJO LUMINOSO	ALIMENTACIÓN	TCC	VIDA ÚTIL (L80)	DRIVER	FUENTE DE LUZ	ÁNGULO DE APERTURA (vxH)	IRC	FP	IP	PESO (KG)
CO5070BBCA	Aluminio	□	37 W	3200 lm	127-277 V	3 000 K	50 000 h	Driver electrónico	LED Integrado	24°	92	0.9	30	1.5
CO5070NBCA	Aluminio	■	37 W	3200 lm	127-277 V	3 000 K	50 000 h	Driver electrónico	LED Integrado	24°	92	0.9	30	1.5
CO5071BBCA	Aluminio	□	10 W	1 100 lm	127-277 V	3 000 K	25 000 h	-	PAR30	24°	80	0.9	20	1
CO5071NBCA	Aluminio	■	10 W	960 lm	127-277 V	3 000 K	25 000 h	-	PAR30 (Incluido)	24°	80	0.9	30	0.86



DECORATIVO



RE8052NBCB

LED 45 WATTS 3150 LUMENS 3000K 180° ANGULO APERTURA IP20 NEGRO

NUEVO

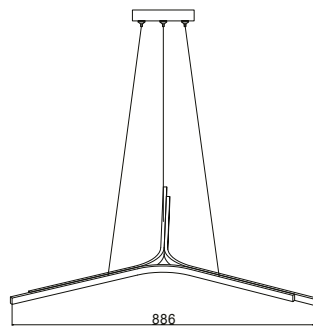

RE8049NBCB

LED 56 WATTS 2898 LUMENS 3000K 120° ANGULO APERTURA IP20 NEGRO

NUEVO

RE8049DBC

LED 56 WATTS 2898 LUMENS 3000K 120° ANGULO APERTURA IP20 DORADO

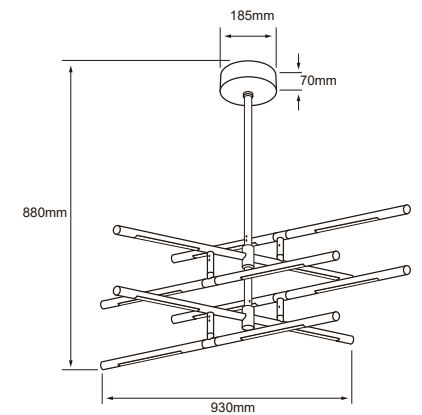

CÓDIGO	MATERIAL DE CUERPO	COLOR	POTENCIA	FLUJO LUMINOSO	ALIMENTACIÓN	TCC	VIDA ÚTIL (L80)	DRIVER	FUENTE DE LUZ	ÁNGULO DE APERTURA (VxH)	IRC	FP	IP	PESO (KG)
RE8052NBCB	Aluminio	■	45 W	3150 lm	100-240 V ~	3 000 K	30000 h	Driver Electrónico	LED Integrado	180°	80	0.7	20	2.7
RE8049NBCB	Aluminio/Acrylic	■	56 W	2898 lm	100-240 V ~	3 000 K	30000 h	Driver Electrónico	LED Integrado	120°	80	0.7	20	2.7
RE8049DBC	Aluminio/Acrylic	■	56 W	2898 lm	100-240 V ~	3 000 K	30000 h	Driver Electrónico	LED Integrado	120°	80	0.7	20	2.7

RE8055NBCB

LED	38.5 WATTS	1713 LUMENS	3000K	360° ÁNGULO DE APERTURA	IP20	NEGRO
-----	------------	-------------	-------	----------------------------	------	-------

NUEVO

RE8055DBC

LED	38.5 WATTS	1713 LUMENS	3000K	360° ÁNGULO DE APERTURA	IP20	DORADO
-----	------------	-------------	-------	----------------------------	------	--------

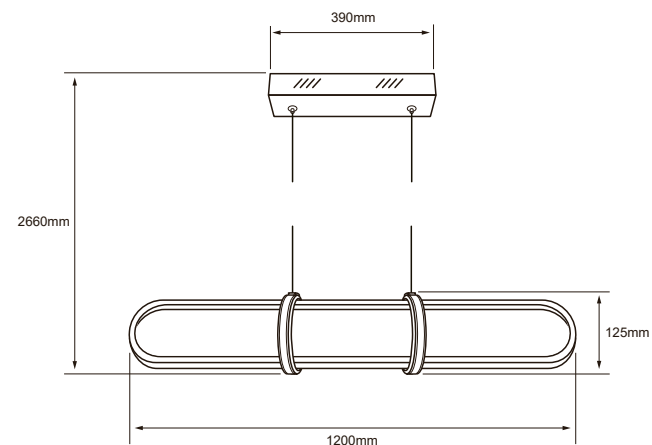
DIMMEABLE
0-10 V

CÓDIGO	MATERIAL DE CUERPO	COLOR	POTENCIA	FLUJO LUMINOSO	ALIMENTACIÓN	TCC	VIDA ÚTIL (L80)	DRIVER	FUENTE DE LUZ	ÁNGULO DE APERTURA (VxH)	IRC	FP	IP	PESO (KG)
RE8055NBCB	Aluminio/Acrílico	■	38.5 W	1713 lm	100-240 V ~	■ 3 000 K	30000 h	Driver Electrónico	LED Integrado	360°	80	0.7	20	2.7
RE8055DBC	Aluminio/Acrílico	■	38.5 W	1713 lm	100-240 V ~	■ 3 000 K	30000 h	Driver Electrónico	LED Integrado	360°	80	0.7	20	2.7

RE8131BBCB

LED 72 WATTS 5500 LUMENS 3000K 120° ANGULO APERTURA IP30 BLANCO



RE8130NBCB

LED 65 WATTS 4880 LUMENS 3000K 120° ANGULO APERTURA IP30 NEGRO

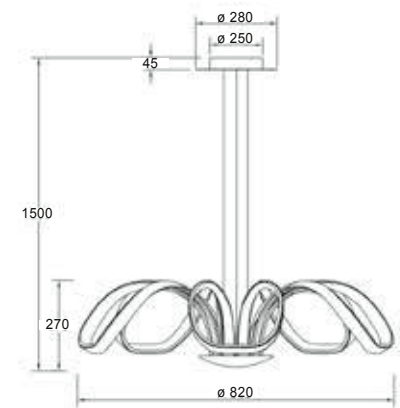
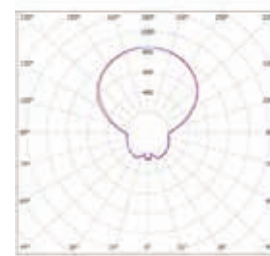
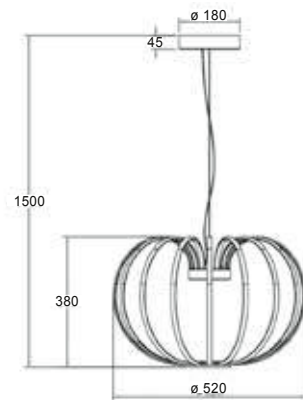
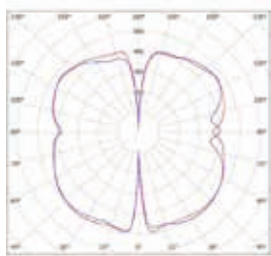

CÓDIGO	MATERIAL DE CUERPO	COLOR	POTENCIA	FLUJO LUMINOSO	ALIMENTACIÓN	TCC	VIDA ÚTIL (L80)	DRIVER	FUENTE DE LUZ	ÁNGULO DE APERTURA (VxH)	IRC	FP	IP	PESO (KG)
RE8131BBCB	Aluminio	□	72 W	5500 lm	127-220 V	3 000 K	30 000 h	Driver electrónico	LED Integrado	120°	80	0.65	30	3
RE8130NBCB	Aluminio	■	65 W	4880 lm	127-220 V	3 000 K	30 000 h	Driver electrónico	LED Integrado	120°	80	0.99	30	5.6

RE8099NBCB

LED 25 WATTS 590 LUMENS 3000K 120° ANGULO APERTURA IP20 ND



NUEVO

RE8140NBCB

LED 72 WATTS 4320 LUMENS 3000K 360° ANGULO APERTURA IP20 NEGRO



NUEVO

RE8056NBCB

LED 48 WATTS 2940 LUMENS 3000K 180° ANGULO APERTURA IP20 NEGRO

NUEVO

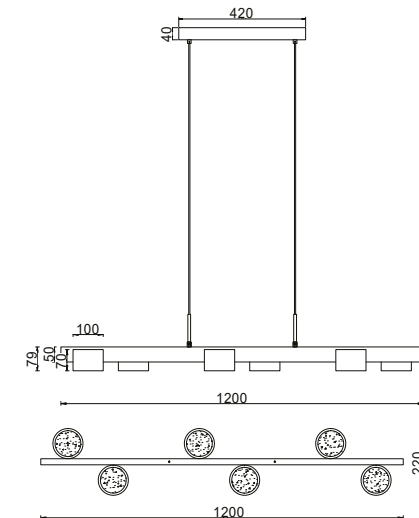
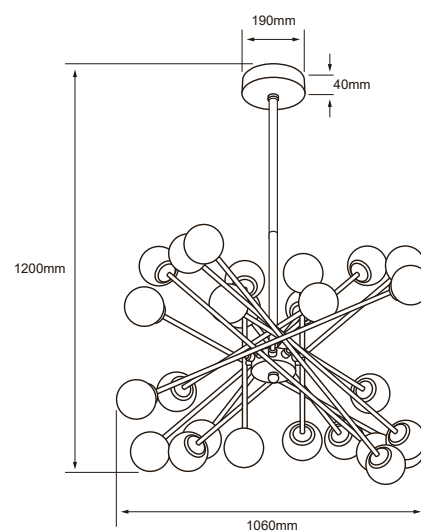
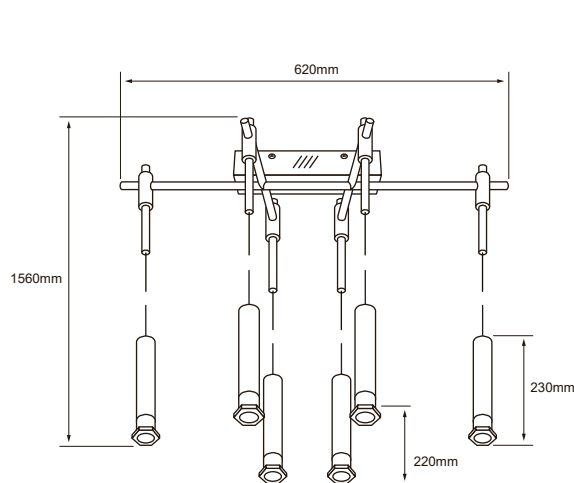

CODIGO	MATERIAL DE CUERPO	COLOR	POTENCIA	FLUJO LUMINOSO	ALIMENTACIÓN	TCC	VIDA ÚTIL (L80)	DRIVER	FUENTE DE LUZ	ÁNGULO DE APERTURA (VxH)	IRC	FP	IP	PESO (KG)
RE8099NBCB	Aluminio/Acrílico	□	25 W	590 lm	100-277 V ~	3 000 K	30000 h	Driver Electrónico	LED Integrado	120°	80	0.7	20	3
RE8140NBCB	Aluminio/Acrílico	■	72 W	4320 lm	100-277 V ~	3 000 K	30000 h	Driver Electrónico	LED Integrado	360°	80	0.7	20	6
RE8056NBCB	Acero	■	48 W	2940 lm	100-240 V ~	3 000 K	30000 h	Driver Electrónico	LED Integrado	180°	80	0.7	20	5.3

RE8123NBCB

LED 28 WATTS 2250 LUMENS 3000K 120° ANGLULO APERTURA IP50 NEGRO



- 10m de cable
- Incluye 3 grapas
- 5 niveles de atenuación

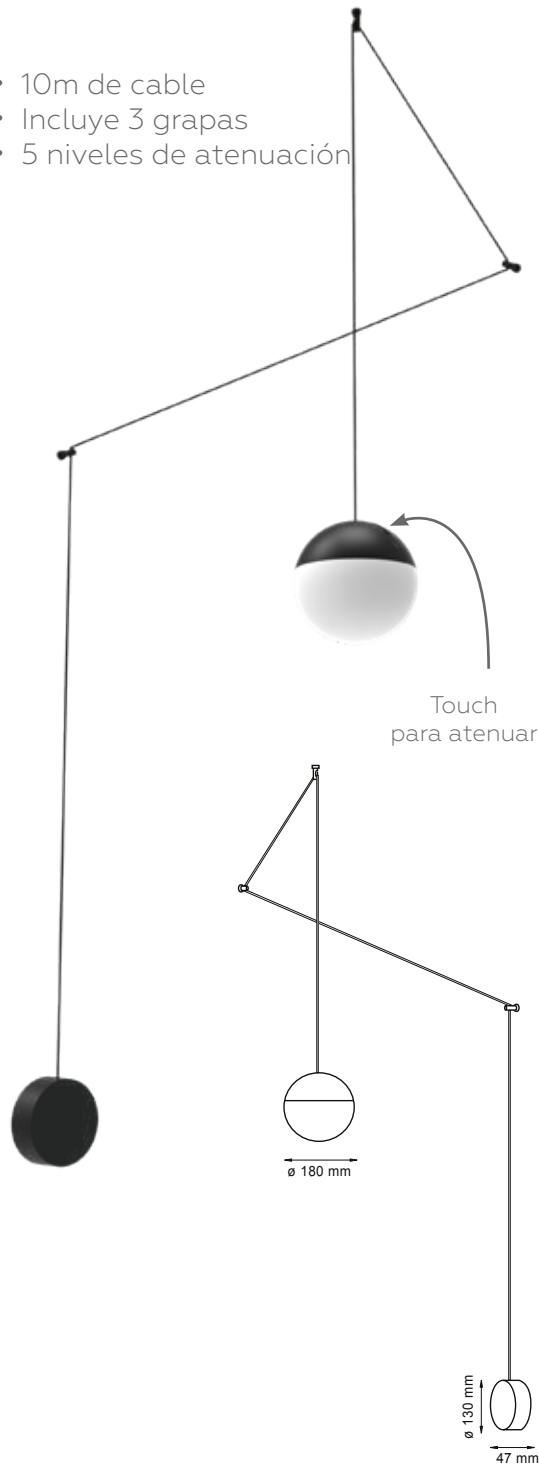

RE8059NBCB

LED 3 WATTS 80 LUMENS 3000K 180° ANGLULO APERTURA IP20 NEGRO

NUEVO



RE8057BBCB

LED 30 WATTS 2100 LUMENS 3000K 180° ANGLULO APERTURA IP20 BLANCO

NUEVO



CÓDIGO	MATERIAL DE CUERPO	COLOR	POTENCIA	FLUJO LUMINOSO	ALIMENTACIÓN	TCC	VIDA ÚTIL (L80)	DRIVER	FUENTE DE LUZ	ÁNGULO DE APERTURA (VxH)	IRC	FP	IP	IK	PESO (KG)
RE8123NBCB	Aluminio	■	28 W	2250 lm	127-220 V	□ 3 000 K	30 000 h	Driver Electrónico	LED Integrado	120°	80	0.8	50	-	2
RE8059NBCB	Acero	■	3 W	80 lm	100-240 V ~	□ 3 000 K	30000 h	Driver Electrónico	LED Integrado	180°	80	0.7	20	0.9	0.9
RE8057BBCB	Aluminio	□	30 W	2100 lm	100-240 V ~	□ 3 000 K	30000 h	Driver Electrónico	LED Integrado	180°	80	0.7	20	-	3.95

RE8020BBCB

LED 28 WATTS 1427 LUMENS 3000K 100° ANGULO APERTURA IP30 BLANCO

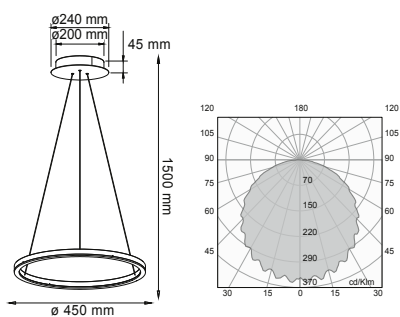

RE8021BBCB

LED 38 WATTS 2055 LUMENS 3000K 100° ANGULO APERTURA IP30 BLANCO

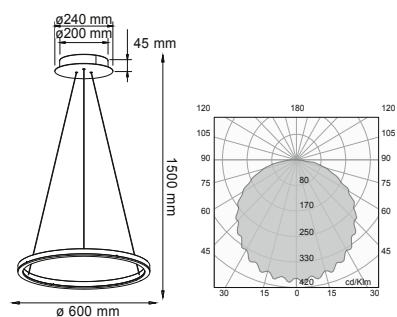

RE8023BBCB

LED 72 WATTS 3263 LUMENS 3000K 110° ANGULO APERTURA IP30 BLANCO

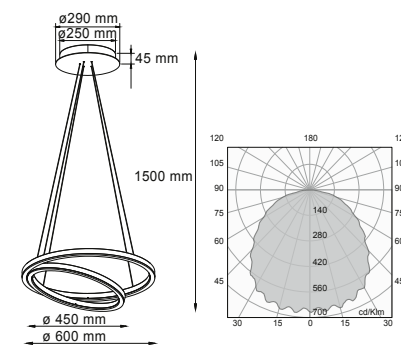

CÓDIGO	MATERIAL DE CUERPO	COLOR	POTENCIA	FLUJO LUMINOSO	ALIMENTACIÓN	TCC	VIDA ÚTIL (L80)	DRIVER	FUENTE DE LUZ	ÁNGULO DE APERTURA (VxH)	IRC	FP	IP	PESO (KG)
RE8020BBCB	Aluminio	□	28 W	1427 lm	127-220 V	3 000 K	25 000 h	Driver electrónico	LED Integrado	100°	85	0.9	30	4.5
RE8021BBCB	Aluminio	□	38 W	2055 lm	127-220 V	3 000 K	25 000 h	Driver electrónico	LED Integrado	100°	85	0.9	30	5.39
RE8023BBCB	Aluminio	□	72 W	3263 lm	127-220 V	3 000 K	25 000 h	Driver electrónico	LED Integrado	110°	85	0.9	30	6.81

RE8024BBCB

LED 110 WATTS 5988 LUMENS 3000K 110° ANGULO APERTURA IP30 BLANCO



DIMMEABLE
0-10 V

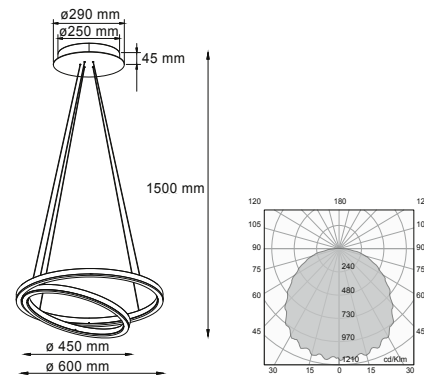

RE8025BBCB

LED 69 WATTS 5540 LUMENS 3000K 170° ANGULO APERTURA IP30 BLANCO



DIMMEABLE
0-10 V

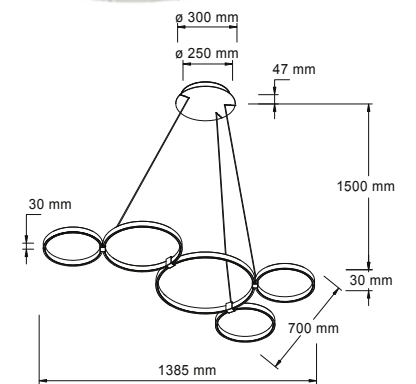

RE8054BBCB

LED 60 WATTS 3600 LUMENS 3000K 180° ANGULO APERTURA IP20 BLANCO

NUEVO

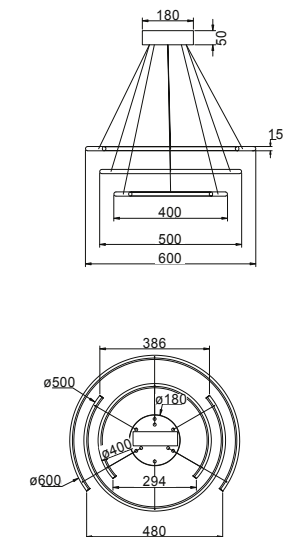

RE8053BBCB

LED 30 WATTS 2400 LUMENS 3000K 180° ANGULO APERTURA IP20 BLANCO

NUEVO

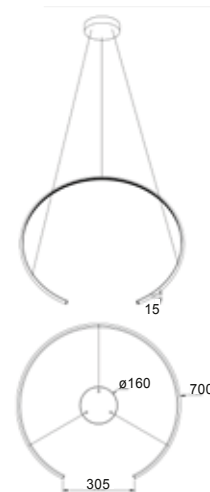

CÓDIGO	MATERIAL DE CUERPO	COLOR	POTENCIA	FLUJO LUMINOSO	ALIMENTACIÓN	TCC	VIDA ÚTIL (L80)	DRIVER	FUENTE DE LUZ	ÁNGULO DE APERTURA (VxH)	IRC	FP	IP	PESO (KG)
RE8024BBCB	Aluminio	<input type="checkbox"/>	110 W	5988 lm	127-220 V	3 000 K	25 000 h	Driver Electrónico	LED Integrado	110°	85	0.95	30	10.89
RE8025BBCB	Aluminio	<input type="checkbox"/>	69 W	5540 lm	127-220 V	3 000 K	25 000 h	Driver Electrónico	LED Integrado	170°	80	0.95	30	4.6
RE8054BBCB	Acero	<input type="checkbox"/>	60 W	3600 lm	100-240 V ~	3 000 K	30 000 h	Driver Electrónico	LED Integrado	180°	80	0.7	20	4.3
RE8053BBCB	Acero	<input type="checkbox"/>	30 W	2400 lm	100-240 V ~	3 000 K	30 000 h	Driver Electrónico	LED Integrado	180°	80	0.7	20	2.3

RE8075BBCB

LED 48 WATTS 1500 LUMENS 3000K 120° ANGULO APERTURA IP30 BLANCO



DIMMABLE 0-10 V

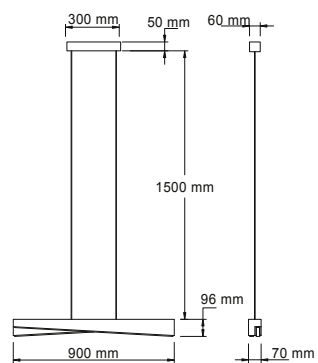

RE8079BBNB

LED 20 WATTS 2700 LUMENS 4000K 350° ANGULO APERTURA IP40 BLANCO

NUEVO

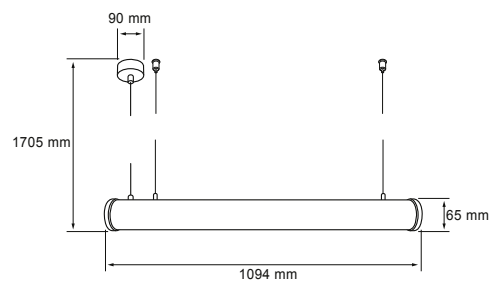

RE8041BBCB

LED 37 WATTS 2245 LUMENS 3000K 90° ANGULO APERTURA IP30 BLANCO



DIMMABLE 0-10 V

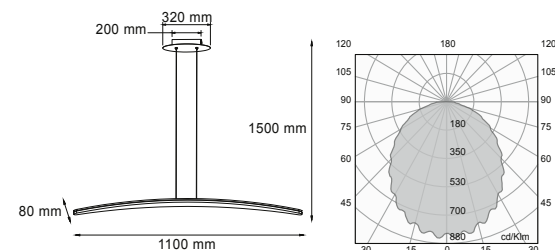

CÓDIGO	MATERIAL DE CUERPO	COLOR	POTENCIA	FLUJO LUMINOSO	ALIMENTACIÓN	TCC	VIDA ÚTIL (L80)	DRIVER	FUENTE DE LUZ	ÁNGULO DE APERTURA (VxH)	IRC	FP	IP	PESO (KG)
RE8075BBCB	Aluminio	<input type="checkbox"/>	48 W	1500 lm	127-220 V	3 000 K	25 000 h	Driver electrónico	LED Integrado	120°	80	0.9	30	6.2
RE8079BBNB	Aluminio	<input type="checkbox"/>	20 W	2700 lm	100-240V ~	4 000 K	30 000 h	Driver electrónico	LED Integrado	350°	90	0.9	40	0.7
RE8041BBCB	Aluminio	<input type="checkbox"/>	37 W	2245 lm	127-220 V	3 000 K	50 000 h	Driver electrónico	LED Integrado	90°	85	0.9	30	3.88

RE8043BBCB



RE8058BBCB



RE8044BBCB

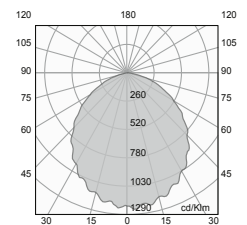
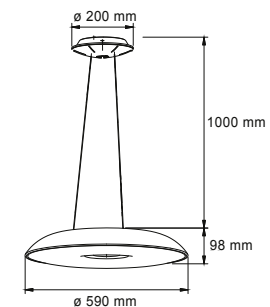
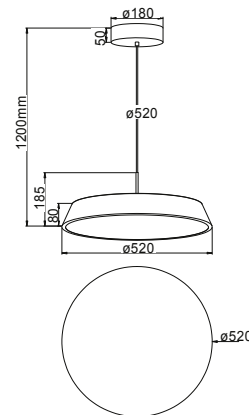
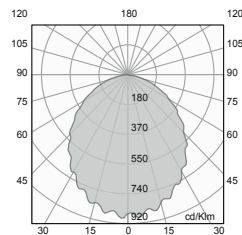
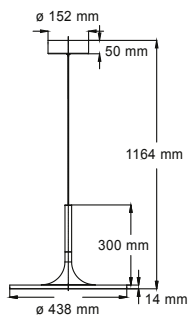
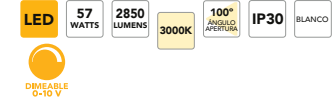

CÓDIGO	MATERIAL DE CUERPO	COLOR	POTENCIA	FLUJO LUMINOSO	ALIMENTACIÓN	TCC	VIDA ÚTIL (L80)	DRIVER	FUENTE DE LUZ	ÁNGULO DE APERTURA (VxH)	IRC	FP	IP	PESO (KG)
RE8043BBCB	Aluminio	<input type="checkbox"/>	34 W	2150 lm	127-220 V	3 000 K	50 000 h	Driver electrónico	LED Integrado	110°	80	0.9	30	5.45
RE8058BBCB	Acero	<input type="checkbox"/>	30 W	2100 lm	100-240 V ~	3 000 K	30000 h	Driver Electrónico	LED Integrado	180°	80	0.7	20	3.9
RE8044BBCB	Aluminio	<input type="checkbox"/>	57 W	2850 lm	127-220 V	3 000 K	50 000 h	Driver electrónico	LED Integrado	100°	85	0.9	30	8.26



RE8051BBCB

LED	49 WATTS	2450 LUMENS	3000K	100° ÁNGULO DE APERTURA	IP30	BLANCO
-----	----------	-------------	-------	----------------------------	------	--------

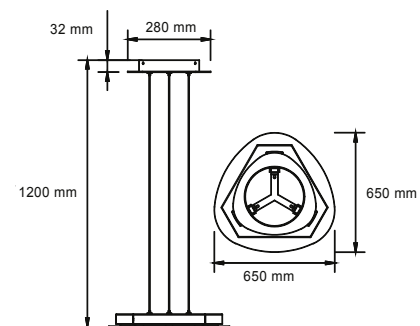
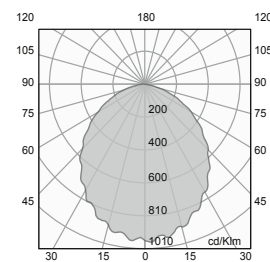

CÓDIGO	MATERIAL DE CUERPO	COLOR	POTENCIA	FLUJO LUMINOSO	ALIMENTACIÓN	TCC	VIDA ÚTIL (L80)	DRIVER	FUENTE DE LUZ	ÁNGULO DE APERTURA (VxH)	IRC	FP	IP	PESO (KG)
RE8051BBCB	Aluminio	□	49 W	2450 lm	127-220 V	3 000 K	50 000 h	Driver electrónico	LED Integrado	100°	85	0.9	30	10.59

RE8060NBCB

LED 32 WATTS 1630 LUMENS 3000K 120° ANGULO APERTURA IP30 NEGRO

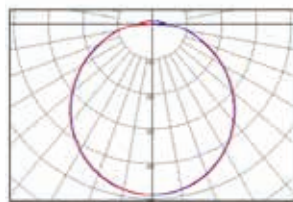
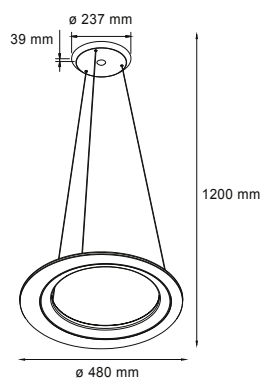
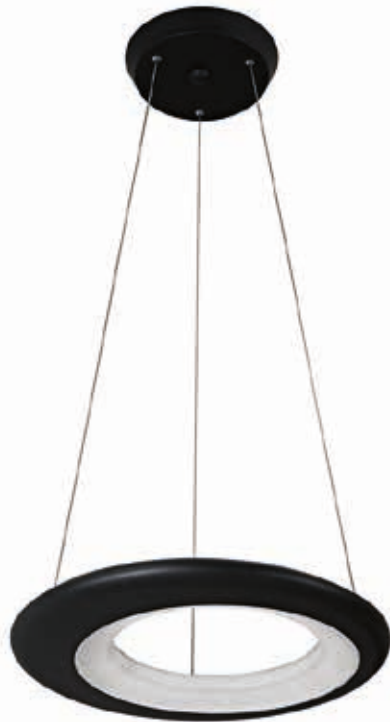

RE8061NBCB

LED 50 WATTS 2700 LUMENS 3000K 140° ANGULO APERTURA IP30 NEGRO

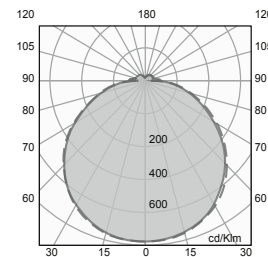
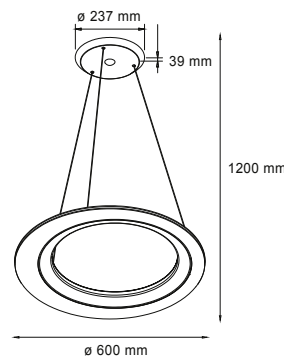

CÓDIGO	MATERIAL DE CUERPO	COLOR	POTENCIA	FLUJO LUMINOSO	ALIMENTACIÓN	TCC	VIDA ÚTIL (L80)	DRIVER	FUENTE DE LUZ	ÁNGULO DE APERTURA (VxH)	IRC	FP	IP	PESO (KG)
RE8060NBCB	Aluminio	■	32 W	1630 lm	127-220 V	3 000 K	50 000 h	Driver electrónico	LED Integrado	120°	85	0.95	30	4.52
RE8061NBCB	Aluminio	■	50 W	2700 lm	127-220 V	3 000 K	50 000 h	Driver electrónico	LED Integrado	140°	85	0.95	30	5.4

RE8118NBCB

LED 24 WATTS 1364 LUMENS 3000K 100° ANGULO APERTURA IP30 NEGRO



DIMMABLE 0-10 V

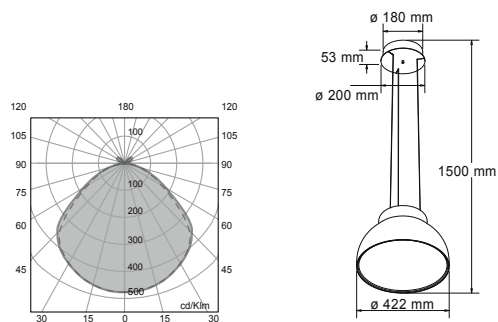

RE8116NBCB

LED 63 WATTS 2300 LUMENS 3000K 120° ANGULO APERTURA IP30 NEGRO



DIMMABLE 0-10 V

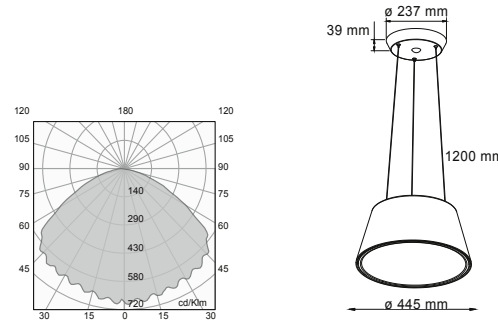
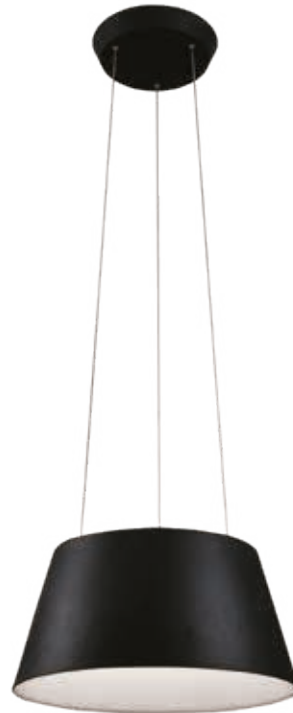

RE8117NBCB

LED 87 WATTS 3000 LUMENS 3000K 120° ANGULO APERTURA IP30 NEGRO



DIMMABLE 0-10 V

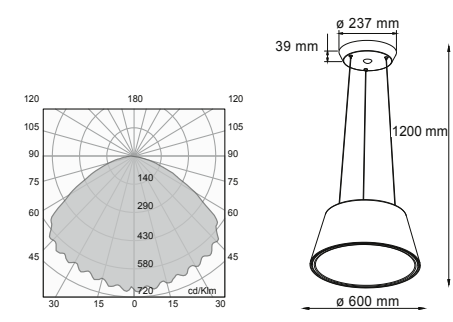
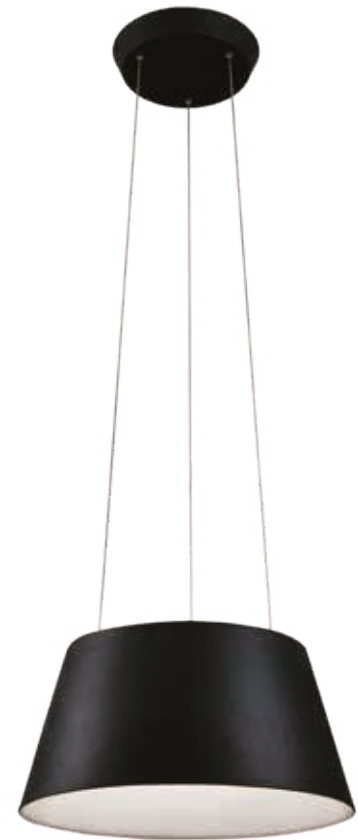

CÓDIGO	MATERIAL DE CUERPO	COLOR	POTENCIA	FLUJO LUMINOSO	ALIMENTACIÓN	TCC	VIDA ÚTIL (L80)	DRIVER	FUENTE DE LUZ	ÁNGULO DE APERTURA (VxH)	IRC	FP	IP	PESO (KG)
RE8118NBCB	Aluminio	■	24 W	1364 lm	127-220 V	3 000 K	50 000 h	Driver electrónico	LED Integrado	100°	80	0.95	30	4.68
RE8116NBCB	Aluminio	■	63 W	2300 lm	127-220 V	3 000 K	50 000 h	Driver electrónico	LED Integrado	120°	85	0.9	30	4.95
RE8117NBCB	Aluminio	■	87 W	3000 lm	127-220 V	3 000 K	50 000 h	Driver electrónico	LED Integrado	120°	85	0.9	30	8

RE8090SBCB

LED 8 WATTS 260 LUMENS 3000K 70° ANGULO APERTURA IP30 SATINADO



RE8096SBCB

LED 80 WATTS 2420 LUMENS 3000K 30° ANGULO APERTURA IP30 SATINADO

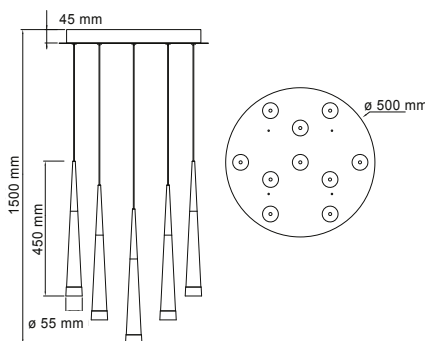
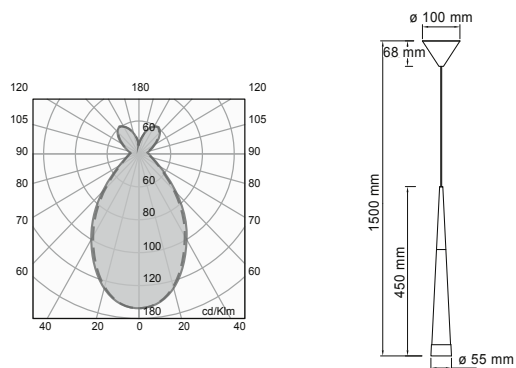
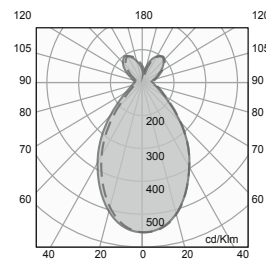
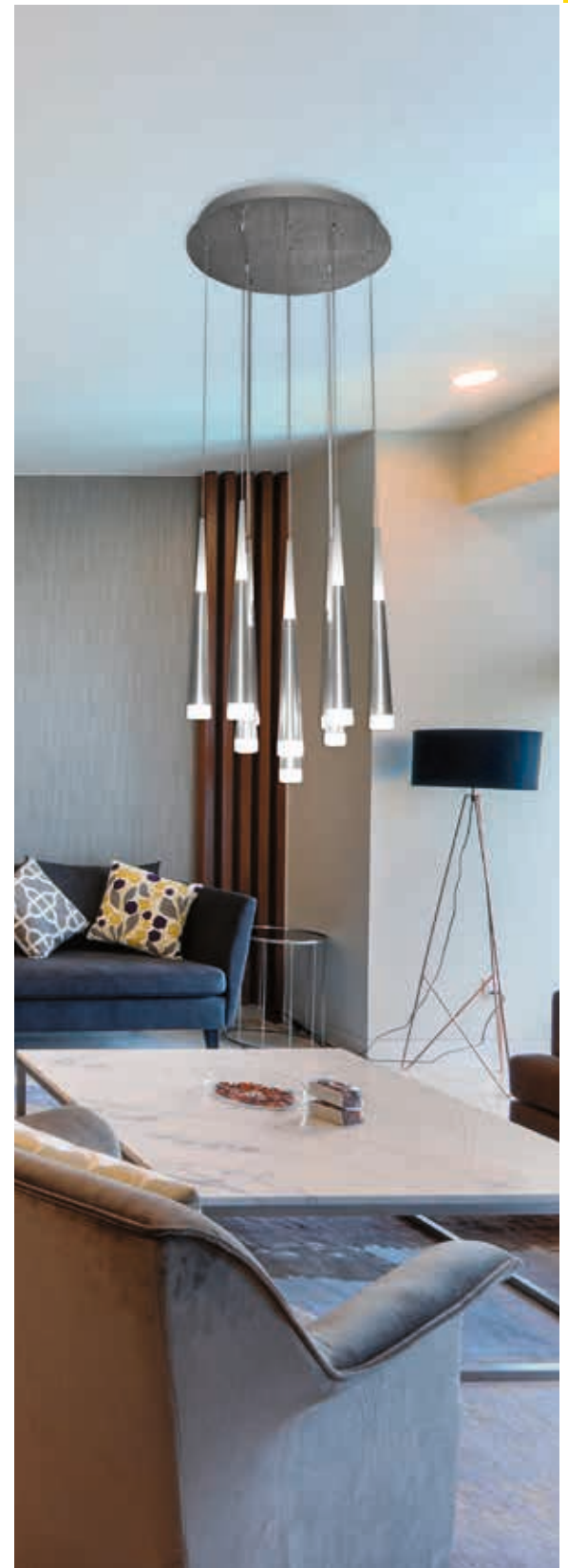

CÓDIGO	MATERIAL DE CUERPO	COLOR	POTENCIA	FLUJO LUMINOSO	ALIMENTACIÓN	TCC	VIDA ÚTIL (L80)	DRIVER	FUENTE DE LUZ	ÁNGULO DE APERTURA (VxH)	IRC	FP	IP	PESO (KG)
RE8090SBCB	Aluminio	■	8 W	260 lm	127-220 V	3 000 K	30 000 h	Driver electrónico	LED Integrado	70°	80	0.9	30	1.7
RE8096SBCB	Aluminio	■	80 W	2420 lm	127-220 V	3 000 K	30 000 h	Driver electrónico	LED Integrado	30°	80	0.9	30	7.32

RE8071BBCB

LED 18 WATTS 1850 LUMENS 3000K 140° ANGULO APERTURA IP30 BLANCO

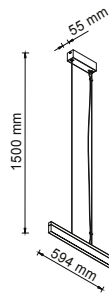
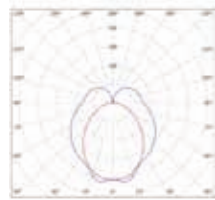
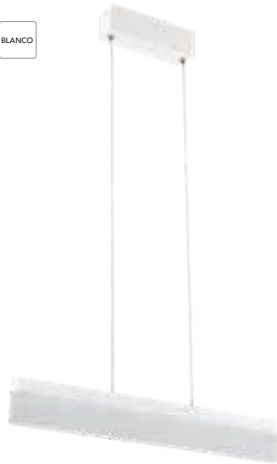

RE8070BBCB

LED 25 WATTS 1200 LUMENS 3000K 60° ANGULO APERTURA IP30 BLANCO

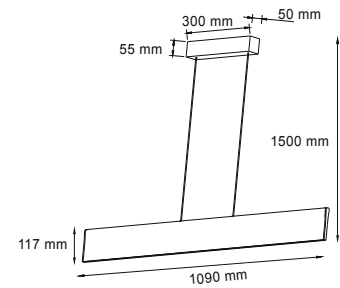
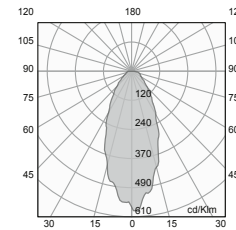

RE8072BBCB

LED 33 WATTS 3000 LUMENS 3000K 140° ANGULO APERTURA IP30 BLANCO

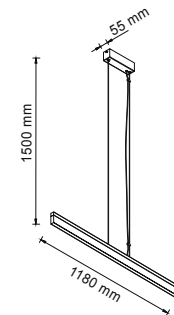
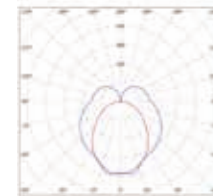

CÓDIGO	MATERIAL DE CUERPO	COLOR	POTENCIA	FLUJO LUMINOSO	ALIMENTACIÓN	TCC	VIDA ÚTIL (L80)	DRIVER	FUENTE DE LUZ	ÁNGULO DE APERTURA (VxH)	IRC	FP	IP	PESO (KG)
RE8071BBCB	Aluminio	<input type="checkbox"/>	18 W	1589 lm	127-220 V	3 000 K	30 000 h	Driver electrónico	LED Integrado	140°	80	0.9	30	4.22
RE8070BBCB	Aluminio	<input type="checkbox"/>	25 W	1200 lm	127-220 V	3 000 K	25 000 h	Driver electrónico	LED Integrado	60°	80	0.9	30	4.4
RE8072BBCB	Aluminio	<input type="checkbox"/>	33 W	3000 lm	127-220 V	3 000 K	30 000 h	Driver electrónico	LED Integrado	140°	80	0.9	30	6.31

RE8076BBCB

LED 24 WATTS 1600 LUMENS 3000K 140° ANGULO APERTURA IP30 BLANCO

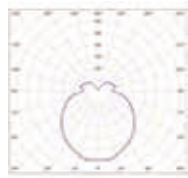
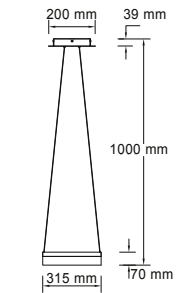

RE8080BBCB

LED 45 WATTS 2188 LUMENS 3000K 60° ANGULO APERTURA IP30 BLANCO

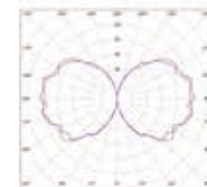
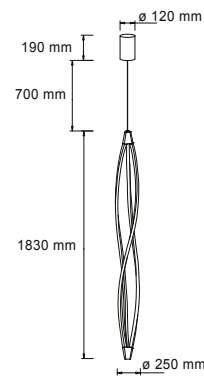

RE8077BBCB

LED 33 WATTS 2600 LUMENS 3000K 140° ANGULO APERTURA IP30 BLANCO

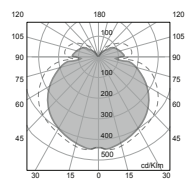
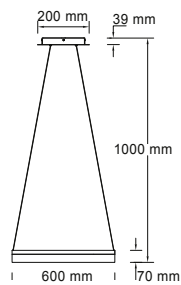

CÓDIGO	MATERIAL DE CUERPO	COLOR	POTENCIA	FLUJO LUMINOSO	ALIMENTACIÓN	TCC	VIDA ÚTIL (L80)	DRIVER	FUENTE DE LUZ	ÁNGULO DE APERTURA (VxH)	IRC	FP	IP	PESO (KG)
RE8076BBCB	Aluminio	<input type="checkbox"/>	24 W	1600 lm	127-220 V	3 000 K	30 000 h	Driver electrónico	LED Integrado	140°	80	0.9	30	4.65
RE8080BBCB	Aluminio	<input type="checkbox"/>	45 W	2188 lm	127-220 V	3 000 K	50 000 h	Driver electrónico	LED Integrado	60°	80	0.95	30	7.29
RE8077BBCB	Aluminio	<input type="checkbox"/>	33 W	2600 lm	127-220 V	3 000 K	30 000 h	Driver electrónico	LED Integrado	140°	80	0.9	30	6.36

RE4060GBCB

LED 48 WATTS 1500 LUMENS 3000K 170° ANGULO APERTURA IP30 GRIS



DIMMEABLE
0-10 V



RE4065GBCB

LED 55 WATTS 2000 LUMENS 3000K 180° ANGULO APERTURA IP30 GRIS



DIMMEABLE
0-10 V

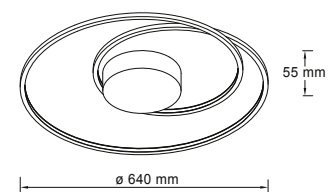
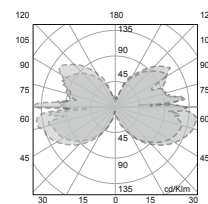
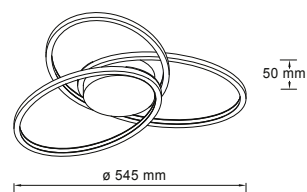
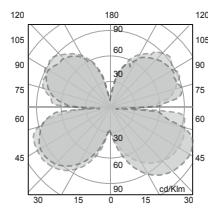

CÓDIGO	MATERIAL DE CUERPO	COLOR	POTENCIA	FLUJO LUMINOSO	ALIMENTACIÓN	TCC	VIDA ÚTIL (L80)	DRIVER	FUENTE DE LUZ	ÁNGULO DE APERTURA (VxH)	IRC	FP	IP	PESO (KG)
RE4060GBCB	Aluminio	■	48 W	1500 lm	127-220 V	■ 3 000 K	30 000 h	Driver Electrónico	LED Integrado	170°	80	0.9	30	3.3
RE4065GBCB	Aluminio	■	55 W	2000 lm	127-220 V	■ 3 000 K	25 000 h	Driver Electrónico	LED Integrado	180°	85	0.9	30	3.76

RE4030BBCB

LED 54 WATTS 2970 LUMENS 3000K 180° ANGLULO APERTURA BLANCO

NUEVO

RE4030NBCB

LED 54 WATTS 2970 LUMENS 3000K 180° ANGLULO APERTURA NEGRO

RE4031BBCB

LED 50 WATTS 3750 LUMENS 3000K 180° ANGLULO APERTURA IP20 BLANCO

NUEVO

RE4031NBCB

LED 50 WATTS 3750 LUMENS 3000K 180° ANGLULO APERTURA IP20 NEGRO

RE4032BBCB

LED 30 WATTS 2100 LUMENS 3000K 180° ANGLULO APERTURA IP20 BLANCO

NUEVO

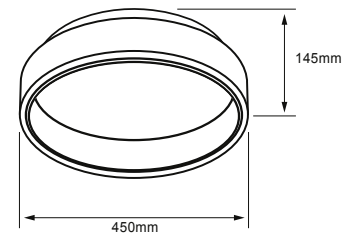
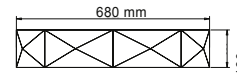
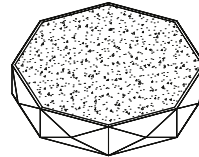
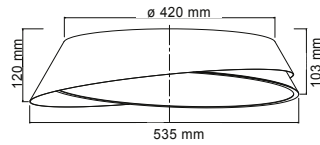

RE4023BBCD

LED 9 WATTS 700 LUMENS 3000K 120° ANGLULO APERTURA IP30 BLANCO

RE4023BBND

LED 9 WATTS 700 LUMENS 4000K 120° ANGLULO APERTURA IP30 BLANCO

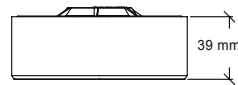
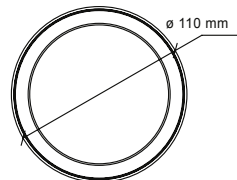
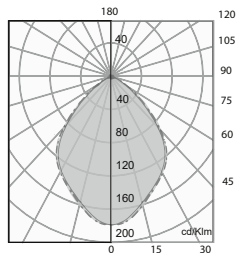

RE4024BBCD

LED 4.5 WATTS 350 LUMENS 3000K 120° ANGLULO APERTURA IP30 BLANCO

RE4024BBND

LED 4.5 WATTS 350 LUMENS 4000K 120° ANGLULO APERTURA IP30 BLANCO

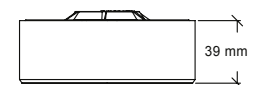
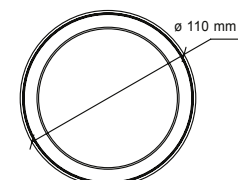
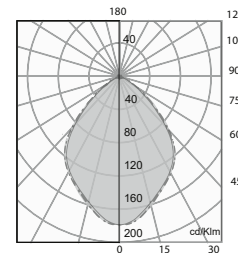

CÓDIGO	MATERIAL DE CUERPO	COLOR	POTENCIA	FLUJO LUMINOSO	ALIMENTACIÓN	TCC	VIDA ÚTIL (L80)	DRIVER	FUENTE DE LUZ	ÁNGULO DE APERTURA (VxH)	IRC	FP	IP	PESO (KG)
RE4030BBCB	Acero/acrilico	□	54 W	2970 lm	100-240 V ~	3 000 K	30000 h	Driver Electrónico	LED Integrado	180°	80	0.9	20	5.36
RE4030NBCB	Acero/acrilico	■	54 W	2970 lm	100-240 V ~	3 000 K	30000 h	Driver Electrónico	LED Integrado	180°	80	0.9	20	5.36
RE4031BBCB	Acero/acrilico	□	50 W	3750 lm	100-240 V ~	3 000 K	30000 h	Driver Electrónico	LED Integrado	180°	80	0.9	20	5.82
RE4031NBCB	Acero/acrilico	■	50 W	3750 lm	100-240 V ~	3 000 K	30000 h	Driver Electrónico	LED Integrado	180°	80	0.9	20	5.82
RE4032BBCB	Acero	□	30 W	2100 lm	100-240 V ~	3 000 K	30000 h	Driver Electrónico	LED Integrado	180°	80	0.7	20	3
RE4023BBCD	Aluminio	□	9 W	700 lm	127 V	3 000 K	50 000 h	Circuito Integrado	LED Integrado	120°	90	0.95	30	0.568
RE4023BBND	Aluminio	□	9 W	700 lm	127 V	4 000 K	50 000 h	Circuito Integrado	LED Integrado	120°	80	0.95	30	0.568
RE4024BBCD	Aluminio	□	4.5 W	350 lm	127 V	3 000 K	50 000 h	Circuito Integrado	LED Integrado	120°	90	0.95	30	0.486
RE4024BBND	Aluminio	□	4.5 W	350 lm	127 V	4 000 K	50 000 h	Circuito Integrado	LED Integrado	120°	80	0.95	30	0.486

RE6077NBCB

LED 4.5 WATTS 230 LUMENS 3000K 120° ANGLULO APERTURA IP20 NEGRO

NUEVO

RE6077DBC

LED 4.5 WATTS 230 LUMENS 3000K 120° ANGLULO APERTURA IP20 DORADO

RE6074BBCB

LED 16 WATTS 1120 LUMENS 3000K 180° ANGLULO APERTURA IP20 BLANCO

NUEVO

RE6073BBCB

LED 16 WATTS 700 LUMENS 3000K 180° ANGLULO APERTURA IP20 BLANCO

NUEVO

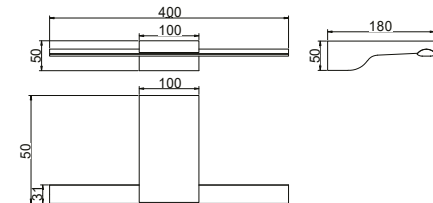
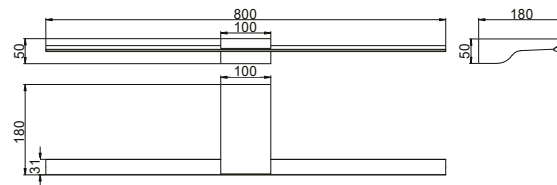
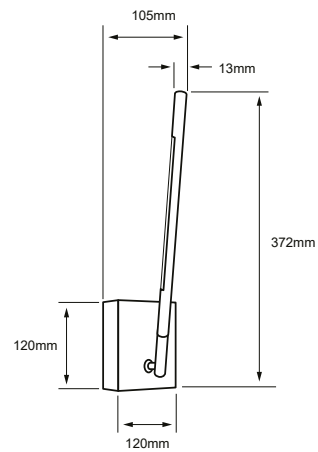

CÓDIGO	MATERIAL DE CUERPO	COLOR	POTENCIA	FLUJO LUMINOSO	ALIMENTACIÓN	TCC	VIDA ÚTIL (L80)	DRIVER	FUENTE DE LUZ	ÁNGULO DE APERTURA (vxH)	IRC	FP	IP	IK	PESO (KG)
RE6077NBCB	Aluminio/Acrílico	■ Negro	4.5 W	230 lm	100-240 V ~	3 000 K	30000 h	Driver Electrónico	LED Integrado	120°	80	0.7	20	-	0.3
RE6077DBC	Aluminio/Acrílico	■ Dorado	4.5 W	230 lm	100-240 V ~	3 000 K	30000 h	Driver Electrónico	LED Integrado	120°	80	0.7	20	-	0.3
RE6074BBCB	Aluminio	□ Blanco	16 W	1120 lm	100-240 V ~	3 000 K	30000 h	Driver Electrónico	LED Integrado	180°	80	0.7	20	-	2.3
RE6073BBCB	Aluminio	□ Blanco	16 W	700 lm	100-240 V ~	3 000 K	30000 h	Driver Electrónico	LED Integrado	180°	80	0.7	20	-	1.1

RE6057BBCB

LED 4 WATTS 244 LUMENS 3000K 109° ANGLULO APERTURA IP20 BLANCO

NUEVO

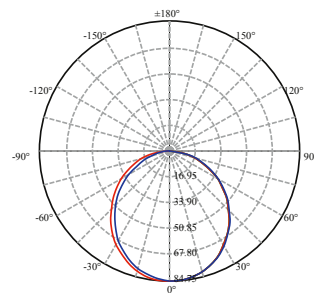
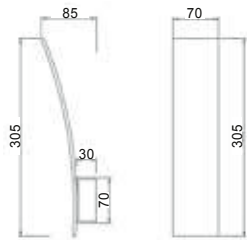

RE6058BBCB

LED 4 WATTS 267 LUMENS 3000K 258° ANGLULO APERTURA IP20 BLANCO

NUEVO

RE6058NBCB

LED 4 WATTS 267 LUMENS 3000K 258° ANGLULO APERTURA IP20 NEGRO

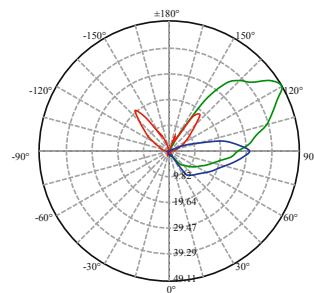
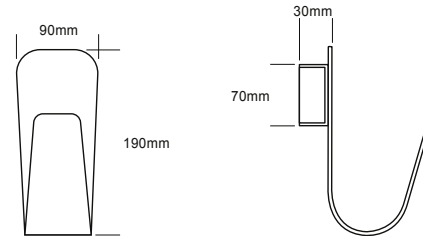

RE6059BBCB

LED 9 WATTS 319 LUMENS 3000K 330° ANGLULO APERTURA BLANCO

NUEVO

RE6059NBCB

LED 9 WATTS 319 LUMENS 3000K 330° ANGLULO APERTURA NEGRO

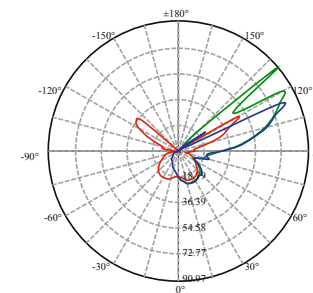
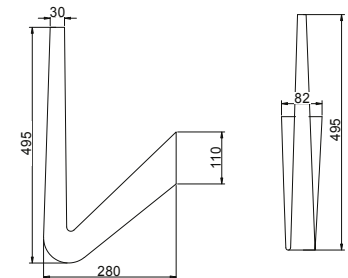

CÓDIGO	MATERIAL DE CUERPO	COLOR	POTENCIA	FLUJO LUMINOSO	ALIMENTACIÓN	TCC	VIDA ÚTIL (L80)	DRIVER	FUENTE DE LUZ	ÁNGULO DE APERTURA (VxH)	IRC	FP	IP	PESO (KG)
RE6057BBCB	Aluminio	□	4 W	244 lm	100-240 V ~	3 000 K	30000 h	Driver Electrónico	LED Integrado	109°	70	0.6	20	0.48
RE6058BBCB	Aluminio	□	4 W	267 lm	100-240 V ~	3 000 K	30000 h	Driver Electrónico	LED Integrado	258°	70	0.6	20	0.38
RE6058NBCB	Aluminio	■	4 W	267 lm	100-240 V ~	3 000 K	30000 h	Driver Electrónico	LED Integrado	258°	70	0.6	20	0.38
RE6059BBCB	Aluminio	□	9 W	319 lm	100-240 V ~	3 000 K	30000 h	Driver Electrónico	LED Integrado	330°	70	0.55	20	1.22
RE6059NBCB	Aluminio	■	9 W	319 lm	100-240 V ~	3 000 K	30000 h	Driver Electrónico	LED Integrado	330°	70	0.55	20	1.22

RE6093SBCB

LED 14 WATTS 840 LUMENS 3000K 100° ANGULO APERTURA IP30 GRIS

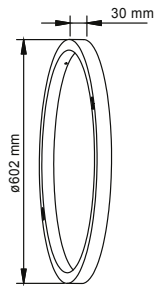
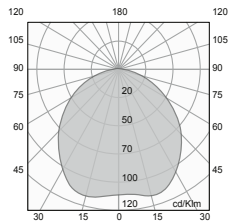

RE6090SBCB

LED 12 WATTS 500 LUMENS 3000K 110° ANGULO APERTURA IP30 GRIS

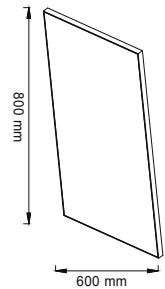
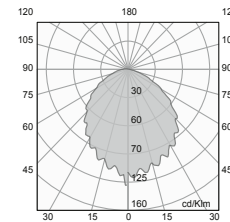

RE6070BBCB

LED 12 WATTS 950 LUMENS 3000K 160° ANGULO APERTURA IP30 BLANCO

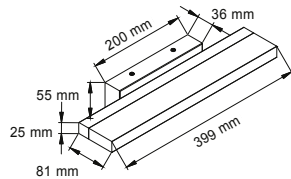
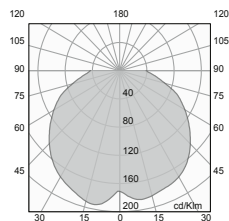

RE6071BBCB

LED 17 WATTS 1500 LUMENS 3000K 160° ANGULO APERTURA IP30 BLANCO

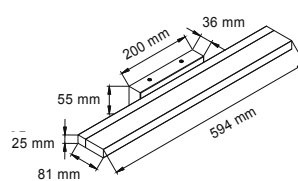
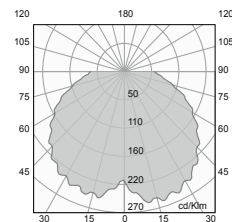

RE6072BBCB

LED 24 WATTS 1850 LUMENS 3000K 160° ANGULO APERTURA IP30 BLANCO

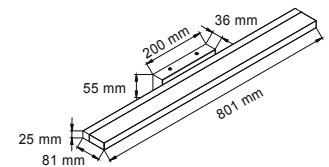
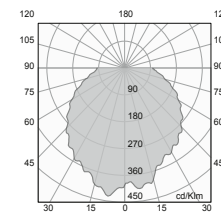

CÓDIGO	MATERIAL DE CUERPO	COLOR	POTENCIA	FLUJO LUMINOSO	ALIMENTACIÓN	TCC	VIDA ÚTIL (L80)	DRIVER	FUENTE DE LUZ	ÁNGULO DE APERTURA (VxH)	IRC	FP	IP	PESO (KG)
RE6093SBCB	Aluminio	■	12 W	500 lm	127-220 V	3 000 K	50 000 h	Driver electrónico	LED Integrado	110°	85	0.35	30	6.46
RE6090SBCB	Aluminio	■	14 W	840 lm	127-220 V	3 000 K	25 000 h	Driver electrónico	LED Integrado	100°	80	0.4	30	10.37
RE6070BBCB	Aluminio	□	12 W	950 lm	127-220 V	3 000 K	25 000 h	Driver electrónico	LED Integrado	160°	80	0.9	30	1.8
RE6071BBCB	Aluminio	□	17 W	1500 lm	127-220 V	3 000 K	25 000 h	Driver electrónico	LED Integrado	160°	80	0.9	30	2.41
RE6072BBCB	Aluminio	□	24 W	1850 lm	127-220 V	3 000 K	25 000 h	Driver electrónico	LED Integrado	160°	85	0.9	30	3.18

RE0001NBCB

LED	4.5 WATTS	230 LUMENS	3000K	120° ANGULO DE APERTURA	IP20	NEGRO
-----	-----------	------------	-------	-------------------------	------	-------

NUEVO

RE0001DBC

LED	4.5 WATTS	230 LUMENS	3000K	120° ANGULO DE APERTURA	IP20	DORADO
-----	-----------	------------	-------	-------------------------	------	--------

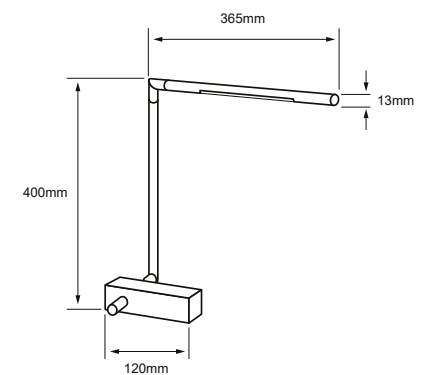

CÓDIGO	MATERIAL DE CUERPO	COLOR	POTENCIA	FLUJO LUMINOSO	ALIMENTACIÓN	TCC	VIDA ÚTIL (L80)	DRIVER	FUENTE DE LUZ	ÁNGULO DE APERTURA (VxH)	IRC	FP	IP	PESO (KG)
RE0001NBCB	Aluminio/Acrílico	■	4.5 W	230 lm	100-240 V ~	□ 3 000 K	30000 h	Driver Electrónico	LED Integrado	120°	80	0.7	20	1.4
RE0001DBC	Aluminio/Acrílico	■	4.5 W	230 lm	100-240 V ~	□ 3 000 K	30000 h	Driver LED	LED Integrado	120°	80	0.7	20	1.4

LINEALES



OF4250BBCA

LED 38 WATTS 4000 LUMENS 3000K 100° ANGLULO APERTURA IP20 BLANCO

NUEVO

OF4250BBNA

LED 38 WATTS 4000 LUMENS 4000K 100° ANGLULO APERTURA IP20 BLANCO

OF4250NBCA

LED 38 WATTS 4000 LUMENS 3000K 100° ANGLULO APERTURA IP20 NEGRO

OF4250NBNA

LED 38 WATTS 4000 LUMENS 4000K 100° ANGLULO APERTURA IP20 NEGRO

*Modulo base funciona para tres formas de aplicación:
Empotrar / Suspender / Sobreponer
*Interconectable
*Fácil instalación

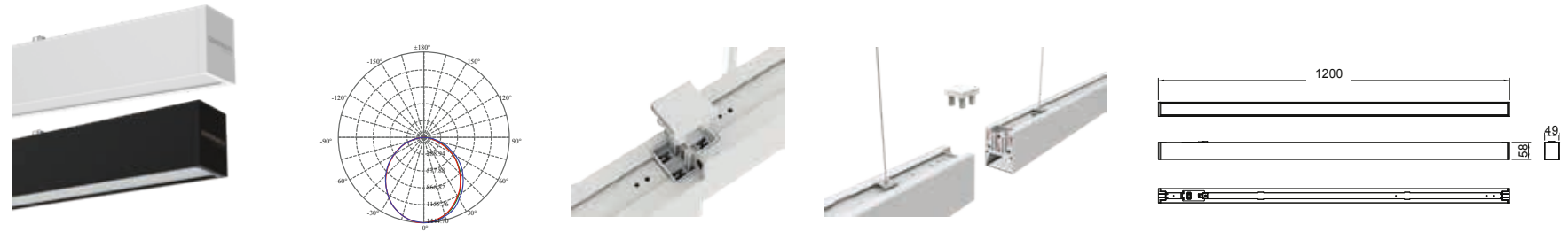

ACCESORIO

AC4251BBCA
AC4251BBNA
AC4251NBCA
AC4251NBNA
Luminario conector en X

NUEVO

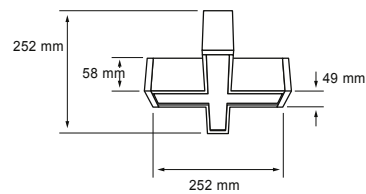

ACCESORIO

AC4252BBCA
AC4252BBNA
AC4252NBCA
AC4252NBNA
Luminario conector en T

NUEVO

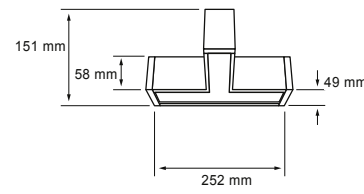

ACCESORIO

AC4253BBCA
AC4253BBNA
AC4253NBCA
AC4253NBNA
Luminario conector en L

NUEVO

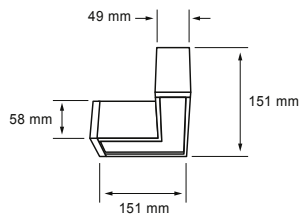

ACCESORIO

AC4256S
Accesorio para sobreponer
*2 piezas

NUEVO

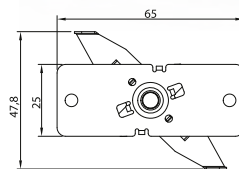

ACCESORIO

AC8254S
Accesorio para suspensión
*2 piezas

NUEVO

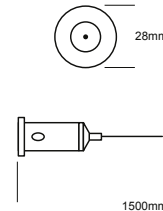

1500mm

ACCESORIO

AC1255S
Accesorio para empotrar
*2 piezas

NUEVO

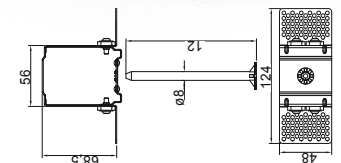

CÓDIGO	MATERIAL DE CUERPO	COLOR	POTENCIA	FLUJO LUMINOSO	ALIMENTACIÓN	TCC	VIDA ÚTIL (L80)	DRIVER	FUENTE DE LUZ	ÁNGULO DE APERTURA (vxH)	IRC	FP	IP	CORTE DE EMPOTRAMIENTO	IK	PESO (KG)
OF4250BBCA	Aluminio / Platico	<input type="checkbox"/>	38 W	4000 lm	100-277 V ~	<input type="checkbox"/> 3 000 K	50000 h	Driver Integrado	LED Integrado	100°	80	0.9	20	1204x53 mm	4	1.76
OF4250BBNA	Aluminio / Platico	<input type="checkbox"/>	38 W	4000 lm	100-277 V ~	<input type="checkbox"/> 4 000 K	50000 h	Driver Integrado	LED Integrado	100°	80	0.9	20	1204x53 mm	4	1.76
OF4250NBCA	Aluminio / Platico	<input checked="" type="checkbox"/>	38 W	4000 lm	100-277 V ~	<input type="checkbox"/> 3 000 K	50000 h	Driver Integrado	LED Integrado	100°	80	0.9	20	1204x53 mm	4	1.76
OF4250NBNA	Aluminio / Platico	<input checked="" type="checkbox"/>	38 W	4000 lm	100-277 V ~	<input type="checkbox"/> 4 000 K	50000 h	Driver Integrado	LED Integrado	100°	80	0.9	20	1204x53 mm	4	1.76

*Sistema lineal de alta versatilidad mediante accesorios de conexión "L", "T", "X"
*Interconexión mecánica y eléctrica en menos de 5 segundos
*Sistema modular preparado para empotrar, sobreponer o suspender (accesorios de venta por separado)
*Línea continua de luz, mimetizando la presencia de juntas en la unión de luminarios

CO811NBNA

LED 40 WATTS 3350 LUMENS 4000K 100° ANGULO APERTURA IP30 NEGRO



NUEVO

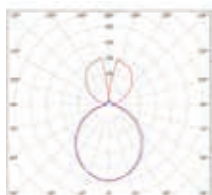
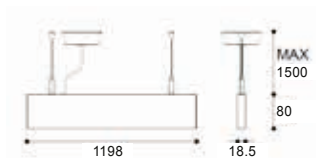

CO8110NBNA

LED 40 WATTS 3200 LUMENS 4000K 100° ANGULO APERTURA IP30 NEGRO



NUEVO

- Sistema de suspensión 1.5m

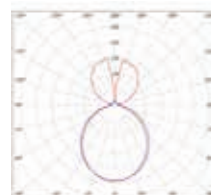
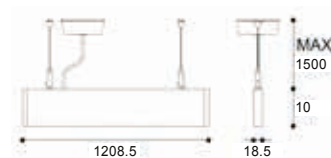

ACCESORIOS

AC8110N

Trazo conector recto para CO811NBNA

AC8111N

Trazo conector 90º para CO811NBNA

CO8095BBNA

LED 58 WATTS 6000 LUMENS 4000K 120° ANGULO APERTURA IP30 BLANCO



- Interconexión mecánica
- Sistema de suspensión 1.5m

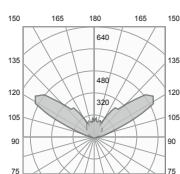

Indirecta

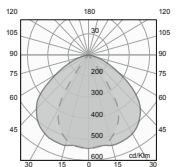

Directa General

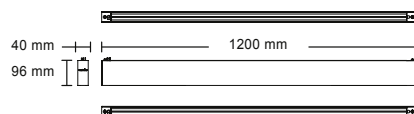

CO8091BBNA

LED 58 WATTS 4700 LUMENS 4000K 60/130° ANGULO APERTURA IP30 BLANCO



CO8091NBNA

LED 58 WATTS 4700 LUMENS 4000K 60/130° ANGULO APERTURA IP30 NEGRO



- Sistema de suspensión 1.5m

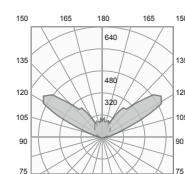

Indirecta

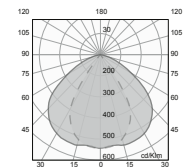

Directa General

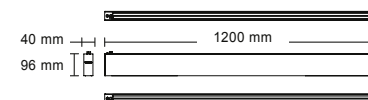

CÓDIGO	MATERIAL DE CUERPO	COLOR	POTENCIA	FLUJO LUMINOSO	ALIMENTACIÓN	TCC	VIDA ÚTIL (L80)	DRIVER	FUENTE DE LUZ	ÁNGULO DE APERTURA (VxH)	IRC	FP	IP	PESO (KG)
CO811NBNA	Aluminio	■	40 W	3350 lm	127-277 V	□ 4 000 K	50 000 h	Driver electrónico	LED Integrado	100°	80	0.9	30	1.5
CO8110NBNA	Aluminio	■	40 W	3200 lm	127-277 V	□ 4 000 K	50 000 h	Driver electrónico	LED Integrado	100°	80	0.9	30	1.5
CO8095BBNA	Aluminio	□	58 W	6000 lm	127-277 V	□ 4 000 K	50 000 h	Driver electrónico	LED Integrado	120°	80	0.9	30	1
CO8091BBNA	Aluminio	□	58 W	4700 lm	127-277 V	□ 4 000 K	50 000 h	Driver electrónico	LED Integrado	60/130°	80	0.9	30	1
CO8091NBNA	Aluminio	■	58 W	4700 lm	127-277 V	□ 4 000 K	50 000 h	Driver electrónico	LED Integrado	60/130°	80	0.9	30	1

CO8102BBNA

LED	115 WATTS	11250 LUMENS	4000K	120° ÁNGULO APERTURA	IP30	BLANCO
-----	-----------	--------------	-------	-------------------------	------	--------

CO8102NBNA

LED	115 WATTS	11250 LUMENS	4000K	120° ÁNGULO APERTURA	IP30	NEGRO
-----	-----------	--------------	-------	-------------------------	------	-------



LUZ DIRECTA E INDIRECTA

• Sistema de suspensión 1.5m

CO8104BBNA

LED	214 WATTS	20970 LUMENS	4000K	120° ÁNGULO APERTURA	IP30	BLANCO
-----	-----------	--------------	-------	-------------------------	------	--------

CO8104NBNA

LED	214 WATTS	20970 LUMENS	4000K	120° ÁNGULO APERTURA	IP30	NEGRO
-----	-----------	--------------	-------	-------------------------	------	-------



DIMENCABLE 0-10 V



LUZ DIRECTA E INDIRECTA

• Sistema de suspensión 1.5m

OF8034BBNA

LED	84 WATTS	7460 LUMENS	4000K	120° ÁNGULO APERTURA	IP30	BLANCO
-----	----------	-------------	-------	-------------------------	------	--------

OF8034GBNA

LED	84 WATTS	7460 LUMENS	4000K	120° ÁNGULO APERTURA	IP30	GRIS
-----	----------	-------------	-------	-------------------------	------	------



LUZ INDIRECTA

• Sistema de suspensión 1.5m

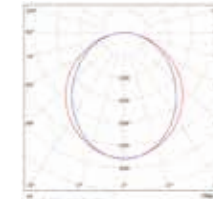
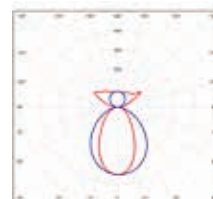
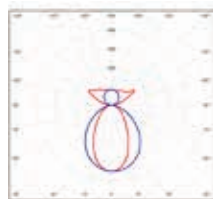
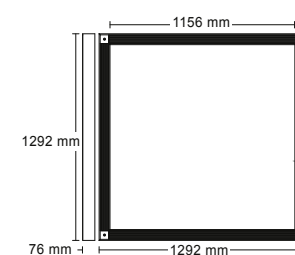
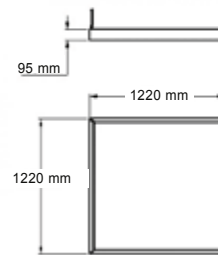
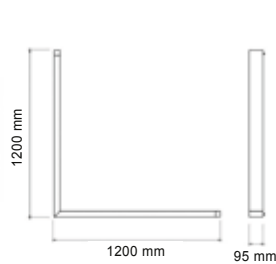

CÓDIGO	MATERIAL DE CUERPO	COLOR	POTENCIA	FLUJO LUMINOSO	ALIMENTACIÓN	TCC	VIDA ÚTIL (L80)	DRIVER	FUENTE DE LUZ	ÁNGULO DE APERTURA (VxH)	IRC	FP	IP	PESO (KG)
CO8102BBNA	Aluminio	□	115 W	11250 lm	127-277 V	□ 4 000 K	50 000 h	Driver electrónico	LED Integrado	120°	80	0.9	30	5.6
CO8102NBNA	Aluminio	■	115 W	11250 lm	127-277 V	□ 4 000 K	50 000 h	Driver electrónico	LED Integrado	120°	80	0.9	30	5.6
CO8104BBNA	Aluminio	□	214 W	20970 lm	127-277 V	□ 4 000 K	50 000 h	Driver electrónico	LED Integrado	120°	80	0.9	30	11.2
CO8104NBNA	Aluminio	■	214 W	20970 lm	127-277 V	□ 4 000 K	50 000 h	Driver electrónico	LED Integrado	120°	80	0.9	30	11.2
OF8034BBNA	Aluminio	□	84 W	7460 lm	127-277 V	□ 4 000 K	50 000 h	Driver electrónico	LED Integrado	120°	80	0.95	30	13
OF8034GBNA	Aluminio	■	84 W	7460 lm	127-277 V	□ 4 000 K	50 000 h	Driver electrónico	LED Integrado	120°	80	0.95	30	13.2

CO8092BBNA

LED 21 WATTS 1530 LUMENS 4000K 130° ANGULO APERTURA IP30 BLANCO

CO8092NBNA

LED 21 WATTS 1530 LUMENS 4000K 130° ANGULO APERTURA IP30 NEGRO



LUZ INDIRECTA

• Sistema de suspensión 1.5m

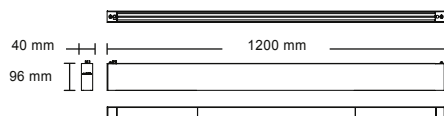
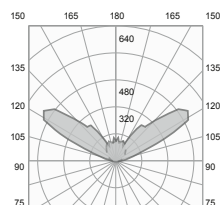

CO8090BCNA

LED 77 WATTS 6310 LUMENS 3000K 90/130° ANGULO APERTURA IP30 BLANCO

CO8090NCNA

LED 77 WATTS 6310 LUMENS 3000K 90/130° ANGULO APERTURA IP30 NEGRO



LUZ ACENTO 30° LUZ INDIRECTA 130°

• Sistema de suspensión 1.5m

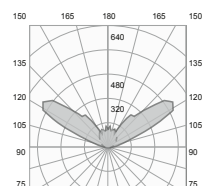

Indirecta

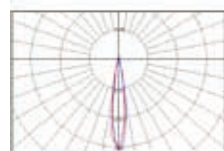

Directa General

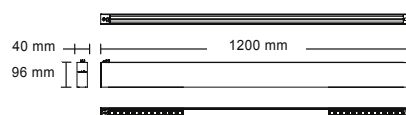

CO8089BCNA

LED 77 WATTS 5030 LUMENS 3000K 10/130° ANGULO APERTURA IP30 BLANCO

CO8089NCNA

LED 77 WATTS 5030 LUMENS 3000K 10/130° ANGULO APERTURA IP30 NEGRO



LUZ ACENTO 30° LUZ INDIRECTA

• Sistema de suspensión 1.5m

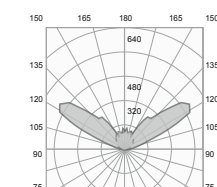

Indirecta

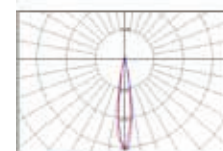

Directa General

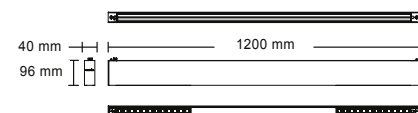

LUMINARIOS RECOMENDADOS



CÓDIGO COLOR
CO5039BBCB
CO5039NBCE



CÓDIGO COLOR
CO5050BBCA
CO5050NBCE
CO5051BBCA
CO5051NBCE
CO5052BBCA
CO5052NBCE



CÓDIGO COLOR
CO5062BBCE
CO5062NBCE



CÓDIGO COLOR
CO5070BBCE
CO5070NBCE
CO5071BBCE
CO5071NBCE



CÓDIGO COLOR
CO5085BBCE
CO5085NBCE



CÓDIGO COLOR
CO5068BBCE
CO5068NBCE



CÓDIGO COLOR
CO5080BBCE
CO5080NBCE



CÓDIGO COLOR
CO5062BBCE
CO5062NBCE



CÓDIGO COLOR
CO5068BBCE
CO5068NBCE

CÓDIGO	MATERIAL DE CUERPO	COLOR	POTENCIA	FLUJO LUMINOSO	ALIMENTACIÓN	TCC	VIDA ÚTIL (L80)	DRIVER	FUENTE DE LUZ	ÁNGULO DE APERTURA (VxH)	IRC	FP	IP	PESO (KG)
CO8092BBNA	Aluminio	<input type="checkbox"/>	21 W	1530 lm	127-277 V	<input type="checkbox"/> 4 000 K	50 000 h	Driver electrónico	LED Integrado	130°	80	0.9	30	1
CO8092NBNA	Aluminio	<input checked="" type="checkbox"/>	21 W	1530 lm	127-277 V	<input type="checkbox"/> 4 000 K	50 000 h	Driver electrónico	LED Integrado	130°	80	0.9	30	1
CO8090BCNA	Aluminio	<input type="checkbox"/>	77 W	6310 lm	127-277 V	<input type="checkbox"/> 3 000 K	50 000 h	Driver electrónico	LED Integrado	30/130°	80	0.9	30	1
CO8090NCNA	Aluminio	<input checked="" type="checkbox"/>	77 W	6310 lm	127-277 V	<input type="checkbox"/> 3 000 K	50 000 h	Driver electrónico	LED Integrado	30/130°	80	0.9	30	1
CO8089BCNA	Aluminio	<input type="checkbox"/>	77 W	5030 lm	127-277 V	<input type="checkbox"/> 3 000 K	50 000 h	Driver electrónico	LED Integrado	10/130°	80	0.9	30	1
CO8089NCNA	Aluminio	<input checked="" type="checkbox"/>	77 W	5030 lm	127-277 V	<input type="checkbox"/> 3 000 K	50 000 h	Driver electrónico	LED Integrado	10/130°	80	0.9	30	1

OF8192BBNA

LED 36 WATTS 3271 LUMENS 4000K 120° ANGLULO APERTURA IP30 BLANCO



- Sistema de suspensión 1.5m
- Al interconectar las luminarias se necesita alimentación individual de cada una

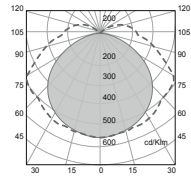
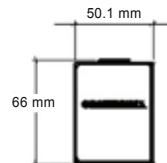
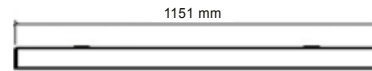

OF8021BBNA

LED 20 WATTS 1734 LUMENS 4000K 120° ANGLULO APERTURA IP30 BLANCO

OF8021NBNA
LED 20 WATTS 1734 LUMENS 4000K 120° ANGLULO APERTURA IP30 NEGRO



- Sistema de suspensión 1.5m

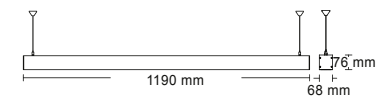
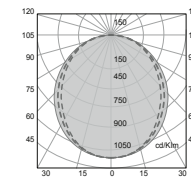

OF8022BBNA

LED 34 WATTS 3271 LUMENS 4000K 120° ANGLULO APERTURA IP30 BLANCO

OF8022BBND

LED 2x16 WATTS 1600 LUMENS 4000K 120° ANGLULO APERTURA IP30 BLANCO

OF8022GBNA

LED 34 WATTS 3271 LUMENS 4000K 120° ANGLULO APERTURA IP30 GRIS

OF8022NBNA

LED 34 WATTS 3271 LUMENS 4000K 120° ANGLULO APERTURA IP30 NEGRO

- Sistema de suspensión 1.5m

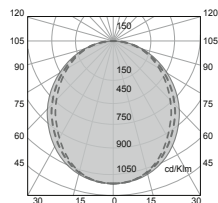
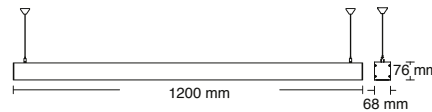

OF8056BBNA

LED 45 WATTS 3890 LUMENS 4000K 120° ANGLULO APERTURA IP30 BLANCO

OF8056GBNA

LED 45 WATTS 3890 LUMENS 4000K 120° ANGLULO APERTURA IP30 GRIS

OF8056NBNA

LED 45 WATTS 3890 LUMENS 4000K 120° ANGLULO APERTURA IP30 NEGRO

- Sistema de suspensión 1.5m

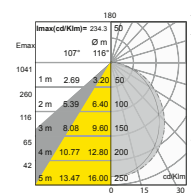
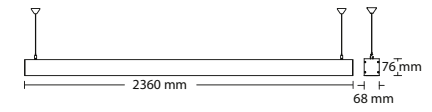

ACCESORIOS

- AC8101BBNA Slim Pro Conector L
- AC8102BBNA Slim Pro Conector X
- AC8103BBNA Cable para suspensión Slim Pro Conector T

CÓDIGO	MATERIAL DE CUERPO	COLOR	POTENCIA	FLUJO LUMINOSO	ALIMENTACIÓN	TCC	VIDA ÚTIL (L80)	DRIVER	FUENTE DE LUZ	ÁNGULO DE APERTURA (VxH)	IRC	FP	IP	PESO (KG)
OF8192BBNA	Aluminio	<input type="checkbox"/>	36 W	3271 lm	127-277 V	<input type="checkbox"/> 4 000 K	50 000 h	Driver electrónico	LED Integrado	120°	80	0.95	30	2.1
OF8021BBNA	Aluminio	<input type="checkbox"/>	20 W	1734 lm	127-277 V	<input type="checkbox"/> 4 000 K	50 000 h	Driver electrónico	LED Integrado	120°	80	0.95	30	3.6
OF8021NBNA	Aluminio	<input checked="" type="checkbox"/>	20 W	1734 lm	127-277 V	<input type="checkbox"/> 4 000 K	50 000 h	Driver electrónico	LED Integrado	120°	80	0.9	30	3.6
OF8022BBNA	Aluminio	<input type="checkbox"/>	36 W	3271 lm	127-277 V	<input type="checkbox"/> 4 000 K	50 000 h	Driver electrónico	LED Integrado	120°	80	0.95	30	3.622
OF8022BBND	Aluminio	<input type="checkbox"/>	2x16 W	1600 lm	127 V	<input type="checkbox"/> 4 000 K	15 000 h	-	T5	120°	80	0.5	30	5.6
OF8022GBNA	Aluminio	<input checked="" type="checkbox"/>	36 W	3271 lm	127-277 V	<input type="checkbox"/> 4 000 K	50 000 h	Driver electrónico	LED Integrado	120°	80	0.95	30	3.622
OF8022NBNA	Aluminio	<input checked="" type="checkbox"/>	36 W	3271 lm	127-277 V	<input type="checkbox"/> 4 000 K	50 000 h	Driver electrónico	LED Integrado	120°	80	0.9	30	3.622
OF8056BBNA	Aluminio	<input type="checkbox"/>	45 W	3890 lm	127-277 V	<input type="checkbox"/> 4 000 K	50 000 h	Driver electrónico	LED Integrado	120°	80	0.95	30	5.6
OF8056GBNA	Aluminio	<input checked="" type="checkbox"/>	45 W	3890 lm	127-277 V	<input type="checkbox"/> 4 000 K	50 000 h	Driver electrónico	LED Integrado	120°	80	0.95	30	5.6
OF8056NBNA	Aluminio	<input checked="" type="checkbox"/>	45 W	3890 lm	127-277 V	<input type="checkbox"/> 4 000 K	50 000 h	Driver electrónico	LED Integrado	120°	80	0.9	30	5.6

CO1091BBNA

LED 39 WATTS 2900 LUMENS 4000K 60° ANGULO APERTURA IP30 BLANCO

CO1091NBNA

LED 39 WATTS 2900 LUMENS 4000K 60° ANGULO APERTURA IP30 NEGRO

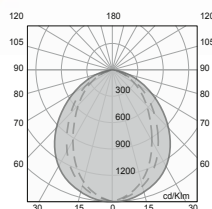
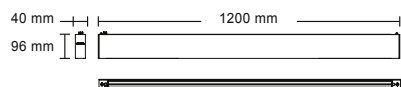

OF1053BBCA

LED 45 WATTS 3890 LUMENS 3000K 120° ANGULO APERTURA IP30 BLANCO

OF1053BBNA

LED 45 WATTS 3890 LUMENS 4000K 120° ANGULO APERTURA IP30 BLANCO

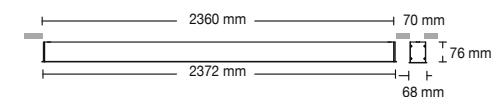
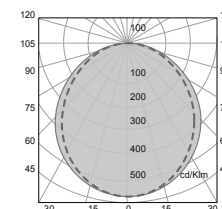

OF1052BBNA

LED 36 WATTS 3271 LUMENS 4000K 120° ANGULO APERTURA IP30 BLANCO

OF1052NBNA

LED 36 WATTS 3271 LUMENS 4000K 120° ANGULO APERTURA IP30 NEGRO

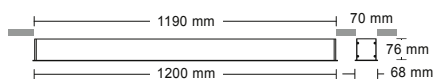
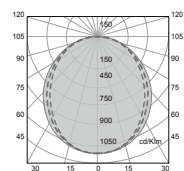
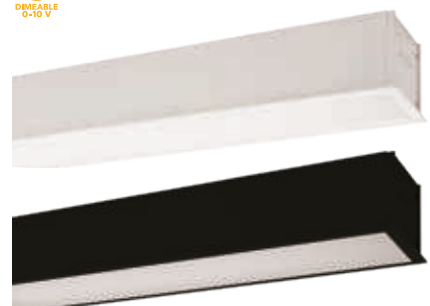

OF4047BBNA

LED 20 WATTS 1734 LUMENS 4000K 120° ANGULO APERTURA IP30 BLANCO

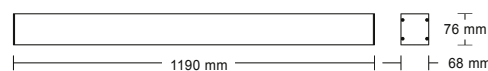
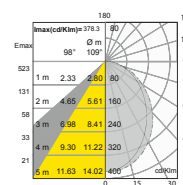

OF4049BBNA

LED 45 WATTS 3890 LUMENS 4000K 120° ANGULO APERTURA IP30 BLANCO

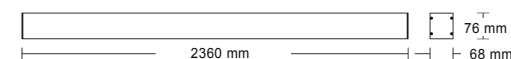
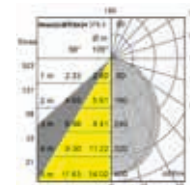

CÓDIGO	MATERIAL DE CUERPO	COLOR	POTENCIA	FLUJO LUMINOSO	ALIMENTACIÓN	TCC	VIDA ÚTIL (L80)	DRIVER	FUENTE DE LUZ	ÁNGULO DE APERTURA (VxH)	IRC	FP	IP	CORTE DE EMPOTRAMIENTO	PESO (KG)
CO1091BBNA	Aluminio	Blanco	39 W	2900 lm	127-277 V	4 000 K	50 000 h	Driver electrónico	LED Integrado	60°	80	0.9	30	1210X47 mm	1
CO1091NBNA	Aluminio	Negro	39 W	2900 lm	127-277 V	4 000 K	50 000 h	Driver electrónico	LED Integrado	60°	80	0.9	30	1210X47 mm	1
OF1053BBCA	Aluminio	Blanco	45 W	3890 lm	127-277 V	3 000 K	50 000 h	Driver electrónico	LED Integrado	120°	80	0.95	30	2362X72 mm	5.6
OF1053BBNA	Aluminio	Blanco	45 W	3890 lm	127-277 V	4 000 K	50 000 h	Driver electrónico	LED Integrado	120°	80	0.95	30	2362X72 mm	5.6
OF1052BBNA	Aluminio	Blanco	36 W	3271 lm	127-277 V	4 000 K	50 000 h	Driver electrónico	LED Integrado	120°	80	0.95	30	1192X70 mm	3
OF1052NBNA	Aluminio	Negro	36 W	3271 lm	127-277 V	4 000 K	50 000 h	Driver electrónico	LED Integrado	120°	80	0.9	30	1192X70 mm	3
OF4047BBNA	Aluminio	Blanco	20 W	1734 lm	127-277 V	4 000 K	50 000 h	Driver electrónico	LED Integrado	120°	80	0.95	30	NA	3.4
OF4049BBNA	Aluminio	Blanco	45 W	3890 lm	127-277 V	4 000 K	50 000 h	Driver electrónico	LED Integrado	120°	80	0.95	30	NA	5.6

OF4206BBCD

LED 12 WATTS 1100 LUMENS 3000K 100° ANGLULO APERTURA IP20 BLANCO

NUEVO

OF4206BBFD

LED 12 WATTS 1100 LUMENS 6500K 100° ANGLULO APERTURA IP20 BLANCO

OF4206BBND

LED 12 WATTS 1100 LUMENS 4000K 100° ANGLULO APERTURA IP20 BLANCO



- Interconectable hasta 8 pzas
- Incluye accesorios para interconexión lineal

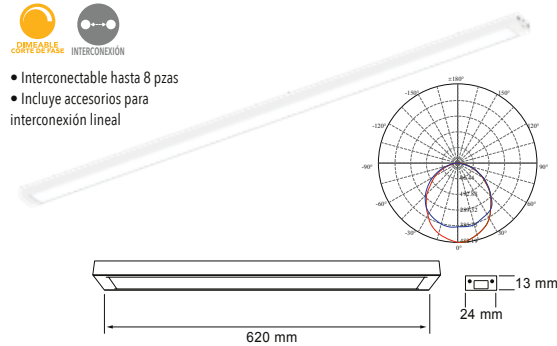

OF4209BBCD

LED 18 WATTS 1600 LUMENS 3000K 100° ANGLULO APERTURA IP20 BLANCO

NUEVO

OF4209BBND

LED 18 WATTS 1600 LUMENS 4000K 100° ANGLULO APERTURA IP20 BLANCO

OF4209BBFD

LED 18 WATTS 1600 LUMENS 6500K 100° ANGLULO APERTURA IP20 BLANCO



- Interconectable hasta 6 pzas
- Incluye accesorios para interconexión lineal

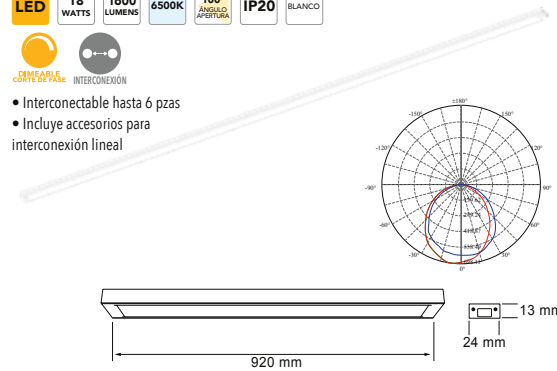

OF4212BBCD

LED 24 WATTS 2200 LUMENS 3000K 100° ANGLULO APERTURA IP20 BLANCO

NUEVO

OF4212BBFD

LED 24 WATTS 2200 LUMENS 6500K 100° ANGLULO APERTURA IP20 BLANCO

OF4212BBND

LED 24 WATTS 2200 LUMENS 4000K 100° ANGLULO APERTURA IP20 BLANCO



- Interconectable hasta 4 pzas
- Incluye accesorios para interconexión lineal

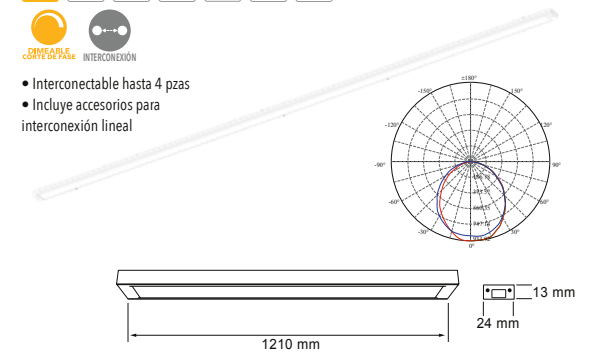

OF4218BBCD

LED 36 WATTS 3200 LUMENS 3000K 100° ANGLULO APERTURA IP20 BLANCO

NUEVO

OF4218BBND

LED 36 WATTS 3200 LUMENS 4000K 100° ANGLULO APERTURA IP20 BLANCO

OF4218BBFD

LED 36 WATTS 3200 LUMENS 6500K 100° ANGLULO APERTURA IP20 BLANCO



- Interconectable hasta 3 pzas
- Incluye accesorios para interconexión lineal



OF4224BBCD

LED 48 WATTS 4400 LUMENS 3000K 100° ANGLULO APERTURA IP20 BLANCO

NUEVO

OF4224BBFD

LED 48 WATTS 4400 LUMENS 6500K 100° ANGLULO APERTURA IP20 BLANCO

OF4224BBND

LED 48 WATTS 4400 LUMENS 4000K 100° ANGLULO APERTURA IP20 BLANCO



- Interconectable hasta 2 pzas
- Incluye accesorios para interconexión lineal

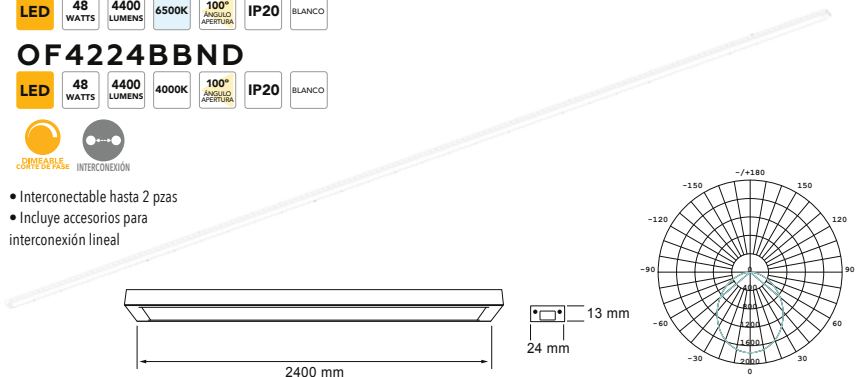

ACCESORIOS
AC6800
Cable acero para suspensión.



AC6801
Conector flexible horizontal.



AC6802
Conector flexible vertical.



AC6803
Conector en L.

CÓDIGO	MATERIAL DE CUERPO	COLOR	POTENCIA	FLUJO LUMINOSO	ALIMENTACIÓN	TCC	VIDA ÚTIL (L80)	DRIVER	FUENTE DE LUZ	ÁNGULO DE APERTURA (VxH)	IRC	FP	IP	IK	PESO (KG)
OF4206BBCD	Aluminio	<input type="checkbox"/>	12 W	1100 lm	127 V ~	3 000 K	30 000 h	Driver electrónico	LED Integrado	100°	80	0.9	20	6	0.14
OF4206BBFD	Aluminio	<input type="checkbox"/>	12 W	1100 lm	127 V ~	6 500 K	30 000 h	Driver electrónico	LED Integrado	100°	80	0.9	20	6	0.14
OF4206BBND	Aluminio	<input type="checkbox"/>	12 W	1100 lm	127 V ~	4 000 K	30 000 h	Driver electrónico	LED Integrado	100°	80	0.9	20	6	0.14
OF4209BBCD	Aluminio	<input type="checkbox"/>	18 W	1600 lm	127 V ~	3 000 K	30 000 h	Driver electrónico	LED Integrado	100°	80	0.9	20	6	0.21
OF4209BBND	Aluminio	<input type="checkbox"/>	18 W	1600 lm	127 V ~	4 000 K	30 000 h	Driver electrónico	LED Integrado	100°	80	0.9	20	6	0.21
OF4209BBFD	Aluminio	<input type="checkbox"/>	18 W	1600 lm	127 V ~	6 500 K	30 000 h	Driver electrónico	LED Integrado	100°	80	0.9	20	6	0.21
OF4212BBCD	Aluminio	<input type="checkbox"/>	24 W	2200 lm	127 V ~	3 000 K	30 000 h	Driver electrónico	LED Integrado	100°	80	0.9	20	6	0.27
OF4212BBFD	Aluminio	<input type="checkbox"/>	24 W	2200 lm	127 V ~	6 500 K	30 000 h	Driver electrónico	LED Integrado	100°	80	0.9	20	6	0.27
OF4212BBND	Aluminio	<input type="checkbox"/>	24 W	2200 lm	127 V ~	4 000 K	30 000 h	Driver electrónico	LED Integrado	100°	80	0.9	20	6	0.27
OF4218BBCD	Aluminio	<input type="checkbox"/>	36 W	3200 lm	127 V ~	3 000 K	30 000 h	Driver electrónico	LED Integrado	100°	80	0.9	20	6	0.4
OF4218BBND	Aluminio	<input type="checkbox"/>	36 W	3200 lm	127 V ~	4 000 K	30 000 h	Driver electrónico	LED Integrado	100°	80	0.9	20	6	0.4
OF4218BBFD	Aluminio	<input type="checkbox"/>	36 W	3200 lm	127 V ~	6 500 K	30 000 h	Driver electrónico	LED Integrado	100°	80	0.9	20	6	0.4
OF4224BBCD	Aluminio	<input type="checkbox"/>	48 W	4400 lm	127 V ~	3 000 K	30 000 h	Driver electrónico	LED Integrado	100°	80	0.9	20	6	0.5
OF4224BBFD	Aluminio	<input type="checkbox"/>	48 W	4400 lm	127 V ~	6 500 K	30 000 h	Driver electrónico	LED Integrado	100°	80	0.9	20	6	0.5
OF4224BBND	Aluminio	<input type="checkbox"/>	48 W	4400 lm	127 V ~	4 000 K	30 000 h	Driver electrónico	LED Integrado	100°	80	0.9	20	6	0.5

CO6091BBNA

LED 55 WATTS 5700 LUMENS 4000K 120° ANGLULO APERTURA IP30 BLANCO

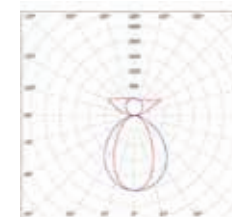
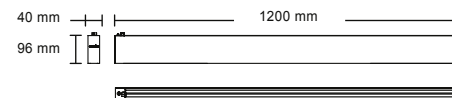

CO4091BBNA

LED 39 WATTS 2900 LUMENS 4000K 60° ANGLULO APERTURA IP30 BLANCO

CO4091NBNA

LED 39 WATTS 2900 LUMENS 4000K 60° ANGLULO APERTURA IP30 NEGRO

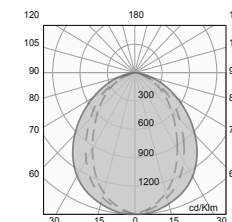
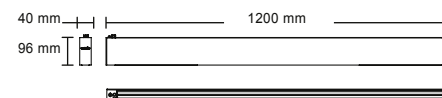

CO4090BBCA

LED 55 WATTS 3250 LUMENS 3000K 30° ANGLULO APERTURA IP30 BLANCO

CO4090NBCA

LED 55 WATTS 3250 LUMENS 3000K 30° ANGLULO APERTURA IP30 NEGRO

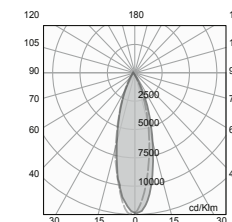
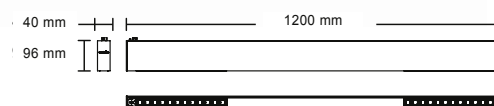

CÓDIGO	MATERIAL DE CUERPO	COLOR	POTENCIA	FLUJO LUMINOSO	ALIMENTACIÓN	TCC	VIDA ÚTIL (L80)	DRIVER	FUENTE DE LUZ	ÁNGULO DE APERTURA (VxH)	IRC	FP	IP	PESO (KG)
CO6091BBNA	Aluminio	□	55 W	5700 lm	127-277 V	□ 4 000 K	50 000 h	Driver electrónico	LED Integrado	120°	80	0.9	30	1
CO4091BBNA	Aluminio	□	39 W	2900 lm	127-277 V	□ 4 000 K	50 000 h	Driver electrónico	LED Integrado	60°	90	0.9	30	1
CO4091NBNA	Aluminio	■	39 W	2900 lm	127-277 V	□ 4 000 K	50 000 h	Driver electrónico	LED Integrado	60°	90	0.9	30	1
CO4090BBCA	Aluminio	□	55 W	3250 lm	127-277 V	■ 3 000 K	50 000 h	Driver electrónico	LED Integrado	30°	90	0.9	30	1
CO4090NBCA	Aluminio	■	55 W	3250 lm	127-277 V	■ 3 000 K	50 000 h	Driver electrónico	LED Integrado	30°	80	0.9	30	1

OF1050BBNA

LED 20 WATTS 1730 LUMENS 4000K 120° ANGLULO APERTURA IP30 BLANCO

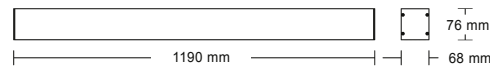
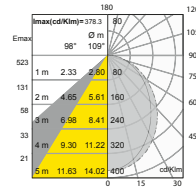

OF4048BBNA

LED 36 WATTS 3271 LUMENS 4000K 120° ANGLULO APERTURA IP30 BLANCO

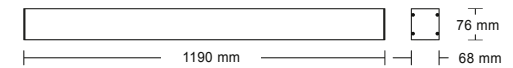
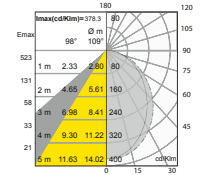

CO4040SBCF

LED 5.5 WATTS 390 LUMENS 2700K 100° ANGLULO APERTURA IP30 SATINADO

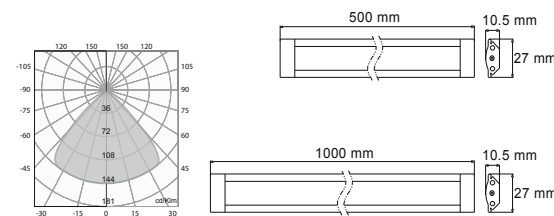

CO4041SBCF

LED 11 WATTS 665 LUMENS 3000K 100° ANGLULO APERTURA IP30 SATINADO

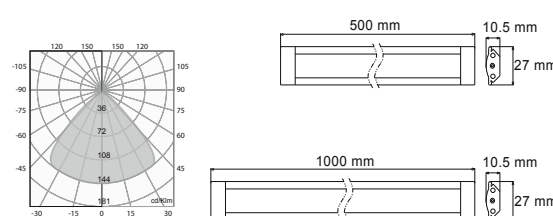

CO4042SBCF

LED 5.5 WATTS 275 LUMENS 3000K 110° ANGLULO APERTURA IP30 SATINADO

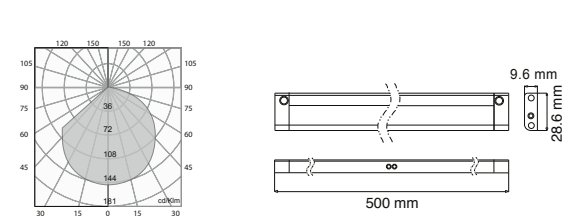

ACCESORIO

AC4040N

Conector recto.

ACCESORIO

AC4041N

Conector en L.

CÓDIGO	MATERIAL DE CUERPO	COLOR	POTENCIA	FLUJO LUMINOSO	ALIMENTACIÓN	TCC	VIDA ÚTIL (L80)	DRIVER	FUENTE DE LUZ	ÁNGULO DE APERTURA (VxH)	IRC	FP	IP	CORTE DE EMPOTRAMIENTO	PESO (KG)
OF1050BBNA	Aluminio	□	20 W	1730 lm	127-277 V	□ 4 000 K	50 000 h	Driver electrónico	LED Integrado	120°	80	0.95	30	1192X70 mm	3.4
OF4048BBNA	Aluminio	□	36 W	3271 lm	127-277 V	□ 4 000 K	50 000 h	Driver electrónico	LED Integrado	120°	80	0.9	30	NA	3.5
OF4048NBNA	Aluminio	■	36 W	3271 lm	127-277 V	□ 4 000 K	50 000 h	Driver electrónico	LED Integrado	120°	80	0.9	30	NA	3.5
CO4040SBCF	Cobre	■	5.5 W	390 lm	12 V	□ 2 700 K	25 000 h	No incluye Driver	LED Integrado	100°	80	-	30	NA	0.17
CO4041SBCF	Cobre	■	11 W	665 lm	12 V	□ 3 000 K	50 000 h	No incluye Driver	LED Integrado	100°	80	-	30	NA	0.188
CO4042SBCF	Cobre	■	5.5 W	275 lm	12 V	□ 3 000 K	25 000 h	No incluye Driver	LED Integrado	110°	80	-	30	NA	0.174



PANEL LED

OF1297BBNA

LED 40 WATTS 4000 LUMENS 4000K 120° ANGLULO APERTURA BLANCO

NUEVO



IN1120BBNA

LED 100 WATTS 10000 LUMENS 4000K 120° ANGLULO APERTURA IP30 BLANCO

IK 6 URG <15

*Pantalla anti deslumbramiento
*Alto flujo



IN1121BBNA

LED 150 WATTS 13000 LUMENS 4000K 120° ANGLULO APERTURA IP30 BLANCO

IK 6 URG <15

*Pantalla anti deslumbramiento
*Alto flujo

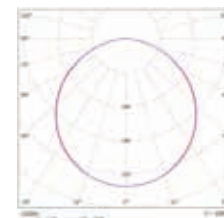
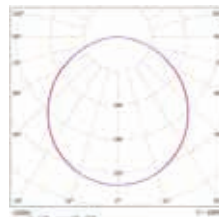
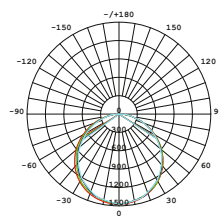
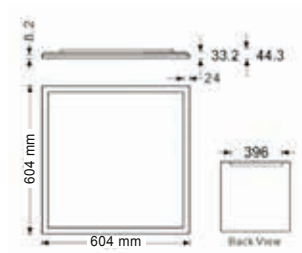
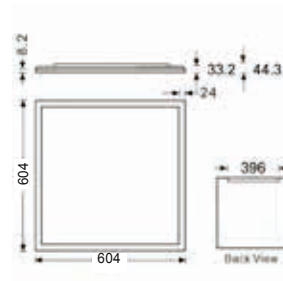
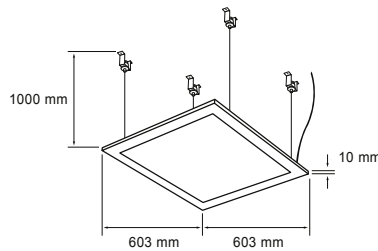
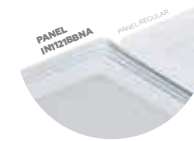

ACCESORIO

AC1097S

Sistema de suspensión 1.5 m longitud

AC1069B

Marco para plafón corrido. Corte a 610mm.

CÓDIGO	MATERIAL DE CUERPO	COLOR	POTENCIA	FLUJO LUMINOSO	ALIMENTACIÓN	TCC	VIDA ÚTIL (L80)	DRIVER	FUENTE DE LUZ	ÁNGULO DE APERTURA (VxH)	IRC	FP	IP	CORTE DE EMPOTRAMIENTO	PESO (KG)
OF1297BBNA	Aluminio	<input type="checkbox"/>	40 W	4000 lm	100-277V ~	<input type="checkbox"/> 4 000 K	30 000 h	Driver electrónico	LED Integrado	120°	80	0.9	NA	590 mm x 590 mm	3.065
IN1120BBNA	Aluminio	<input type="checkbox"/>	100 W	10000 lm	127-277 V	<input type="checkbox"/> 4 000 K	30 000 h	Driver electrónico	LED Integrado	120°	80	0.9	30	NA	3.9
IN1121BBNA	Aluminio	<input type="checkbox"/>	150 W	13000 lm	127-277 V	<input type="checkbox"/> 4 000 K	50 000 h	Driver electrónico	LED Integrado	120°	80	0.9	30	NA	3.9

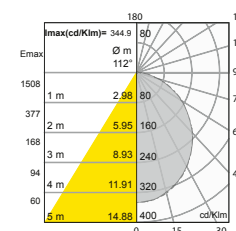
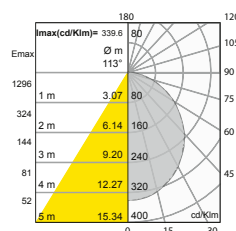
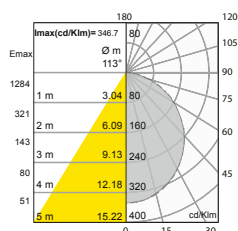
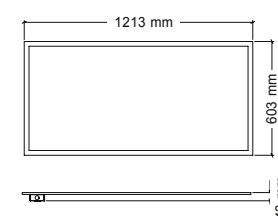
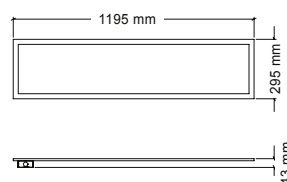
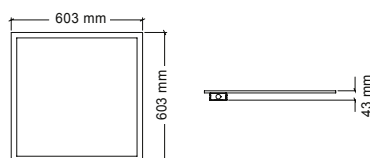
OF1097BCFB**OF1097BBNB****OF1098BBCB****OF1098BBNB****OF1099BBNB****ACCESORIO****AC1097S**

Sistema de suspensión 1.5 m longitud

AC1069B

Marco para plafón corrido. Corte a 610mm.

AC1070B

Marco para plafón corrido. Corte a 1220x305mm.

ACCESORIO**AC1097S**

Sistema de suspensión 1.5 m longitud

CÓDIGO	MATERIAL DE CUERPO	COLOR	POTENCIA	FLUJO LUMINOSO	ALIMENTACIÓN	TCC	VIDA ÚTIL(L80)	DRIVER	FUENTE DE LUZ	ÁNGULO DE APERTURA (VxH)	IRC	FP	IP	CORTE DE EMPOTRAMIENTO	PESO (KG)
OF1097BCFB	Aluminio	<input type="checkbox"/>	40 W	3000 lm	127-220 V	<input type="checkbox"/> AJUSTABLE	30 000 h	Driver electrónico	LED Integrado	120°	80	0.95	30	610X610 mm	3.59
OF1097BBNB	Aluminio	<input type="checkbox"/>	42 W	3000 lm	127-220 V	<input type="checkbox"/> 4 000 K	30 000 h	Driver electrónico	LED Integrado	120°	80	0.9	30	610X610 mm	3.84
OF1098BBCB	Aluminio	<input type="checkbox"/>	40 W	3250 lm	127-220 V	<input type="checkbox"/> 3 000 K	30 000 h	Driver electrónico	LED Integrado	120°	80	0.9	30	1220X305 mm	3.95
OF1098BBNB	Aluminio	<input type="checkbox"/>	42 W	3250 lm	127-220 V	<input type="checkbox"/> 4 000 K	30 000 h	Driver electrónico	LED Integrado	120°	80	0.9	30	1220X305 mm	3.95
OF1099BBNB	Aluminio	<input type="checkbox"/>	60 W	6500 lm	127-220 V	<input type="checkbox"/> 4 000 K	30 000 h	Driver electrónico	LED Integrado	120°	80	0.99	30	1220X610 mm	4.7



GABINETES OFICINA



OF1070BBNA

LED 40 WATTS 3755 LUMENS 4000K 120° ANGLULO APERTURA IP30 BLANCO



DIMMEABLE 0-10 V

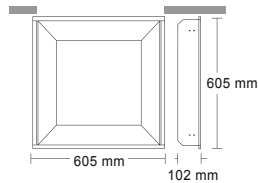
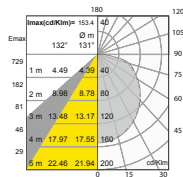

OF1833BBNA

LED 40 WATTS 3350 LUMENS 4000K 120° ANGLULO APERTURA IP30 BLANCO



DIMMEABLE 0-10 V

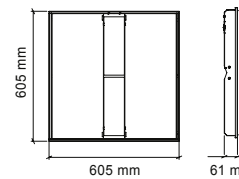
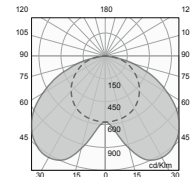

OF1038BBNA

LED 49 WATTS 4750 LUMENS 4000K 120° ANGLULO APERTURA IP30 BLANCO



DIMMEABLE 0-10 V

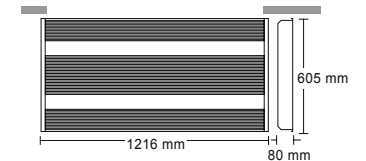
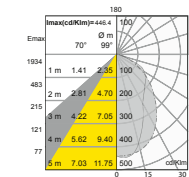

ACCESORIO

AC1069B

Marco para plafón corrido. Corte a 610mm.

ACCESORIO

AC1069B

Marco para plafón corrido. Corte a 610mm.

ACCESORIO

AC1071B

Marco para plafón corrido. Corte a 1220x610mm.

OF1040BBNA

LED 36 WATTS 3200 LUMENS 4000K 120° ANGLULO APERTURA IP30 BLANCO



DIMMEABLE 0-10 V

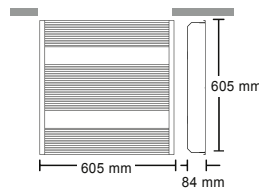
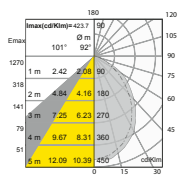

OF1340BBNA

LED 36 WATTS 3200 LUMENS 4000K 120° ANGLULO APERTURA IP30 BLANCO



DIMMEABLE 0-10 V

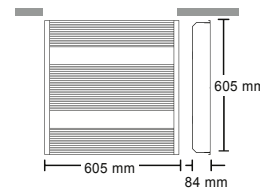
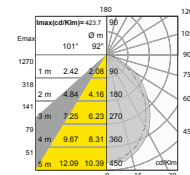

OF1039BBNA

LED 43 WATTS 3900 LUMENS 4000K 120° ANGLULO APERTURA IP30 BLANCO



DIMMEABLE 0-10 V

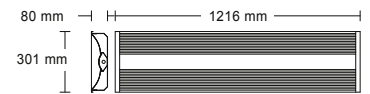
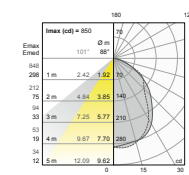

ACCESORIO

AC1070B

Marco para plafón corrido. Corte a 1220x305mm.

ACCESORIO

AC1069B

Marco para plafón corrido. Corte a 610mm.

ACCESORIO

AC1069B

Marco para plafón corrido. Corte a 610mm.

CÓDIGO	MATERIAL DE CUERPO	COLOR	POTENCIA	FLUJO LUMINOSO	ALIMENTACIÓN	TCC	VIDA ÚTIL (L80)	DRIVER	FUENTE DE LUZ	ÁNGULO DE APERTURA (VxH)	IRC	FP	IP	CORTE DE EMPOTRAMIENTO	PESO (KG)
OF1070BBNA	Acero	□	40 W	3755 lm	127-277 V	□ 4 000 K	50 000 h	Driver electrónico	LED Integrado	120°	80	0.9	30	610X610 mm	5.2
OF1833BBNA	Acero	□	40 W	3350 lm	127-277 V	□ 4 000 K	50 000 h	Driver electrónico	LED Integrado	120°	80	0.9	30	610X610 mm	4.5
OF1038BBNA	Acero	□	49 W	4750 lm	127-277 V	□ 4 000 K	50 000 h	Driver electrónico	LED Integrado	120°	80	0.9	30	1220X610 mm	3.5
OF1040BBNA	Acero	□	36 W	3200 lm	127-277 V	□ 4 000 K	25 000 h	Driver electrónico	LED Integrado	120°	80	0.95	30	610X610 mm	5.2
OF1340BBNA	Acero	□	36 W	3200 lm	127-277 V	□ 4 000 K	25 000 h	Driver electrónico	LED Integrado	120°	80	0.95	30	525X440 mm	3
OF1039BBNA	Acero	□	43 W	3900 lm	127-277 V	□ 4 000 K	25 000 h	Driver electrónico	LED Integrado	120°	80	0.9	30	1070X244 mm	3.5

OF1021BBNA

LED 32 WATTS 1795 LUMENS 4000K 120° ANGULO APERTURA IP30 BLANCO



DIMEABLE 0-10 V

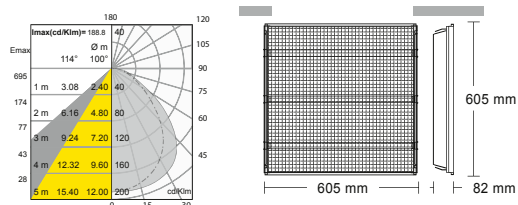

OF1022BBNA

LED 3x10 WATTS 2200 LUMENS 4000K 100° ANGULO APERTURA IP30 BLANCO



DIMEABLE 0-10 V

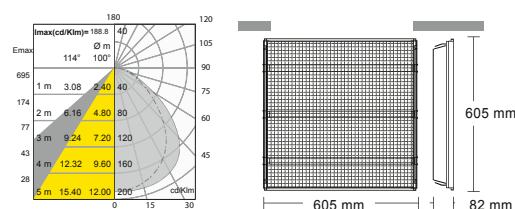

OF1014BBNA

LED 45 WATTS 4500 LUMENS 4000K 100° ANGULO APERTURA IP30 BLANCO



DIMEABLE 0-10 V

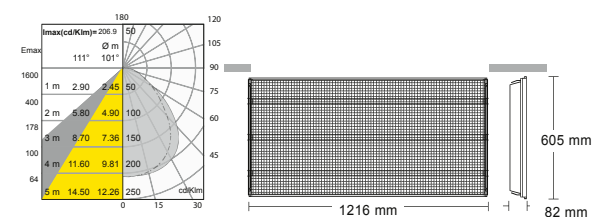

ACCESORIO

AC1071B

Marco para plafón corrido. Corte a 1220x610mm.

OF1321BBNA

LED 37 WATTS 1795 LUMENS 4000K 120° ANGULO APERTURA IP30 BLANCO



DIMEABLE 0-10 V

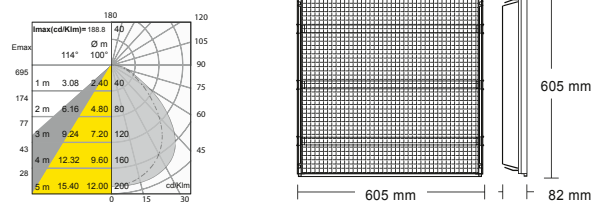

OF1106BBFA

LED 2x18 WATTS 4200 LUMENS 6500K 100° ANGULO APERTURA IP30 BLANCO



DIMEABLE 0-10 V



CÓDIGO	MATERIAL DE CUERPO	COLOR	POTENCIA	FLUJO LUMINOSO	ALIMENTACIÓN	TCC	VIDA ÚTIL (L80)	DRIVER	FUENTE DE LUZ	ÁNGULO DE APERTURA (VxH)	IRC	FP	IP	CORTE DE EMPOTRAMIENTO	PESO (KG)
OF1021BBNA	Acero	□	32 W	1795 lm	127-277 V	□ 4 000 K	50 000 h	Driver electrónico	LED Integrado	120°	80	0.6	30	610X610 mm	5.1
OF1022BBNA	Acero	□	3X10 W	2200 lm	127-277 V	□ 4 000 K	25 000 h	-	T8	100°	80	0.9	30	610X610 mm	5.1
OF1014BBNA	Acero	□	45 W	4500 lm	127-277 V	□ 4 000 K	50 000 h	Driver electrónico	LED Integrado	100°	80	0.99	30	1220X610 mm	7
OF1321BBNA	Acero	□	37 W	1795 lm	127-277 V	□ 4 000 K	50 000 h	Driver electrónico	LED Integrado	120°	80	0.9	30	530X482 mm	6
OF1106BBFA	Acero	□	2X18 W	4200 lm	127-277 V	□ 6 500 K	15 000 h	-	T8	100°	80	0.9	30	1220X305 mm	5.8

OF1106BBFA

LED 2x18 WATTS 4200 LUMENS 6500K 100° ANGLULO APERTURA IP30 BLANCO

NUEVO

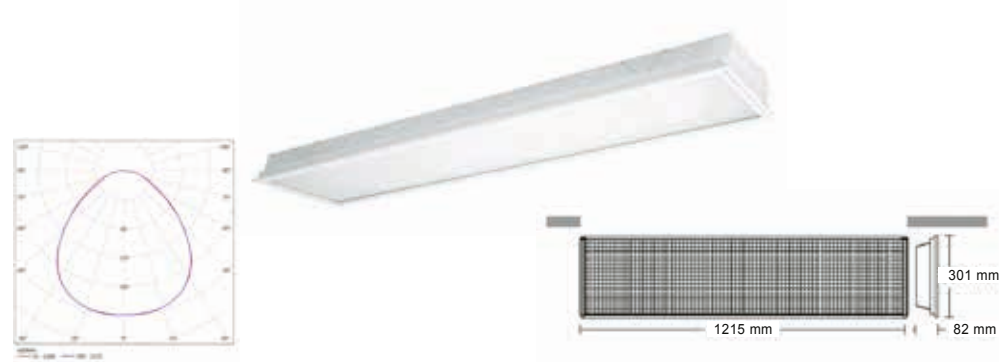

OF1105BBNA

LED 2x18 WATTS 2654 LUMENS 4000K 95° ANGLULO APERTURA IP30 BLANCO

NUEVO



OF1008BBNA

LED 3x10 WATTS 2050 LUMENS 4000K 120° ANGLULO APERTURA IP30 BLANCO

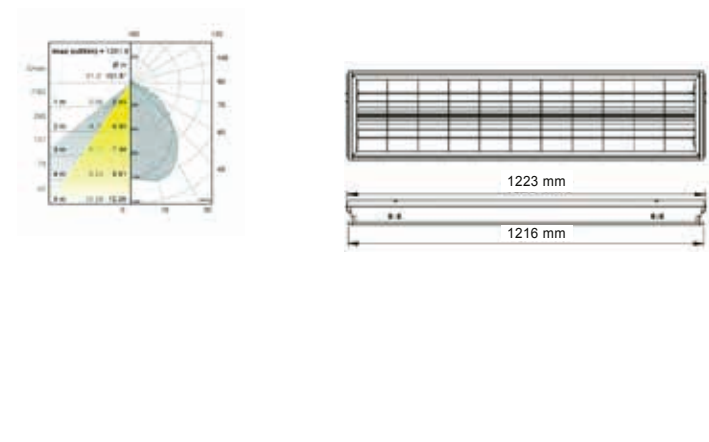

OF1004BBNA

LED 35 WATTS 2675 LUMENS 4000K 120° ANGLULO APERTURA IP30 BLANCO

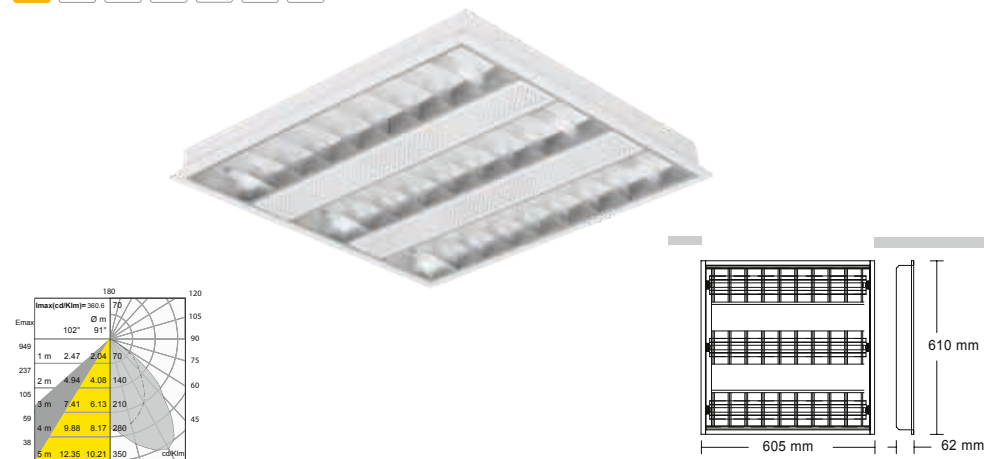

OF4106BBFA

LED 2x18 WATTS 3077 LUMENS 6500K 95° ANGLULO APERTURA IP30 BLANCO

NUEVO



CÓDIGO	MATERIAL DE CUERPO	COLOR	POTENCIA	FLUJO LUMINOSO	ALIMENTACIÓN	TCC	VIDA ÚTIL (L80)	DRIVER	FUENTE DE LUZ	ÁNGULO DE APERTURA (VxH)	IRC	FP	IP	CORTE DE EMPOTRAMIENTO	PESO (KG)
OF1106BBFA	Acero	□	2X18 W	4200 lm	127-277 V	6 500 K	15 000 h	-	T8	100°	80	0.9	30	1220X305 mm	5.8
OF1105BBNA	Acero	□	2X18 W	2654 lm	127-277 V	4 000 K	15 000 h	-	T8	95°	80	0.9	30	1216X301 mm	5.2
OF1008BBNA	Acero	□	3X10 W	2050 lm	127-277 V	4 000 K	25 000 h	-	T8	120°	80	0.95	30	530X484 mm	4.8
OF1004BBNA	Acero	□	35 W	2675 lm	127-277 V	4 000 K	50 000 h	Driver electrónico	LED Integrado	120°	80	0.95	30	530X484 mm	4.6
OF4106BBFA	Acero	□	2X18 W	3077 lm	127-277 V	6 500 K	15 000 h	-	T8	95°	80	0.9	30	NA	6.2

*Construlita se reserva el derecho de modificar la información sin previo aviso y no se hace responsable por errores u omisiones en este documento.

TIRA LED



RE6036AMG

LED 72 WATTS 7400 LUMENS 1800K 120° ANGLULO APERTURA IP20 BLANCO

NUEVO

RE6036BCG1

LED 72 WATTS 7400 LUMENS 2700K 120° ANGLULO APERTURA IP20 BLANCO

RE6036BFG

LED 72 WATTS 7900 LUMENS 6500K 120° ANGLULO APERTURA IP20 BLANCO

RE6036BNG

LED 72 WATTS 7780 LUMENS 4000K 120° ANGLULO APERTURA IP20 BLANCO

70 LEDS / METRO DIMEABLE CORTE DE FASE VIA DRIVER

*Requiere driver.
*Incluye plug de alimentación
*14.4 W/m
*1480-1580 lm/m
*Corte cada 7 LED's

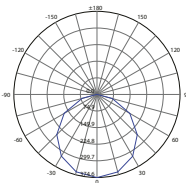
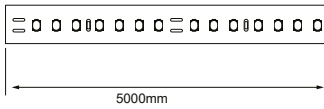

RE6037BCG

LED 96 WATTS 6700 LUMENS 2700K 120° ANGLULO APERTURA IP20 BLANCO

NUEVO

RE6037BFG

LED 96 WATTS 7300 LUMENS 6500K 120° ANGLULO APERTURA IP20 BLANCO

RE6037BNG

LED 96 WATTS 7150 LUMENS 4000K 120° ANGLULO APERTURA IP20 BLANCO

240 LEDS / METRO DIMEABLE CORTE DE FASE VIA DRIVER

*Requiere driver.
*Incluye plug de alimentación
*19.2 W/m
*1340-1460 lm/m
*Corte cada 6 LED's

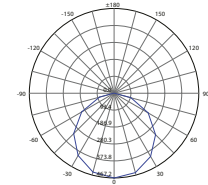
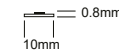
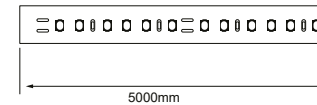

RE6038BCG

LED 120 WATTS 10440 LUMENS 2700K 120° ANGLULO APERTURA IP20 BLANCO

NUEVO

RE6038BFG

LED 120 WATTS 11760 LUMENS 6500K 120° ANGLULO APERTURA IP20 BLANCO

RE6038BNG

LED 120 WATTS 10440 LUMENS 4000K 120° ANGLULO APERTURA IP20 BLANCO

700 LEDS / METRO DIMEABLE CORTE DE FASE VIA DRIVER

*Requiere driver.
*Incluye plug de alimentación
*24 W/m
*2088-2352 lm/m
*Corte cada 7 LED's

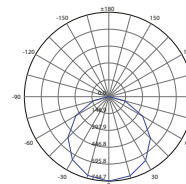
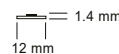
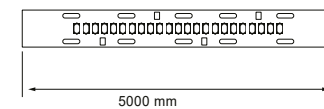

RE6039AMG

LED 96 WATTS 6000 LUMENS 1800K 120° ANGLULO APERTURA IP66 BLANCO

NUEVO

RE6039BCG

LED 96 WATTS 8150 LUMENS 2700K 120° ANGLULO APERTURA IP66 BLANCO

RE6039BFG

LED 96 WATTS 9400 LUMENS 6500K 120° ANGLULO APERTURA IP66 BLANCO

120 LEDS / METRO DIMEABLE CORTE DE FASE VIA DRIVER

*Requiere driver.
*Incluye plug de alimentación
*19.2 W/m
*1200-1630 lm/m
*Corte cada 6 LED's

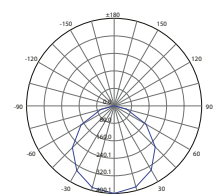
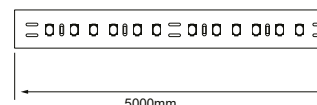

CÓDIGO	MATERIAL DE CUERPO	COLOR	POTENCIA	FLUJO LUMINOSO	ALIMENTACIÓN	TCC	VIDA ÚTIL (L80)	FUENTE DE LUZ	ÁNGULO DE APERTURA (VxH)	IRC	IP	PESO (KG)
RE6036AMG	Aluminio / PCB		72 W	7400 lm	24 VDC	1 800 K	30 000 h	LED Integrado	120°	80	20	0.15
RE6036BCG	Aluminio / PCB		72 W	7400 lm	24 VDC	2 700 K	30 000 h	LED Integrado	120°	80	20	0.15
RE6036BFG	Aluminio / PCB		72 W	7900 lm	24 VDC	6 500 K	30 000 h	LED Integrado	120°	80	20	0.15
RE6036BNG	Aluminio / PCB		72 W	7780 lm	24 VDC	4 000 K	30 000 h	LED Integrado	120°	80	20	0.15
RE6037BCG	Aluminio / PCB		96 W	6700 lm	24 VDC	2 700 K	30 000 h	LED Integrado	120°	90	20	0.16
RE6037BFG	Aluminio / PCB		96 W	7300 lm	24 VDC	6 500 K	30 000 h	LED Integrado	120°	90	20	0.16
RE6037BNG	Aluminio / PCB		96 W	7150 lm	24 VDC	4 000 K	30 000 h	LED Integrado	120°	90	20	0.16
RE6038BCG	Aluminio / PCB		120 W	10440 lm	24 VDC	2 700 K	30 000 h	LED Integrado	120°	90	20	0.17
RE6038BFG	Aluminio / PCB		120 W	11760 lm	24 VDC	6 500 K	30 000 h	LED Integrado	120°	90	20	0.17
RE6038BNG	Aluminio / PCB		120 W	10440 lm	24 VDC	4 000 K	30 000 h	LED Integrado	120°	90	20	0.17
RE6039AMG	Aluminio / PCB / Silicon		96 W	6000 lm	24 VDC	1 800 K	30 000 h	LED Integrado	120°	80	66	0.37
RE6039BCG	Aluminio / PCB / Silicon		96 W	8150 lm	24 VDC	2 700 K	30 000 h	LED Integrado	120°	80	66	0.37
RE6039BFG	Aluminio / PCB / Silicon		96 W	9400 lm	24 VDC	6 500 K	30 000 h	LED Integrado	120°	80	66	0.37

NUEVOS PERFILES PARA TIRAS LED

MATERIAL
ALUMINIO

COLOR
SATINADO

DIFUSOR
PC

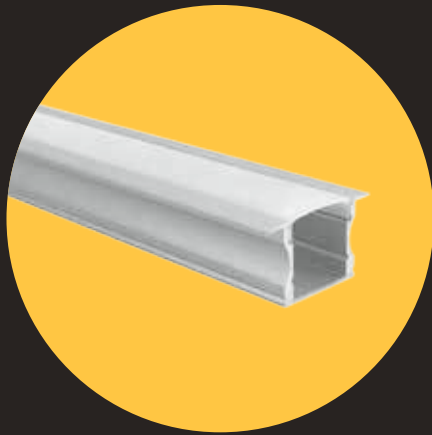

AC2200S

Perfil marcos y pared.
Empotrar.
Alto: 15mm Ancho: 25mm
Longitud: 3000 mm

AC2201

SE VENDE POR SEPARADO



Satinado / Plastico
Aluminio

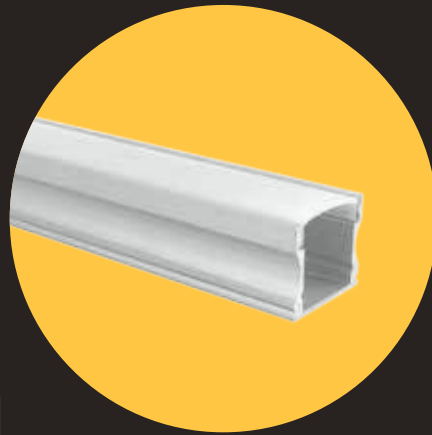

AC6200S

Perfil gabinetes.
Sobreponer.
Alto: 15mm Ancho: 17mm
Longitud: 3000 mm

AC6201

SE VENDE POR SEPARADO



Satinado / Plastico
Aluminio



AC6210S

Perfil luz lineal.
Esquinero sobreponer.
Alto: 18mm Ancho: 18mm
Longitud: 3000 mm

AC6211

SE VENDE POR SEPARADO



Satinado / Plastico
Aluminio

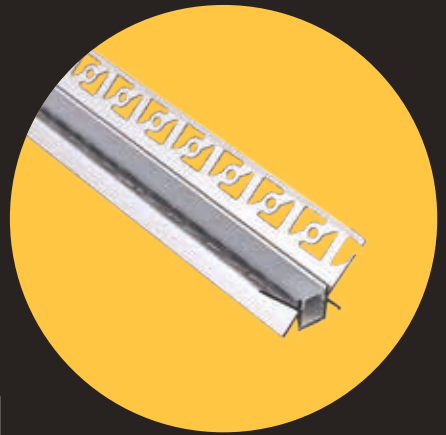

AC3210S

Perfil esquinas internas.
Empotrar.
Alto: 25mm Ancho: 48mm
Longitud: 3000 mm

AC3209

SE VENDE POR SEPARADO



Satinado / Plastico
Aluminio



AC6036

Grapa para instalación
tira LED Int

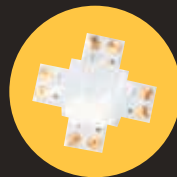

AC6037B

Conector X Interior
(cortable) PI / PI



AC6038N

Conector Multiple
8 Canales tira Driver



AC6039

Conector I

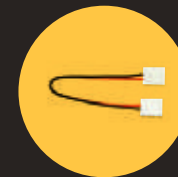

AC6040

Extensión
Conector I

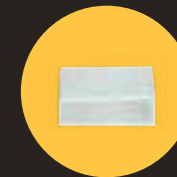

AC6042B

Tapa final
Exterior



AC6043

Conector I Exterior
IP 66

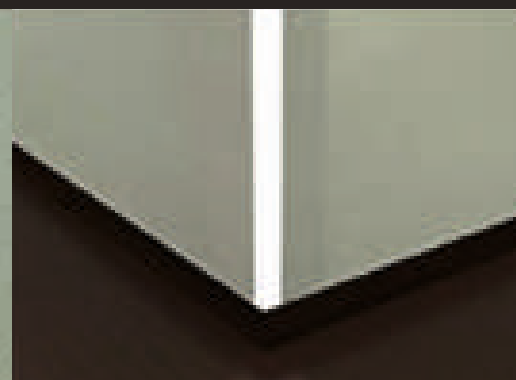
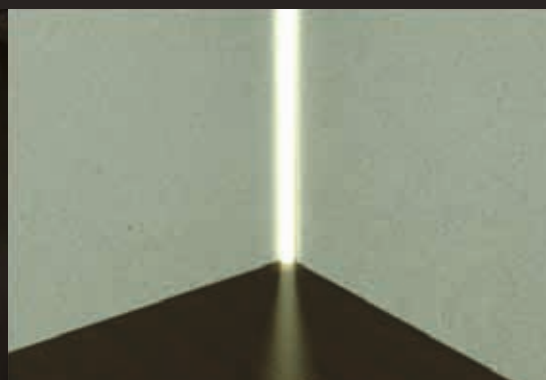
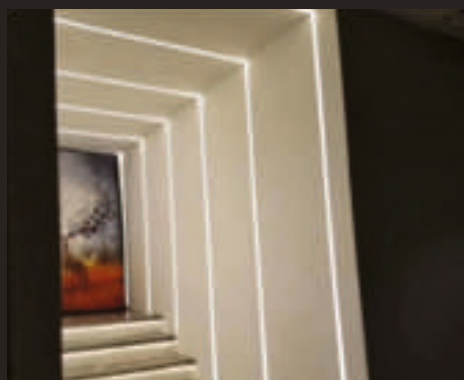



AC3211S

Perfil esquinas externas.
Empotrar.
Longitud: 3000 mm

AC3212

SE VENDE POR SEPARADO



Satinado / Plastico
Aluminio



AC8200S

Perfil tubular suspendido.
Suspender.
Alto: 30mm Ancho: 30mm
Longitud: 3000 mm

AC8202

SE VENDE POR SEPARADO

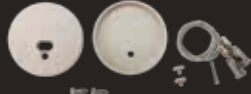

Satinado / Plastico
Aluminio

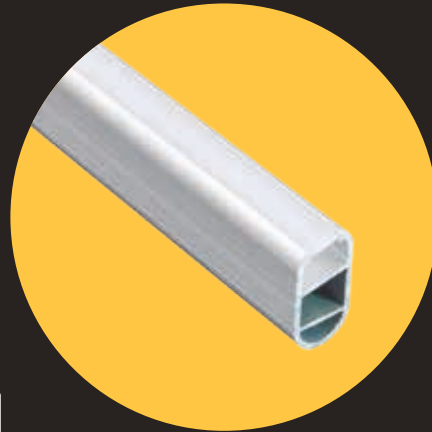

AC8201S

Perfil tubo perchero.
Suspender.
Alto: 30mm Ancho: 15mm
Longitud: 3000 mm

AC8203

SE VENDE POR SEPARADO



Satinado / Plastico
Aluminio

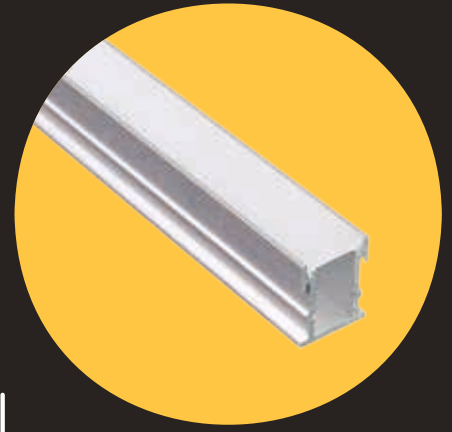

AC3200S

Perfil piso y adoquín.
Empotrar en piso.
Alto: 26mm Ancho: 21mm
Longitud: 3000 mm

AC3201

SE VENDE POR SEPARADO



Satinado / Plastico
Aluminio

DRIVERS



AC7105S

Driver Electrónico Int
Aluminio

Voltaje: 100-277 V- Watts: 15 W
IP 20 - 0.063 Kg Voltaje de salida: 24V



AC7108S

Driver Electrónico Int
Aluminio

Voltaje: 100-277 V- Watts: 180 W
IP 20 - 0.575 Kg - Voltaje de salida: 24V



AC7106

Driver Electrónico Int
Aluminio

Voltaje: 100-277 V- Watts: 60 W
IP 20 - 0.356 Kg - Voltaje de salida: 24 V

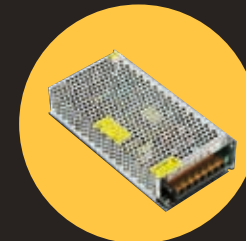

AC7107

Driver Electrónico Int
Aluminio

Voltaje: 100-277 V- Watts: 100 W
IP 20 - 0.455 Kg - Voltaje de salida: 24 V



AC7109S

Driver Electrónico Int
Aluminio

Voltaje: 100-277 V- Watts: 300 W
IP 20 - 0.783 Kg - Voltaje de salida: 24 V



AC7515B

Driver Electrónico Ext
Satinado / Aluminio

Voltaje: 100-277 V- Watts: 150 W
IP 67 - 0.7 Kg



AC7525B

Driver Electrónico Ext
Satinado / Aluminio

Voltaje: 100-277 V- Watts: 250 W
IP 67 - 0.9 Kg

*Las tiras LED y los drivers se venden por separado.

COLGANTE COMERCIAL



CO8040BBNA

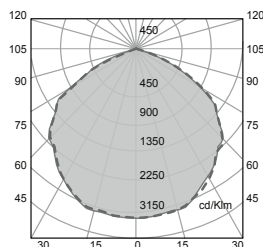
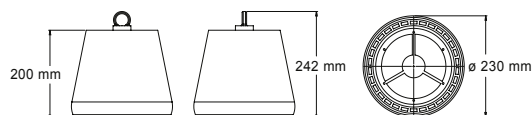

CO8041BBNA



CO8041NBNA



CO8041RBNA

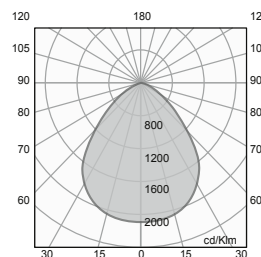
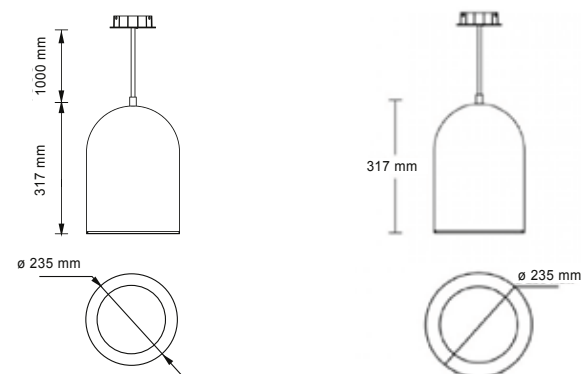

CÓDIGO	MATERIAL DE CUERPO	COLOR	POTENCIA	FLUJO LUMINOSO	ALIMENTACIÓN	TCC	VIDA ÚTIL (L80)	DRIVER	FUENTE DE LUZ	ÁNGULO DE APERTURA (VxH)	IRC	FP	IP	PESO (KG)
CO8040BBNA	Aluminio	□	80 W	8100 lm	127-277 V	□ 4 000 K	50 000 h	Driver Electrónico	LED Integrado	100°	80	0.9	54	3.1
CO8041BBNA	Aluminio	□	40 W	4176 lm	127-277 V	□ 4 000 K	50 000 h	Driver Electrónico	LED Integrado	85°	90	0.9	30	2.9
CO8041NBNA	Aluminio	■	40 W	4176 lm	127-277 V	□ 4 000 K	50 000 h	Driver Electrónico	LED Integrado	85°	90	0.9	30	2.9
CO8041RBNA	Aluminio	■	40 W	4800 lm	127-277 V	□ 4 000 K	50 000 h	Driver Electrónico	LED Integrado	85°	90	0.9	20	2.9

A photograph of a hallway with a glowing green 'SALIDA' sign. The sign is rectangular and mounted on the ceiling, with the word 'SALIDA' in large, bold, green letters and a right-pointing arrow. The hallway is dimly lit, with a green glow emanating from the sign and other fixtures. A large black circle is overlaid on the left side of the image, partially obscuring the hallway. The background shows a ceiling with recessed lighting and a wall with a door frame.

SALIDA

**LUZ DE
SEGURIDAD**

CO6314BBFL

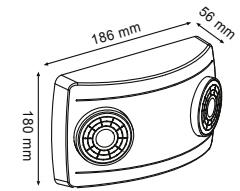
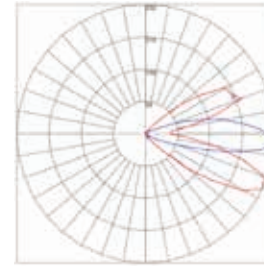

CO6315BVEL

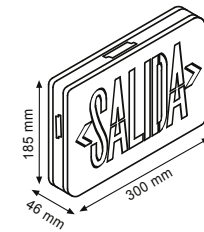
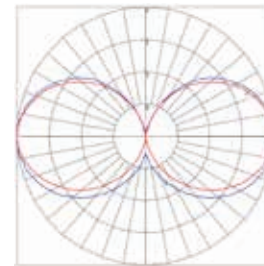

CO6316BVEL

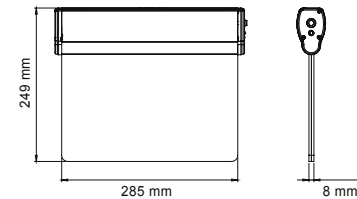

INTERIOR / LUZ DE SEGURIDAD / SOBREPONER

CÓDIGO	MATERIAL DE CUERPO	COLOR	POTENCIA	ALIMENTACIÓN	TCC	VIDA ÚTIL (L80)	DRIVER	FUENTE DE LUZ	ÁNGULO DE APERTURA (vxH)	IRC	IP	PESO (KG)
CO6314BBFL	ABS	<input type="checkbox"/>	2 W	127/277 V	6 500 K	35 000 h	Driver electrónico	LED Integrado	30°	70	30	0.36
CO6315BVEL	ABS	<input type="checkbox"/>	3 W	127/277 V	-	25 000 h	Driver electrónico	LED Integrado	360°	-	30	1.2
CO6316BVEL	Aluminio	<input type="checkbox"/>	3 W	127-277 V	-	25 000 h	Driver electrónico	LED Integrado	360°	-	30	1.25

INDUSTRIAL



IN8853BBFA

LED 75 WATTS 7600 LUMENS 5000K 120° ANGLULO APERTURA IP66 BLANCO

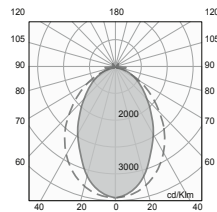

IN8854BBFA

LED 75 WATTS 7600 LUMENS 5000K 120° ANGLULO APERTURA IP66 BLANCO

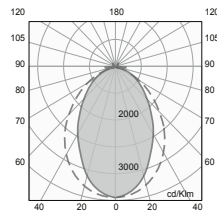

IN8855BBFA

LED 75 WATTS 7600 LUMENS 5000K 40° ANGLULO APERTURA IP66 BLANCO

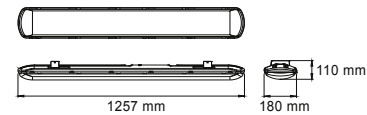
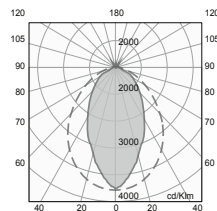

BENEFICIOS

- Ideal para **Industria Alimentaria**
- Alta protección al polvo y agua
- Ahorra energía

IN8906NBFA

LED 270 WATTS 30800 LUMENS 5000K 90° ANGLULO APERTURA IP65 NEGRO

NUEVO

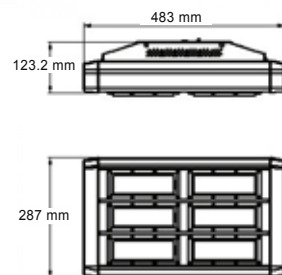
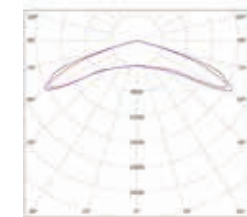

IN8905NBFA

LED 270 WATTS 30800 LUMENS 5000K 60° ANGLULO APERTURA IP65 NEGRO

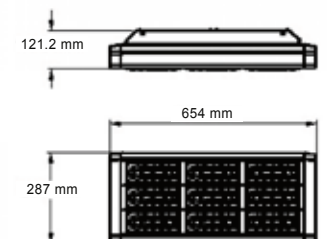
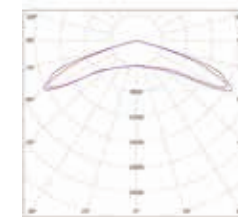

CÓDIGO	MATERIAL DE CUERPO	COLOR	POTENCIA	FLUJO LUMINOSO	ALIMENTACIÓN	TCC	VIDA ÚTIL (L80)	DRIVER	FUENTE DE LUZ	ÁNGULO DE APERTURA (VxH)	IRC	FP	IP	IK	PESO (KG)
IN8853BBFA	Polycarbonato	□	75 W	7600 lm	127-277 V	5 000 K	50 000 h	Driver electrónico	LED Integrado	120°	80	0.9	66	9	2.6
IN8854BBFA	Polycarbonato	□	75 W	7600 lm	127-277 V	5 000 K	50 000 h	Driver electrónico	LED Integrado	60°	80	0.9	66	9	2.6
IN8855BBFA	Polycarbonato	□	75 W	7600 lm	127-277 V	5 000 K	50 000 h	Driver electrónico	LED Integrado	40°	80	0.9	66	9	2.6
IN8906NBFA	Aluminio	■	270 W	30800 lm	127-277 V	5 000 K	50 000 h	Driver electrónico	LED Integrado	90°	70	0.95	65	8	6.9
IN8905NBFA	Aluminio	■	270 W	30800 lm	127-277 V	5 000 K	50 000 h	Driver electrónico	LED Integrado	60°	70	0.95	65	8	6.9

IN4607BBFA

LED 180 WATTS 20530 LUMENS 5000K 120° ANGULO APERTURA IP66 BLANCO

DIMEARBLE 0-10 V 7-11 ALTURA RECOMENDADA

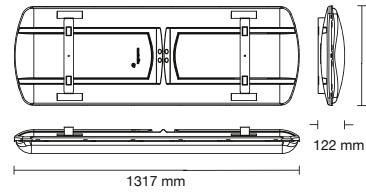
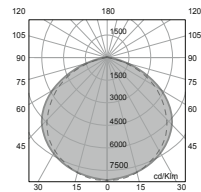
**IN4609BBFA**

LED 180 WATTS 20530 LUMENS 5000K 60° ANGULO APERTURA IP66 BLANCO

DIMEARBLE 0-10 V 7-11 ALTURA RECOMENDADA

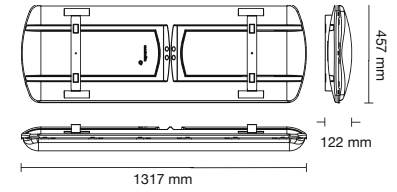
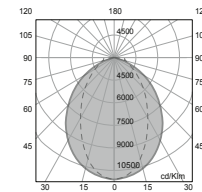
**IN4608BBFA**

LED 100 WATTS 11400 LUMENS 5000K 120° ANGULO APERTURA IP66 BLANCO

DIMEARBLE 0-10 V 4-7 ALTURA RECOMENDADA

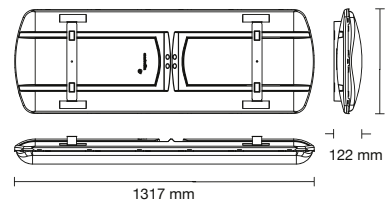
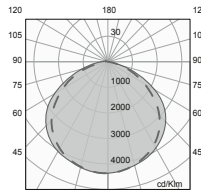
**IN4610BBFA**

LED 100 WATTS 11400 LUMENS 5000K 60° ANGULO APERTURA IP66 BLANCO

DIMEARBLE 0-10 V 4-7 ALTURA RECOMENDADA

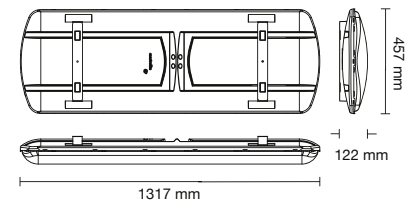
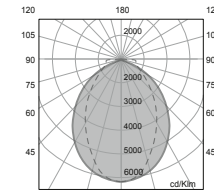
**BENEFICIOS**

- Ideal para **Industria Alimentaria**
- Alta protección al polvo y agua
- Ahorra energía

CÓDIGO	MATERIAL DE CUERPO	COLOR	POTENCIA	FLUJO LUMINOSO	ALIMENTACIÓN	TCC	VIDA ÚTIL(L80)	DRIVER	FUENTE DE LUZ	ÁNGULO DE APERTURA (VxH)	IRC	FP	IP	IK	PESO (KG)
IN4607BBFA	Policarbonato	☐	180 W	20530 lm	127-277 V	5 000 K	50 000 h	Driver electrónico	LED Integrado	120°	80	0.9	66	9	6.5
IN4609BBFA	Policarbonato	☐	180 W	20530 lm	127-277 V	5 000 K	50 000 h	Driver electrónico	LED Integrado	60°	80	0.9	66	9	6.5
IN4608BBFA	Policarbonato	☐	100 W	11400 lm	127-277 V	5 000 K	50 000 h	Driver electrónico	LED Integrado	120°	80	0.9	66	9	6.5
IN4610BBFA	Policarbonato	☐	100 W	11400 lm	127-277 V	5 000 K	50 000 h	Driver electrónico	LED Integrado	60°	80	0.9	66	9	6.5

IN4800BBFA

LED 44.5 WATTS 5883 LUMENS 5000K 143° ANGINLO APERTURA BLANCO

NUEVO



*Ideal para autoservicios

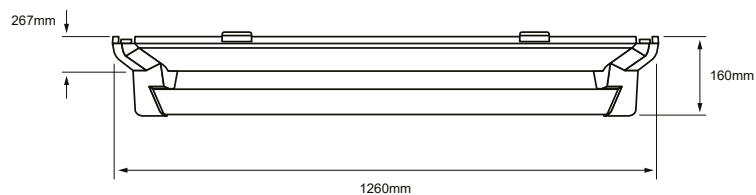
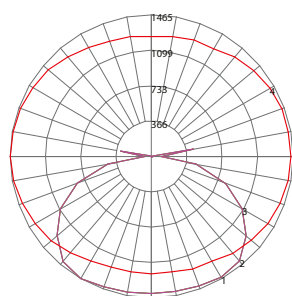

BENEFICIOS

- Ideal para **Industria Alimentaria**
- Alta protección al polvo y agua
- Ahorra energía

CÓDIGO	MATERIAL DE CUERPO	COLOR	POTENCIA	FLUJO LUMINOSO	ALIMENTACIÓN	TCC	VIDA ÚTIL (L80)	DRIVER	FUENTE DE LUZ	ÁNGULO DE APERTURA (VxH)	IRC	FP	IP	IK	PESO (KG)
IN4800BBFA	Aluminio/ Plastico	□	44.5 W	5883 lm	100-277 V ~	□ 5 000 K	50 000 h	Driver LED	LED Integrado	143°	80	0.9	20	8	4.5

IN8025BBNA

LED 100 WATTS 13500 LUMENS 4000K 120° ANGULO APERTURA IP69K BLANCO



IN8026BBNA

LED 150 WATTS 20000 LUMENS 4000K 120° ANGULO APERTURA IP69K BLANCO



IN8027BBNA

LED 200 WATTS 26000 LUMENS 4000K 120° ANGULO APERTURA IP69K BLANCO

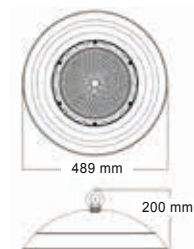
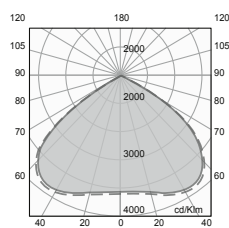

CÓDIGO	MATERIAL DE CUERPO	COLOR	POTENCIA	FLUJO LUMINOSO	ALIMENTACIÓN	TCC	VIDA ÚTIL (L80)	DRIVER	FUENTE DE LUZ	ÁNGULO DE APERTURA (VxH)	IRC	FP	IP	IK	PESO (KG)
IN8025BBNA	Aluminio	<input type="checkbox"/>	100 W	13500 lm	127-277 V	<input type="checkbox"/> 4 000 K	50 000 h	Driver electrónico	LED Integrado	120°	80	0.9	69K	8	9.5
IN8026BBNA	Aluminio	<input type="checkbox"/>	150 W	20000 lm	127-277 V	<input type="checkbox"/> 4 000 K	50 000 h	Driver electrónico	LED Integrado	120°	80	0.9	69K	8	9.5
IN8027BBNA	Aluminio	<input type="checkbox"/>	200 W	26000 lm	127-277 V	<input type="checkbox"/> 4 000 K	50 000 h	Driver electrónico	LED Integrado	120°	80	0.9	69K	8	9.5

IN8200BBFA

LED 150 WATTS 19750 LUMENS 5000K 120° ANGULO APERTURA IP20 BLANCO

NUEVO



*Incluye 3 ópticas intercambiables de 60°, 90° y 120°
 *Posibilidad para interconexión mecánica en línea

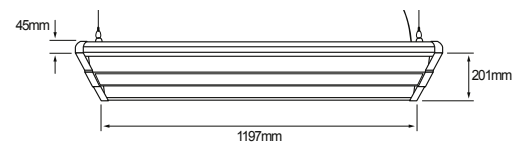
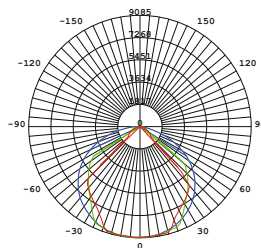

CÓDIGO	MATERIAL DE CUERPO	COLOR	POTENCIA	FLUJO LUMINOSO	ALIMENTACIÓN	TCC	VIDA ÚTIL (L80)	DRIVER	FUENTE DE LUZ	ÁNGULO DE APERTURA (VxH)	IRC	FP	IP	IK	PESO (KG)
IN8200BBFA	Aluminio/PC	□	150 W	19750 lm	100-277 V ~	□ 5 000 K	50 000 h	Driver LED	LED Integrado	120°	80	0.9	20	-	4.5

*Construlita se reserva el derecho de modificar la información sin previo aviso y no se hace responsable por errores u omisiones en este documento.

IN8208BBFA

LED 100 WATTS 10500 LUMENS 5000K 120° ANGULO APERTURA IP30 BLANCO

NUEVO**IN8209BBFA**

LED 100 WATTS 10500 LUMENS 5000K 60° ANGULO APERTURA IP30 BLANCO

IN8209BBNA

LED 100 WATTS 10500 LUMENS 4000K 60° ANGULO APERTURA IP30 BLANCO

IN8210BBFA

LED 100 WATTS 10500 LUMENS 5000K 40° ANGULO APERTURA IP30 BLANCO

IN8210BBNA

LED 100 WATTS 10500 LUMENS 4000K 40° ANGULO APERTURA IP30 BLANCO

4.7
DIMEABLE ALTURA RECOMENDADA

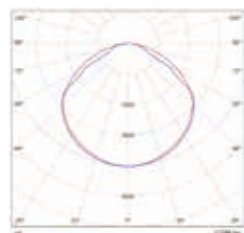

IN8208

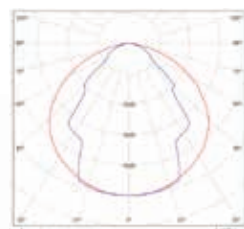

IN8209 y IN8210

IN8211BBFA

LED 150 WATTS 15750 LUMENS 5000K 120° ANGULO APERTURA IP30 BLANCO

NUEVO**IN8212BBFA**

LED 150 WATTS 15750 LUMENS 5000K 60° ANGULO APERTURA IP30 BLANCO

IN8212BBNA

LED 150 WATTS 15750 LUMENS 4000K 60° ANGULO APERTURA IP30 BLANCO

IN8213BBNA

LED 150 WATTS 15750 LUMENS 4000K 40° ANGULO APERTURA IP30 BLANCO

6.9
DIMEABLE ALTURA RECOMENDADA

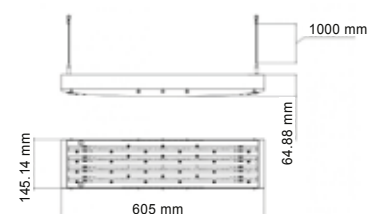
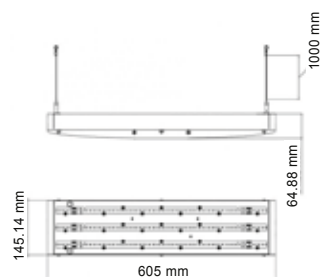
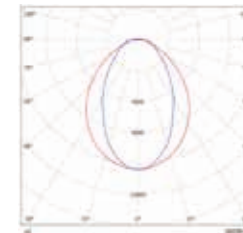

CÓDIGO	MATERIAL DE CUERPO	COLOR	POTENCIA	FLUJO LUMINOSO	ALIMENTACIÓN	TCC	VIDA ÚTIL (L80)	DRIVER	FUENTE DE LUZ	ÁNGULO DE APERTURA (VxH)	IRC	FP	IP	PESO (KG)
IN8208BBFA	Acero	<input type="checkbox"/>	100 W	10500 lm	127-277 V	5 000 K	50 000 h	Driver electrónico	LED Integrado	120°	80	0.9	30	4.5
IN8209BBFA	Acero	<input type="checkbox"/>	100 W	10500 lm	127-277 V	5 000 K	50 000 h	Driver electrónico	LED Integrado	60°	80	0.9	30	4.5
IN8209BBNA	Acero	<input type="checkbox"/>	100 W	10500 lm	127-277 V	4 000 K	50 000 h	Driver electrónico	LED Integrado	60°	80	0.9	30	4.5
IN8210BBFA	Acero	<input type="checkbox"/>	100 W	10500 lm	127-277 V	5 000 K	50 000 h	Driver electrónico	LED Integrado	40°	80	0.9	30	4.5
IN8210BBNA	Acero	<input type="checkbox"/>	100 W	10500 lm	127-277 V	4 000 K	50 000 h	Driver electrónico	LED Integrado	40°	80	0.9	30	4.5
IN8211BBFA	Acero	<input type="checkbox"/>	150 W	15750 lm	127-277 V	5 000 K	50 000 h	Driver electrónico	LED Integrado	120°	80	0.9	30	4.5
IN8212BBFA	Acero	<input type="checkbox"/>	150 W	15750 lm	127-277 V	5 000 K	50 000 h	Driver electrónico	LED Integrado	60°	80	0.9	30	4.5
IN8212BBNA	Acero	<input type="checkbox"/>	150 W	15750 lm	127-277 V	4 000 K	50 000 h	Driver electrónico	LED Integrado	60°	80	0.9	30	4.5
IN8213BBNA	Acero	<input type="checkbox"/>	150 W	15750 lm	127-277 V	4 000 K	50 000 h	Driver electrónico	LED Integrado	40°	80	0.9	30	4.5

IN8218BBFA

LED 270 WATTS 31500 LUMENS 5000K 40° ANGULO APERTURA IP30 BLANCO

NUEVO

IN8218BBNA

LED 270 WATTS 31500 LUMENS 4000K 40° ANGULO APERTURA IP30 BLANCO

IN8219BBFA

LED 270 WATTS 31500 LUMENS 5000K 60° ANGULO APERTURA IP30 BLANCO

IN8219BBNA

LED 270 WATTS 31500 LUMENS 4000K 60° ANGULO APERTURA IP30 BLANCO

IN8217BBFA

LED 270 WATTS 31500 LUMENS 5000K 120° ANGULO APERTURA IP30 BLANCO

8-15
ALTIMA RECOMENDADA

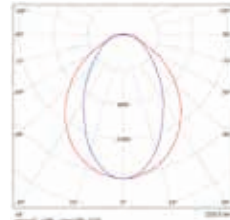

IN8218

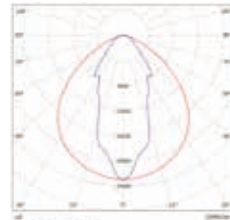

IN8219

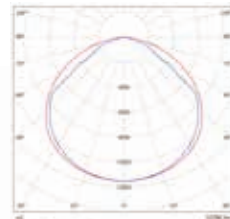

IN8217

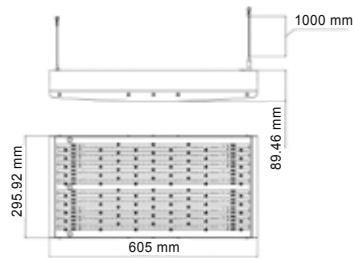

IN8214BBFA

LED 200 WATTS 21000 LUMENS 5000K 120° ANGULO APERTURA IP30 BLANCO

NUEVO

IN8215BBFA

LED 200 WATTS 21000 LUMENS 5000K 60° ANGULO APERTURA IP30 BLANCO

IN8215BBNA

LED 200 WATTS 21000 LUMENS 4000K 60° ANGULO APERTURA IP30 BLANCO

IN8216BBFA

LED 200 WATTS 21000 LUMENS 5000K 40° ANGULO APERTURA IP30 BLANCO

IN8216BBNA

LED 200 WATTS 21000 LUMENS 4000K 40° ANGULO APERTURA IP30 BLANCO

7-11
ALTIMA RECOMENDADA

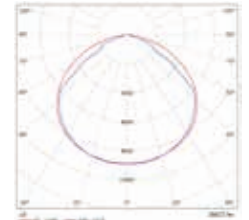

IN8214

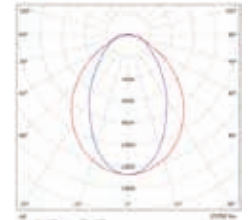

IN8215 y IN8216

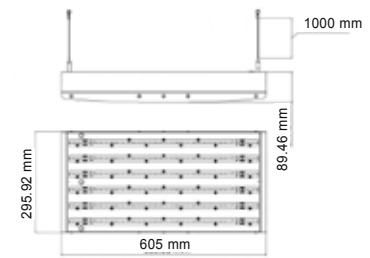

CÓDIGO	MATERIAL DE CUERPO	COLOR	POTENCIA	FLUJO LUMINOSO	ALIMENTACIÓN	TCC	VIDA ÚTIL (L80)	DRIVER	FUENTE DE LUZ	ÁNGULO DE APERTURA (VxH)	IRC	FP	IP	PESO (KG)
IN8218BBFA	Acero	<input type="checkbox"/>	270 W	31500 lm	127-277 V	5 000 K	50 000 h	Driver electrónico	LED Integrado	60°	80	0.9	30	6
IN8218BBNA	Acero	<input type="checkbox"/>	270 W	31500 lm	127-277 V	4 000 K	50 000 h	Driver electrónico	LED Integrado	60°	80	0.9	30	6
IN8219BBFA	Acero	<input type="checkbox"/>	270 W	31500 lm	127-277 V	5 000 K	50 000 h	Driver electrónico	LED Integrado	40°	80	0.9	30	6
IN8219BBNA	Acero	<input type="checkbox"/>	270 W	31500 lm	127-277 V	4 000 K	50 000 h	Driver electrónico	LED Integrado	40°	80	0.9	30	6
IN8217BBFA	Acero	<input type="checkbox"/>	270 W	31500 lm	127-277 V	5 000 K	50 000 h	Driver electrónico	LED Integrado	120°	80	0.9	30	6
IN8214BBFA	Acero	<input type="checkbox"/>	200 W	21000 lm	127-277 V	5 000 K	50 000 h	Driver electrónico	LED Integrado	120°	80	0.9	30	6
IN8215BBFA	Acero	<input type="checkbox"/>	200 W	21000 lm	127-277 V	5 000 K	50 000 h	Driver electrónico	LED Integrado	60°	80	0.9	30	6
IN8215BBNA	Acero	<input type="checkbox"/>	200 W	21000 lm	127-277 V	4 000 K	50 000 h	Driver electrónico	LED Integrado	60°	80	0.9	30	6
IN8216BBFA	Acero	<input type="checkbox"/>	200 W	21000 lm	127-277 V	5 000 K	50 000 h	Driver electrónico	LED Integrado	40°	80	0.9	30	6
IN8216BBNA	Acero	<input type="checkbox"/>	200 W	21000 lm	127-277 V	4 000 K	50 000 h	Driver electrónico	LED Integrado	40°	80	0.9	30	6

*Construlita se reserva el derecho de modificar la información sin previo aviso y no se hace responsable por errores u omisiones en este documento.



INDUSTRIAL UFO

IN8028NBFA

LED 100 WATTS 17200 LUMENS 5000K 90° ANGLULO APERTURA IP65 NEGRO

NUEVO

 *Incluye cables para atenuación

IN8029NBFA

LED 150 WATTS 25490 LUMENS 5000K 90° ANGLULO APERTURA IP65 NEGRO

NUEVO

 *Incluye cables para atenuación

IN8030NBFA

LED 200 WATTS 33470 LUMENS 5000K 90° ANGLULO APERTURA IP65 NEGRO

NUEVO

 *Incluye cables para atenuación

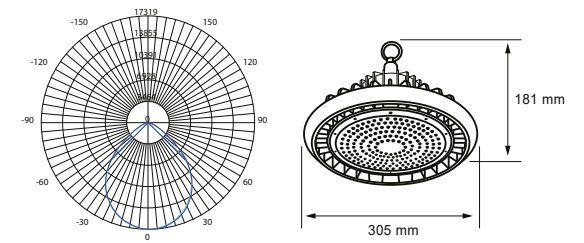
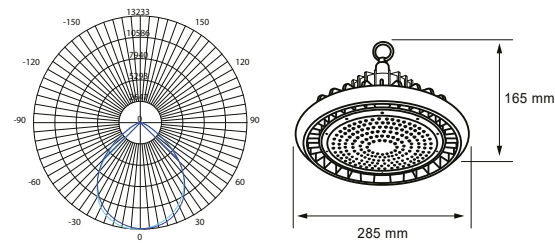
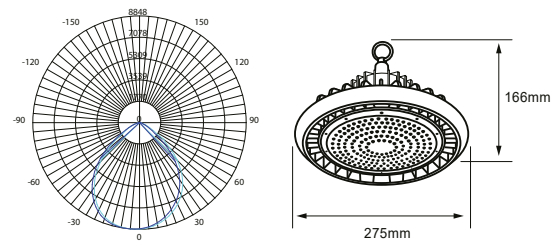

- Incluye argolla para suspensión y bracket para sobreponer (dirigible)
- Alta eficiencia luminosa 170 Lm/W
- IK 10 (resistencia al impacto)
- Convección natural de aire con LEDs distribuidos desde el centro de la PCB para evitar el sobrecalentamiento.

CÓDIGO	MATERIAL DE CUERPO	COLOR	POTENCIA	FLUJO LUMINOSO	ALIMENTACIÓN	TCC	VIDA ÚTIL (L80)	DRIVER	FUENTE DE LUZ	ÁNGULO DE APERTURA (VxH)	IRC	FP	IP	IK	PESO (KG)
IN8028NBFA	Aluminio/PC	■	100 W	17200 lm	100-277 V ~	5 000 K	50000 h	Driver electrónico	LED Integrado	90°	80	0.9	65	10	2
IN8029NBFA	Aluminio/PC	■	150 W	25490 lm	100-277 V ~	5 000 K	50000 h	Driver electrónico	LED Integrado	90°	80	0.9	65	10	2.3
IN8030NBFA	Aluminio/PC	■	200 W	33470 lm	100-277 V ~	5 000 K	50000 h	Driver electrónico	LED Integrado	90°	80	0.9	65	10	3

IN8007BBCA

LED 150 WATTS 15800 LUMENS 3000K 100° ANGULO APERTURA IP30 BLANCO

IN8007BBFA

LED 150 WATTS 15800 LUMENS 5000K 100° ANGULO APERTURA IP30 BLANCO

IN8007BBNA

LED 150 WATTS 15800 LUMENS 4000K 100° ANGULO APERTURA IP30 BLANCO

IN8007NBNA

LED 150 WATTS 15800 LUMENS 4000K 100° ANGULO APERTURA IP30 NEGRO



IN8006SBFB

LED 100 WATTS 12000 LUMENS 5000K 120° ANGULO APERTURA IP65 GRIS

NUEVO

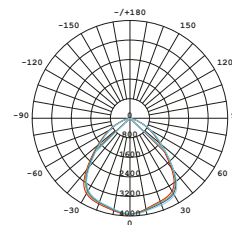
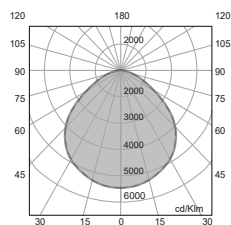
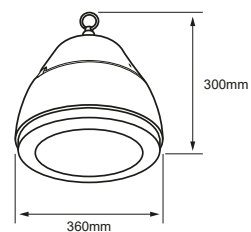
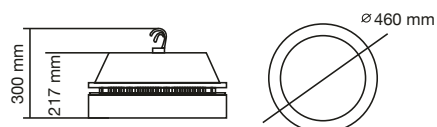

CÓDIGO	MATERIAL DE CUERPO	COLOR	POTENCIA	FLUJO LUMINOSO	ALIMENTACIÓN	TCC	VIDA ÚTIL (L80)	DRIVER	FUENTE DE LUZ	ÁNGULO DE APERTURA (VxH)	IRC	FP	IP	IK	PESO (KG)
IN8007BBCA	Aluminio	□	150 W	15800 lm	127-277 V	3 000 K	50 000 h	Driver electrónico	LED Integrado	100°	80	0.95	30	-	13.84
IN8007BBFA	Aluminio	□	150 W	15800 lm	127-277 V	5 000 K	50 000 h	Driver electrónico	LED Integrado	100°	80	0.95	30	-	13.84
IN8007BBNA	Aluminio	□	150 W	15800 lm	127-277 V	4 000 K	50 000 h	Driver electrónico	LED Integrado	100°	80	0.95	30	-	13.84
IN8007NBNA	Aluminio	■	150 W	15800 lm	127-277 V	4 000 K	50 000 h	Driver electrónico	LED Integrado	100°	80	0.95	30	-	13.84
IN8006SBFB	Aluminio	■	100 W	12000 lm	100-240 V ~	5 000 K	50000 h	Driver LED	LED Integrado	120°	90	0.9	65	8	8.5

2 b

la fiesta nunca termina ^{CON LOS} 10+

El café
AYUDA A QUIEN
DUERME POCO
Y SUEÑA
MUCHO

simplemente
a tu box

BOCANEGRA

50

GALLETAS

← POR AQUÍ

CIGARROS

Fratelli

Lonchi Boni

INDUSTRIAL LINEAL



IN8849BBFA

LED 73 WATTS 8200 LUMENS 5000K 100° ANGLULO APERTURA IP30 BLANCO

NUEVO

IN8849NBFA

LED 73 WATTS 8200 LUMENS 5000K 100° ANGLULO APERTURA IP30 NEGRO

NUEVO



* Incluye sistema de suspensión 1.5m
* Interconexión de 17pzas a 277 V
* Interconexión de 8pzas a 127 V

IN8846BBFA

LED 73 WATTS 8200 LUMENS 5000K 100° ANGLULO APERTURA IP30 BLANCO

IN8846NBFA

LED 73 WATTS 8200 LUMENS 5000K 100° ANGLULO APERTURA IP30 NEGRO

IN8850BBFA

LED 73 WATTS 8200 LUMENS 5000K 120° ANGLULO APERTURA IP30 BLANCO

NUEVO

IN8850NBFA

LED 73 WATTS 8200 LUMENS 5000K 120° ANGLULO APERTURA IP30 NEGRO

NUEVO



* Incluye sistema de suspensión 1.5m
* Interconexión de 17pzas a 277 V
* Interconexión de 8pzas a 127 V

IN8847BBFA

LED 73 WATTS 8200 LUMENS 5000K 120° ANGLULO APERTURA IP30 BLANCO

IN8847NBFA

LED 73 WATTS 8200 LUMENS 5000K 120° ANGLULO APERTURA IP30 NEGRO

IN8851BBFA

LED 73 WATTS 8200 LUMENS 5000K 60° ANGLULO APERTURA IP30 BLANCO

NUEVO

IN8851NBFA

LED 73 WATTS 8200 LUMENS 5000K 60° ANGLULO APERTURA IP30 NEGRO

NUEVO



* Incluye sistema de suspensión 1.5m
* Interconexión de 17pzas a 277 V
* Interconexión de 8pzas a 127 V

IN8848BBFA

LED 73 WATTS 8200 LUMENS 5000K 60° ANGLULO APERTURA IP30 BLANCO

IN8848NBFA

LED 73 WATTS 8200 LUMENS 5000K 60° ANGLULO APERTURA IP30 NEGRO

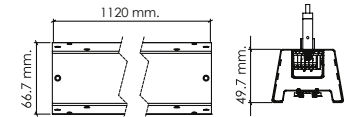
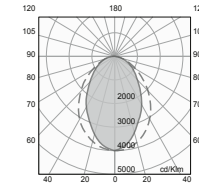
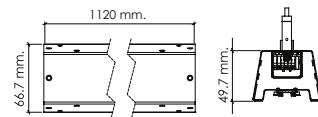
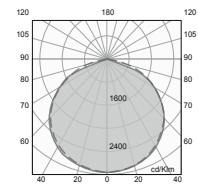
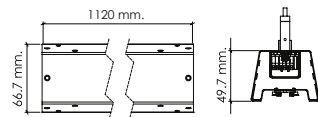
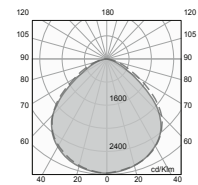

CÓDIGO	MATERIAL DE CUERPO	COLOR	POTENCIA	FLUJO LUMINOSO	ALIMENTACIÓN	TCC	VIDA ÚTIL (L80)	DRIVER	FUENTE DE LUZ	ÁNGULO DE APERTURA (VxH)	IRC	FP	IP	PESO (KG)
IN8849BBFA	Acero	Blanco	73 W	8200 lm	127-277 V	5 000 K	50 000 h	Driver electrónico	LED Integrado	100°	70	0.9	30	2.4
IN8849NBFA	Acero	Negro	73 W	8200 lm	127-277 V	5 000 K	50 000 h	Driver electrónico	LED Integrado	100°	70	0.9	30	2.4
IN8846BBFA	Acero	Blanco	73 W	8200 lm	127-277 V	5 000 K	50 000 h	Driver electrónico	LED Integrado	100°	70	0.9	30	2.4
IN8846NBFA	Acero	Negro	73 W	8200 lm	127-277 V	5 000 K	50 000 h	Driver electrónico	LED Integrado	100°	70	0.9	30	2.4
IN8850BBFA	Acero	Blanco	73 W	8200 lm	127-277 V	5 000 K	50 000 h	Driver electrónico	LED Integrado	120°	70	0.9	30	2.4
IN8850NBFA	Acero	Negro	73 W	8200 lm	127-277 V	5 000 K	50 000 h	Driver electrónico	LED Integrado	120°	70	0.9	30	2.4
IN8847BBFA	Acero	Blanco	73 W	8200 lm	127-277 V	5 000 K	50 000 h	Driver electrónico	LED Integrado	120°	70	0.9	30	2.4
IN8847NBFA	Acero	Negro	73 W	8200 lm	127-277 V	5 000 K	50 000 h	Driver electrónico	LED Integrado	120°	70	0.9	30	2.4
IN8851BBFA	Acero	Blanco	73 W	8200 lm	127-277 V	5 000 K	50 000 h	Driver electrónico	LED Integrado	60°	70	0.9	30	2.4
IN8851NBFA	Acero	Negro	73 W	8200 lm	127-277 V	5 000 K	50 000 h	Driver electrónico	LED Integrado	60°	70	0.9	30	2.4
IN8848BBFA	Acero	Blanco	73 W	8200 lm	127-277 V	5 000 K	50 000 h	Driver electrónico	LED Integrado	60°	70	0.9	30	2.4
IN8848NBFA	Acero	Negro	73 W	8200 lm	127-277 V	5 000 K	50 000 h	Driver electrónico	LED Integrado	60°	70	0.9	30	2.4

*Construlita se reserva el derecho de modificar la información sin previo aviso y no se hace responsable por errores u omisiones en este documento.

A PRUEBA DE HUMEDAD





IN4032GCCA

LED 15 WATTS 25 WATTS 30 WATTS 36 WATTS 3000K 4000K 5000K 110° ANGULO APERTURA IP65 GRIS



NUEVO

* Flujo luminoso de 1950 / 3250 / 3900 / 4680 lm de acuerdo a la potencia seleccionada

* Interconexión:

110 V - 15pzas

200 V - 30 pzs

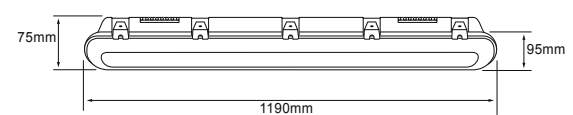
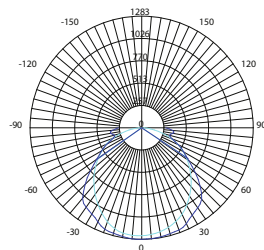

CÓDIGO	MATERIAL DE CUERPO	COLOR	POTENCIA	ALIMENTACIÓN	TCC	VIDA ÚTIL (L80)	DRIVER	FUENTE DE LUZ	ÁNGULO DE APERTURA (VxH)	IRC	FP	IP	IK	PESO (KG)
IN4032GCCA	ABS/PC	■	15 W / 25 W / 30 W / 36 W	100-277 V ~	□ 3000 □ 4000 5000K	50000 h	Driver Electrónico	LED Integrado	110°	80	0.9	65	8	1.98

IN4043GBNB

LED 18 WATTS 1900 LUMENS 4000K 120° ANGULO APERTURA IP65 GRIS

NUEVO

INTERCONEXIÓN

* Interconexión:
100 V hasta 32pzas
220 V hasta 69pzas
277 V hasta 87pzas

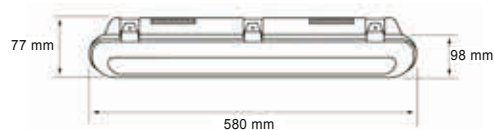
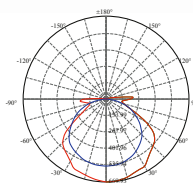
**IN4044GBNB**

LED 40 WATTS 4100 LUMENS 4000K 120° ANGULO APERTURA IP65 GRIS

NUEVO

INTERCONEXIÓN

* Interconexión:
100 V hasta 17pzas
220 V hasta 37pzas
277 V hasta 46pzas

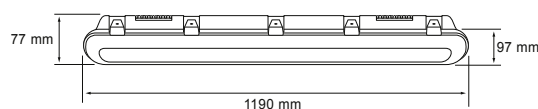
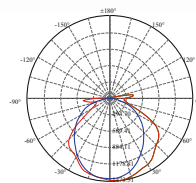
**IN4045GBNB**

LED 56 WATTS 5700 LUMENS 4000K 120° ANGULO APERTURA IP65 GRIS

NUEVO

INTERCONEXIÓN

* Interconexión:
100 V hasta 12pzas
220 V hasta 26pzas
277 V hasta 33pzas

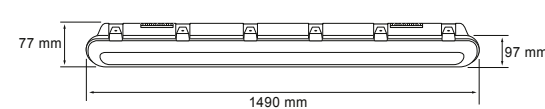
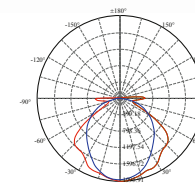
**IN4030GBNA**

LED 40 WATTS 5200 LUMENS 4000K 120° ANGULO APERTURA IP65 GRIS

NUEVO

INTERCONEXIÓN

* Incluye accesorio de suspensión 1.5m
* Interconexión:
7pzas a 100 V
8pzas a 220 V
16pzas a 230V
20pzas a 277V

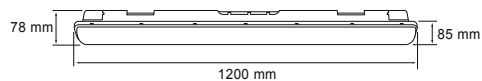
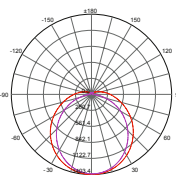
**IN4338BBNA**

LED 38 WATTS 3200 LUMENS 4000K 120° ANGULO APERTURA IP65 BLANCO

* En una instalación con calibre 12AWG menos a 20mm, interconexión:
32 pz as a 277V
16 pz as a 127V

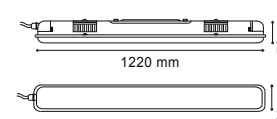
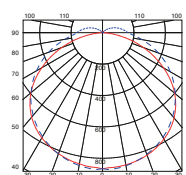

CÓDIGO	MATERIAL DE CUERPO	COLOR	POTENCIA	FLUJO LUMINOSO	ALIMENTACIÓN	TCC	VIDA ÚTIL(L80)	DRIVER	FUENTE DE LUZ	ÁNGULO DE APERTURA (VxH)	IRC	FP	IP	IK	PESO (KG)
IN4043GBNB	Gris	■	18 W	1900 lm	100-277V ~	□ 4 000 K	30 000 h	Driver electrónico	LED Integrado	120°	80	0.9	65	8	1
IN4044GBNB	Gris	■	40 W	4100 lm	100-277V ~	□ 4 000 K	30 000 h	Driver electrónico	LED Integrado	120°	80	0.9	65	8	1.6
IN4045GBNB	Gris	■	56 W	5700 lm	100-277V ~	□ 4 000 K	30 000 h	Driver electrónico	LED Integrado	120°	80	0.9	65	8	2.1
IN4030GBNA	Gris	■	40 W	5200 lm	100-277V ~	□ 4 000 K	50 000 h	Driver electrónico	LED Integrado	120°	80	0.9	65	8	1.93
IN4338BBNA	Polycarbonato	□	38 W	3200 lm	127-277 V	□ 4 000 K	25 000 h	Driver electrónico	LED Integrado	120°	80	0.9	65	8	2.2

IN4041BBNA

LED 37 WATTS 3291 LUMENS 4000K 110° ANGLULO APERTURA IP65 BLANCO

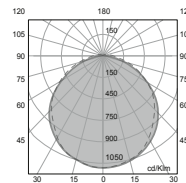
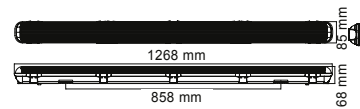

OF4038BBFA

LED 2x15 WATTS 2500 LUMENS 6500K 110x150° ANGLULO APERTURA IP65 BLANCO

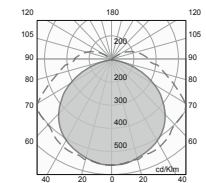
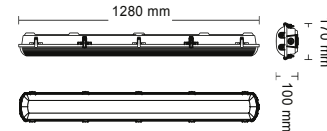

BENEFICIOS

- Bajo mantenimiento
- Led integrado
- Ahorra energía

OF4027BBNA

LED 27 WATTS 2760 LUMENS 4000K 120° ANGLULO APERTURA IP66 BLANCO

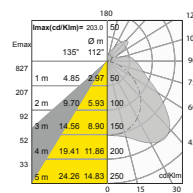
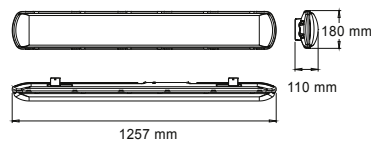

OF4138BBNA

LED 2x18 WATTS 2300 LUMENS 4000K 110/150° ANGLULO APERTURA IP65 BLANCO

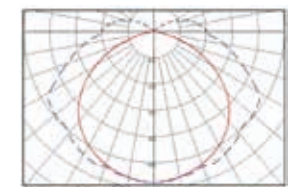
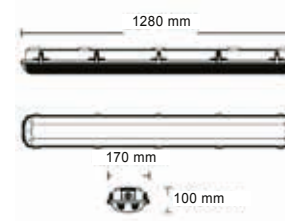

CÓDIGO	MATERIAL DE CUERPO	COLOR	POTENCIA	FLUJO LUMINOSO	ALIMENTACIÓN	TCC	VIDA ÚTIL (L80)	DRIVER	FUENTE DE LUZ	ÁNGULO DE APERTURA (vxH)	IRC	FP	IP	IK	PESO (KG)
IN4041BBNA	Policarbonato	<input type="checkbox"/>	37 W	3291 lm	127-277 V	<input type="checkbox"/> 4 000 K	30 000 h	Driver electrónico	LED Integrado	110°	80	0.9	65	-	2.3
OF4038BBFA	Policarbonato	<input type="checkbox"/>	2X15 W	2500 lm	127-277 V	<input type="checkbox"/> 6 500 K	25 000 h	-	T8	110x150°	80	0.95	65	-	3.6
OF4027BBNA	Policarbonato	<input type="checkbox"/>	27 W	2760 lm	127-277 V	<input type="checkbox"/> 4 000 K	50 000 h	Driver electrónico	LED Integrado	120°	80	0.9	66	9	2.6
OF4138BBNA	Policarbonato	<input type="checkbox"/>	2X18 W	2300 lm	127-277 V	<input type="checkbox"/> 4 000 K	25 000 h	-	T8	110/60°	80	0.5	65	-	3.6

EXTERIOR

ESPACIOS RENOVADOS

La combinación de diseño e iluminación de la tecnología LED, además de ahorrar recursos, cumple con los requisitos funcionales y estéticos, crea exteriores seguros y renovados listos para una experiencia nocturna única.

CONSTRULITA[®]
EL SENTIDO DE LA LUZ





antano

MOON LIGHT



OU3404SLAA LUZ AQUA
 OU3404SLVA LUZ LAVANDER BLUE
 OU3404SLJA LUZ LIGHT JADE

LED 50 WATTS 30° ANGULO APERTURA IP67 SATINADO

NUEVO

MODO DE INSTALACIÓN

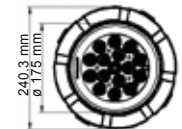
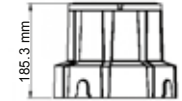
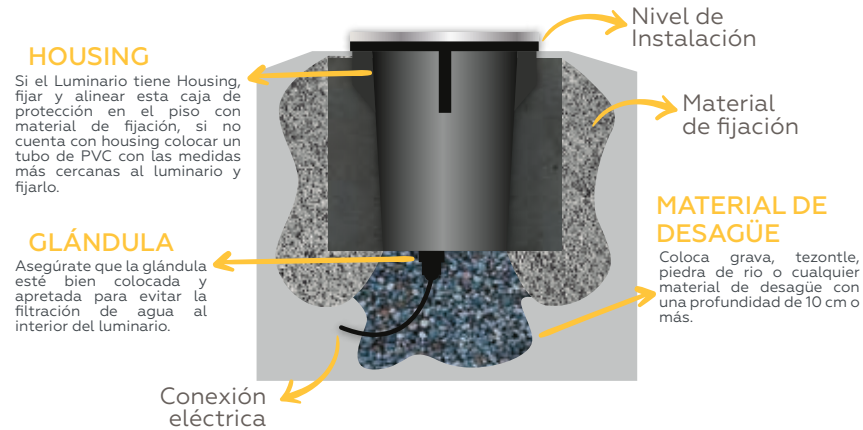

OU3405SLAA LUZ AQUA
 OU3405SLVA LUZ LAVANDER BLUE
 OU3405SLJA LUZ LIGHT JADE

LED 50 WATTS 10x40° ANGULO APERTURA IP67 SATINADO

NUEVO



PARA INSTALACIÓN EN JARDÍN

Instala la tapa arriba del nivel del piso: Tierra y Jardín

No olvides revisar la glándula y colocar material de desagüe.

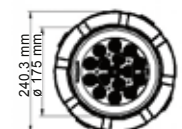

CÓDIGO	MATERIAL DE CUERPO	COLOR	POTENCIA	ALIMENTACIÓN	VIDA ÚTIL (L80)	DRIVER	FUENTE DE LUZ	ÁNGULO DE APERTURA (VxH)	FP	IP	CORTE DE EMPOTRAMIENTO	IK	PESO (KG)
OU3404SLAA	Aluminio	■	50 W	127-277 V	50 000 h	Driver electrónico	LED Integrado	30°	0.95	67	240X185 mm	9	2.8
OU3404SLVA	Aluminio	■	50 W	127-277 V	50 000 h	Driver electrónico	LED Integrado	30°	0.95	67	240X185 mm	9	2.8
OU3404SLJA	Aluminio	■	50 W	127-277 V	50 000 h	Driver electrónico	LED Integrado	30°	0.95	67	240X185 mm	9	2.8
OU3405SLAA	Aluminio	■	50 W	127-277 V	50 000 h	Driver electrónico	LED Integrado	10x40°	0.95	67	240X185 mm	9	2.8
OU3405SLVA	Aluminio	■	50 W	127-277 V	50 000 h	Driver electrónico	LED Integrado	10x40°	0.95	67	240X185 mm	9	2.8
OU3405SLJA	Aluminio	■	50 W	127-277 V	50 000 h	Driver electrónico	LED Integrado	10x40°	0.95	67	240X185 mm	9	2.8

OU3402GLAA LUZ AQUA
OU3402GLJA LUZ LIGHT JADE
OU3402GLVA LUZ LAVANDER BLUE

LED 50 WATTS 30° ANGLULO APERTURA IP67 GRIS

NUEVO

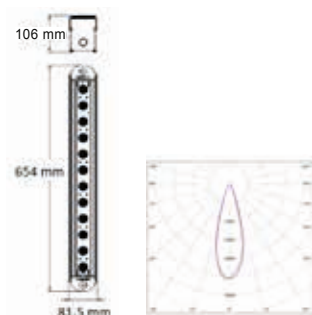

OU3403GLAA LUZ AQUA
OU3403GLJA LUZ LIGHT JADE
OU3403GLVA LUZ LAVANDER BLUE

LED 50 WATTS 10x40° ANGLULO APERTURA IP67 GRIS

NUEVO

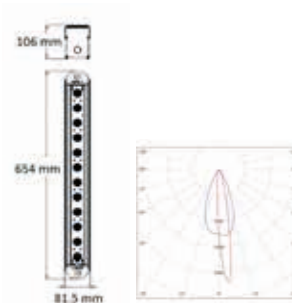

OU3400GLAA LUZ AQUA
OU3400GLCA LUZ CAPRI
OU3400GLEA LUZ ELECTRIC GREEN
OU3400GLJA LUZ LIGHT JADE
OU3400GLVA LUZ LAVANDER BLUE
OU3400GMGA LUZ MINT GREEN

LED 10 WATTS 120° ANGLULO APERTURA IP67 GRIS

NUEVO

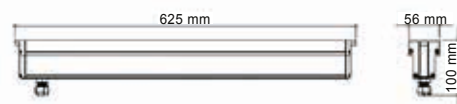

OU3401GLAA LUZ AQUA
OU3401GLCA LUZ CAPRI
OU3401GLEA LUZ ELECTRIC GREEN
OU3401GLJA LUZ LIGHT JADE
OU3401GLVA LUZ LAVANDER BLUE
OU3401GMGA LUZ MINT GREEN

LED 25 WATTS 120° ANGLULO APERTURA IP67 GRIS

NUEVO

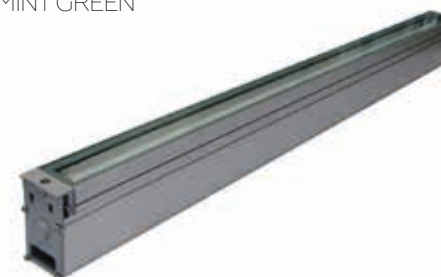
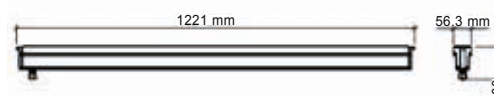

CÓDIGO	MATERIAL DE CUERPO	COLOR	POTENCIA	ALIMENTACIÓN	VIDA ÚTIL (L80)	DRIVER	FUENTE DE LUZ	ÁNGULO DE APERTURA (vxH)	FP	IP	CORTE DE EMPOTRAMIENTO	IK	PESO (KG)
OU3402GLAA	Aluminio	■	50 W	127-277 V	50 000 h	Driver electrónico	LED Integrado	30°	0.95	66	654X81.5X120 mm	9	3.7
OU3402GLJA	Aluminio	■	50 W	127-277 V	50 000 h	Driver electrónico	LED Integrado	30°	0.95	67	654X81.5X120 mm	9	3.7
OU3402GLVA	Aluminio	■	50 W	127-277 V	50 000 h	Driver electrónico	LED Integrado	30°	0.95	67	654X81.5X120 mm	9	3.7
OU3403GLAA	Aluminio	■	50 W	127-277 V	50 000 h	Driver electrónico	LED Integrado	10x40°	0.95	67	654X81.5X120 mm	9	3.7
OU3403GLJA	Aluminio	■	50 W	127-277 V	50 000 h	Driver electrónico	LED Integrado	10x40°	0.95	67	654X81.5X120 mm	9	3.7
OU3403GLVA	Aluminio	■	50 W	127-277 V	50 000 h	Driver electrónico	LED Integrado	10x40°	0.95	67	654X81.5X120 mm	9	3.7
OU3400GLAA	Aluminio	■	10 W	127-277 V	40 000 h	Driver electrónico	LED Integrado	120°	0.95	67	600X60X97 mm	9	1.6
OU3400GLCA	Aluminio	■	10 W	127-277 V	40 000 h	Driver electrónico	LED Integrado	120°	0.95	67	600X60X97 mm	9	1.6
OU3400GLEA	Aluminio	■	10 W	127-277 V	40 000 h	Driver electrónico	LED Integrado	120°	0.95	67	600X60X97 mm	9	1.6
OU3400GLJA	Aluminio	■	10 W	127-277 V	40 000 h	Driver electrónico	LED Integrado	120°	0.95	67	600X60X97 mm	9	1.6
OU3400GLVA	Aluminio	■	10 W	127-277 V	40 000 h	Driver electrónico	LED Integrado	120°	0.95	67	600X60X97 mm	9	1.6
OU3400GMGA	Aluminio	■	10 W	127-277 V	40 000 h	Driver electrónico	LED Integrado	120°	0.95	67	600X60X97 mm	9	1.6
OU3401GLAA	Aluminio	■	25 W	127-277 V	40 000 h	Driver electrónico	LED Integrado	120°	0.95	67	1200X60X97 mm	9	2.5
OU3401GLCA	Aluminio	■	25 W	127-277 V	40 000 h	Driver electrónico	LED Integrado	120°	0.95	67	1200X60X97 mm	9	2.5
OU3401GLEA	Aluminio	■	25 W	127-277 V	40 000 h	Driver electrónico	LED Integrado	120°	0.95	67	1200X60X97 mm	9	2.5
OU3401GLJA	Aluminio	■	25 W	127-277 V	40 000 h	Driver electrónico	LED Integrado	120°	0.95	67	1200X60X97 mm	9	2.5
OU3401GLVA	Aluminio	■	25 W	127-277 V	40 000 h	Driver electrónico	LED Integrado	120°	0.95	67	1200X60X97 mm	9	2.5
OU3401GMGA	Aluminio	■	25 W	127-277 V	40 000 h	Driver electrónico	LED Integrado	120°	0.95	67	1200X60X97 mm	9	2.5

OU7402GLAA LUZ AQUA
OU7402GLVA LUZ LAVANDER BLUE
OU7402GLJA LUZ LIGHT JADE

NUEVO

LED 50 WATTS 30° ANGLULO APERTURA IP65 GRIS

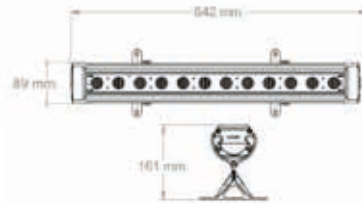

OU7403GLAA LUZ AQUA
OU7403GLVA LUZ LAVANDER BLUE
OU7403GLJA LUZ LIGHT JADE

NUEVO

LED 50 WATTS 10x40° ANGLULO APERTURA IP65 GRIS

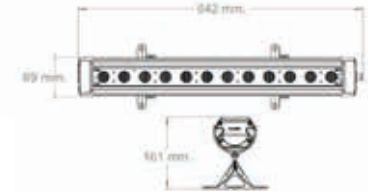

OU7400GLAA LUZ AQUA
OU7400GLCA LUZ CAPRI
OU7400GLEA LUZ ELECTRIC GREEN
OU7400GLJA LUZ LIGHT JADE
OU7400GLVA LUZ LAVANDER BLUE
OU7400GMGA LUZ MINT GREEN

NUEVO

LED 10 WATTS 120° ANGLULO APERTURA IP66 GRIS



OU7401GLAA LUZ AQUA
OU7401GLCA LUZ CAPRI
OU7401GLEA LUZ ELECTRIC GREEN
OU7401GLJA LUZ LIGHT JADE
OU7401GLVA LUZ LAVANDER BLUE
OU7401GMGA LUZ MINT GREEN

NUEVO

LED 25 WATTS 120° ANGLULO APERTURA IP66 GRIS

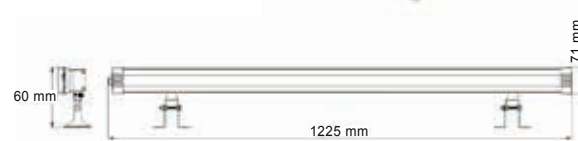

CÓDIGO	MATERIAL DE CUERPO	COLOR	POTENCIA	ALIMENTACIÓN	VIDA ÚTIL (L80)	DRIVER	FUENTE DE LUZ	ÁNGULO DE APERTURA (VxH)	FP	IP	IK	PESO (KG)
OU7402GLAA	Aluminio	■	50 W	127-277 V	50 000 h	Driver electrónico	LED Integrado	30°	0.95	65	9	3.7
OU7402GLVA	Aluminio	■	50 W	127-277 V	50 000 h	Driver electrónico	LED Integrado	30°	0.95	65	9	3.7
OU7402GLJA	Aluminio	■	50 W	127-277 V	50 000 h	Driver electrónico	LED Integrado	30°	0.95	66	9	3.7
OU7403GLAA	Aluminio	■	50 W	127-277 V	50 000 h	Driver electrónico	LED Integrado	10x40°	0.95	65	9	3.7
OU7403GLVA	Aluminio	■	50 W	127-277 V	50 000 h	Driver electrónico	LED Integrado	10x40°	0.95	65	9	3.7
OU7403GLJA	Aluminio	■	50 W	127-277 V	50 000 h	Driver electrónico	LED Integrado	10x40°	0.95	66	9	3.7
OU7400GLAA	Aluminio	■	10 W	127-277 V	40 000 h	Driver electrónico	LED Integrado	120°	0.95	66	9	1.6
OU7400GLCA	Aluminio	■	10 W	127-277 V	40 000 h	Driver electrónico	LED Integrado	120°	0.95	66	9	1.6
OU7400GLEA	Aluminio	■	10 W	127-277 V	40 000 h	Driver electrónico	LED Integrado	120°	0.95	66	9	1.6
OU7400GLJA	Aluminio	■	10 W	127-277 V	40 000 h	Driver electrónico	LED Integrado	120°	0.95	66	9	1.6
OU7400GLVA	Aluminio	■	10 W	127-277 V	40 000 h	Driver electrónico	LED Integrado	120°	0.95	66	9	1.6
OU7400GMGA	Aluminio	■	10 W	127-277 V	40 000 h	Driver electrónico	LED Integrado	120°	0.95	66	9	1.6
OU7401GLAA	Aluminio	■	25 W	127-277 V	40 000 h	Driver electrónico	LED Integrado	120°	0.95	66	9	2.5
OU7401GLCA	Aluminio	■	25 W	127-277 V	40 000 h	Driver electrónico	LED Integrado	120°	0.95	66	9	2.5
OU7401GLEA	Aluminio	■	25 W	127-277 V	40 000 h	Driver electrónico	LED Integrado	120°	0.95	66	9	2.5
OU7401GLJA	Aluminio	■	25 W	127-277 V	40 000 h	Driver electrónico	LED Integrado	120°	0.95	66	9	2.5
OU7401GLVA	Aluminio	■	25 W	127-277 V	40 000 h	Driver electrónico	LED Integrado	120°	0.95	66	9	2.5
OU7401GMGA	Aluminio	■	25 W	127-277 V	40 000 h	Driver electrónico	LED Integrado	120°	0.95	66	9	2.5

*Construlita se reserva el derecho de modificar la información sin previo aviso y no se hace responsable por errores u omisiones en este documento.



DMX

OU3596SRGA LUZ RGB
 LED 50 WATTS 30° ANGLULO APERTURA IP67 SATINADO

NUEVO

OU3597SRGA LUZ RGB
 LED 50 WATTS 10x40° ANGLULO APERTURA IP67 SATINADO

NUEVO

OU3597SMLA
 LED 50 WATTS 37° ANGLULO APERTURA IP67 SATINADO



Construlita DMX solutions guide

Versión: 1.6
 Dic.2019

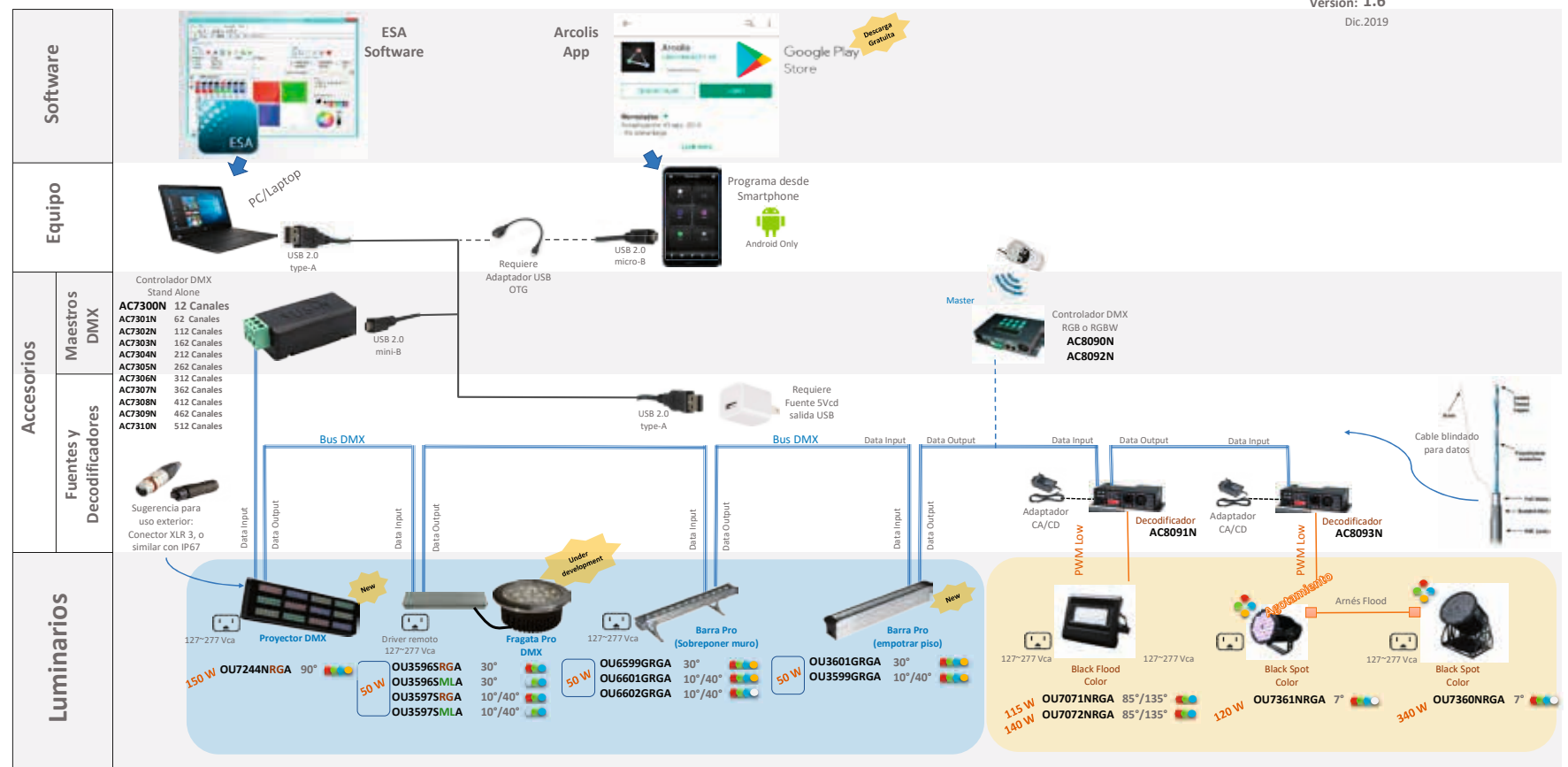

Completamente compatible con protocolo DMX-512
 Complejidad de la instalación eléctrica: baja.
 Nivel 1 Full DMX
 Conexión directa del luminario a la C.A. y al Bus de datos DMX.

Compatibilidad cercana al protocolo DMX-512
 Complejidad de la instalación eléctrica: mediana.
 Nivel 2 Near DMX
 Conocimiento del producto: medio.
 Conexión directa del luminario a la C.A.
 pero requiere decodificador para comunicarse con el Bus de datos DMX.

CÓDIGO	MATERIAL DE CUERPO	COLOR	POTENCIA	ALIMENTACIÓN	VIDA ÚTIL(L80)	DRIVER	FUENTE DE LUZ	ÁNGULO DE APERTURA (VxH)	FP	IP	CORTE DE EMPOTRAMIENTO	IK	PESO (KG)
OU3596SRGA	Aluminio	■	50 W	127-277 V	50 000 h	Driver electrónico	LED Integrado	30°	0.95	67	240X185 mm	9	2.8
OU3597SRGA	Aluminio	■	50 W	127-277 V	50 000 h	Driver electrónico	LED Integrado	10x40°	0.95	67	240X185 mm	9	2.8
OU3597SMLA	Aluminio	■	50 W	127-277 V	50 000 h	Driver electrónico	LED Integrado	30°	0.95	67	240X185 mm	9	2.8

*Construlita se reserva el derecho de modificar la información sin previo aviso y no se hace responsable por errores u omisiones en este documento.

OU3601GRGA

LED 50 WATTS 30° ANGLULO APERTURA IP67 GRIS

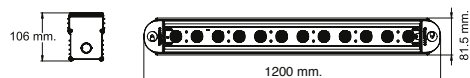

OU3599GRGA

LED 50 WATTS 30° ANGLULO APERTURA IP66 GRIS



NUEVO

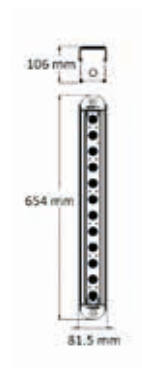

OU6601GRGA

LED 50 WATTS 30° ANGLULO APERTURA IP66 SATINADO

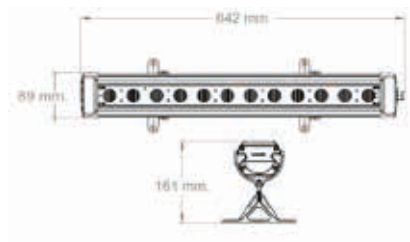

OU6602GRGA

LED 50 WATTS 35x25° ANGLULO APERTURA IP66 GRIS

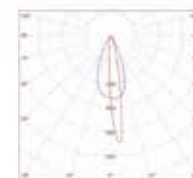

CÓDIGO	MATERIAL DE CUERPO	COLOR	POTENCIA	ALIMENTACIÓN	VIDA ÚTIL(L80)	DRIVER	FUENTE DE LUZ	ÁNGULO DE APERTURA (vxH)	FP	IP	CORTE DE EMPOTRAMIENTO	IK	PESO (KG)
OU3601GRGA	Aluminio	■	50 W	127-277 V	50 000 h	Driver electrónico	LED Integrado	30°	09.5	67	654X81.5X120 mm	9	3.7
OU3599GRGA	Aluminio	■	50 W	127-277 V	50 000 h	Driver electrónico	LED Integrado	30°	0.95	66	654X81.5X120 mm	9	3.7
OU6601GRGA	Aluminio	■	50 W	127-277 V	50 000 h	Driver electrónico	LED Integrado	30°	0.95	66	NA	9	3.7
OU6602GRGA	Aluminio	■	50 W	127-277 V	50 000 h	Driver electrónico	LED Integrado	35x25°	0.95	66	NA	9	3.7

OU7071NRGA

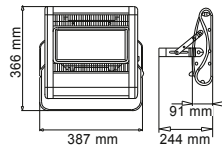
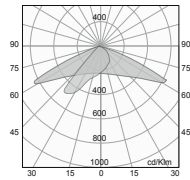

OU7072NRGA

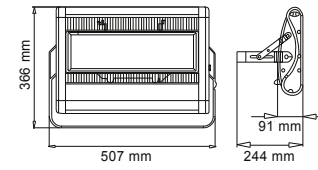
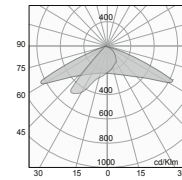

ACCESORIO

AC8090N
Controlador DMX (RGBW)

ACCESORIO

AC8091N
Decodificador DMX-PWM

OU7360NRGA

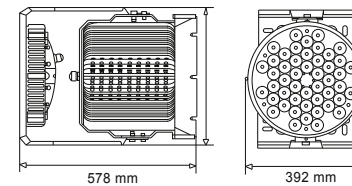
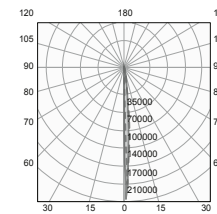

ACCESORIO

AC8092N
Controlador DMX (RGBW)

ACCESORIO

AC8093N
Decodificador DMX-PWM

CÓDIGO	MATERIAL DE CUERPO	COLOR	POTENCIA	ALIMENTACIÓN	VIDA ÚTIL (L80)	DRIVER	FUENTE DE LUZ	ÁNGULO DE APERTURA (VxH)	FP	IP	IK	PESO (KG)
OU7071NRGA	Aluminio	■	115 W	127-277 V	50 000 h	Driver electrónico	LED Integrado	85x135°	0.9	65	7	10.4
OU7072NRGA	Aluminio	■	140 W	127-277 V	50 000 h	Driver electrónico	LED Integrado	85x135°	0.85	65	7	12.6
OU7360NRGA	Aluminio	■	340 W	127-277 V	50 000 h	Driver electrónico	LED Integrado	7°	0.7	65	7	31.8

**ACABADO
BRONCE**



OU7012C00K

LED 40 WATTS IP65 BRONCE

NUEVO

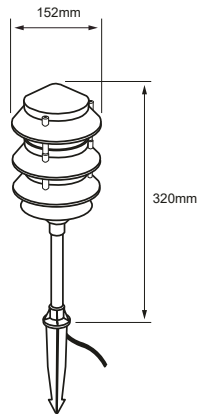

OU9011CBCF

LED 3 WATTS 65 LUMENS 2700K 60° ANGULO APERTURA IP65 BRONCE

NUEVO

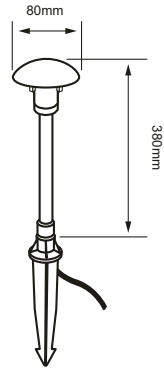
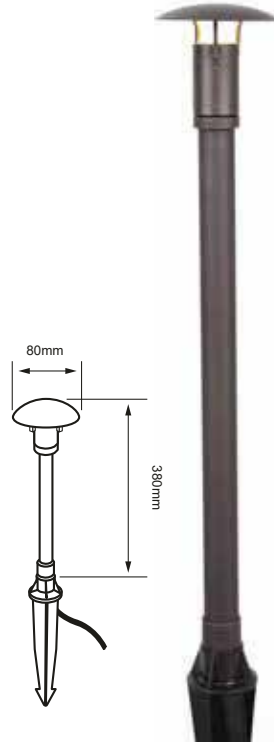

OU9012C00K

LED 40 WATTS IP65 BRONCE

NUEVO

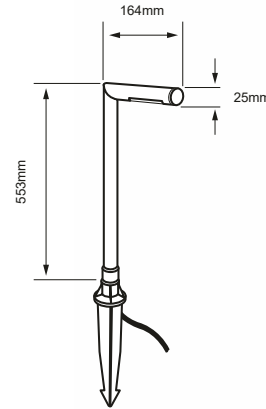
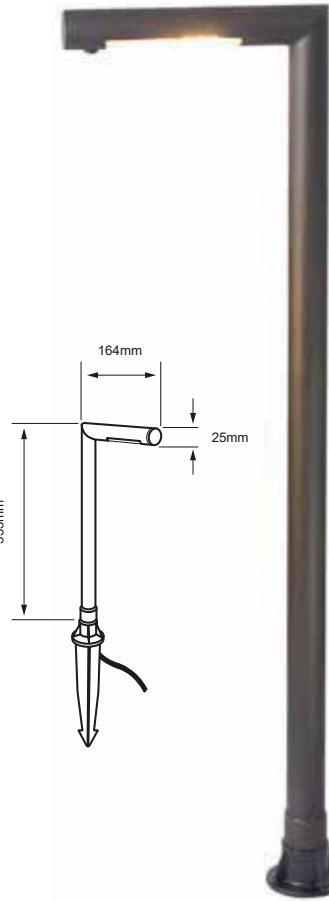

OU9010C00K

LED 40 WATTS IP65 BRONCE

NUEVO

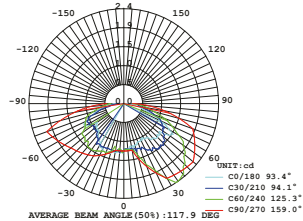
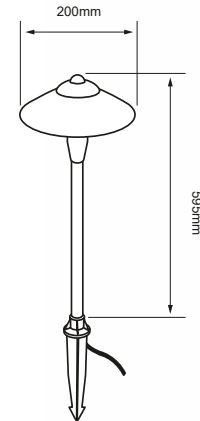
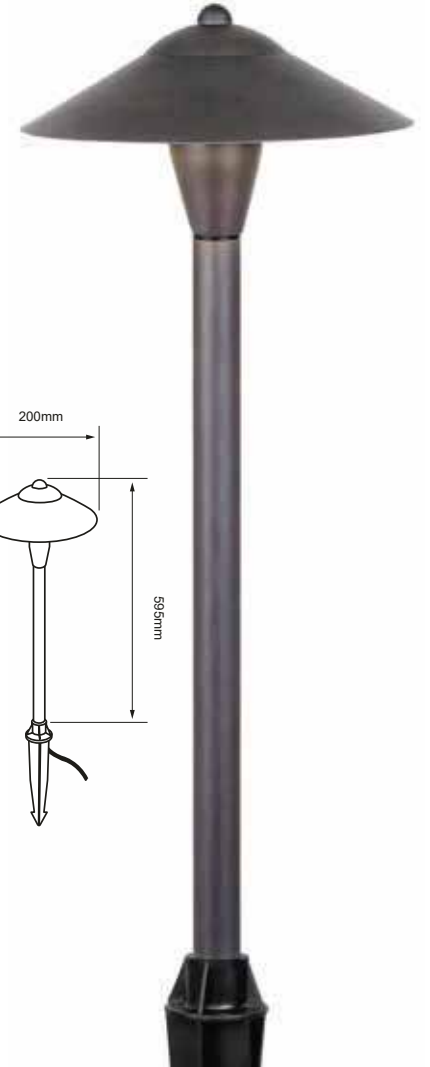

ACCESORIO SOBREPONER AC7600C

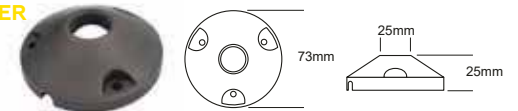

CÓDIGO	MATERIAL DE CUERPO	COLOR	POTENCIA	FLUJO LUMINOSO	ALIMENTACIÓN	TCC	VIDA ÚTIL (L80)	FUENTE DE LUZ	ÁNGULO DE APERTURA (VxH)	IRC	FP	IP	PESO (KG)
OU7012C00K	Aluminio	■	40 W MAX	-	100-240 V ~	-	-	No Incluye Lámpara	-	-	-	65	0.835
OU9011CBCF	Latón	■	3 W	65 lm	12 VCD	■ 2700K	25000 h	LED Integrado	60°	80	0.7	65	0.469
OU9012C00K	Latón	■	40 W	-	100-240 V ~	-	-	No Incluye Lámpara	-	-	-	65	0.585
OU9010C00K	Latón	■	40 W	-	100-240 V ~	-	-	No Incluye Lámpara	-	-	-	65	0.954

OU6026C00K

LED 100 WATTS IP65 BRONCE

NUEVO

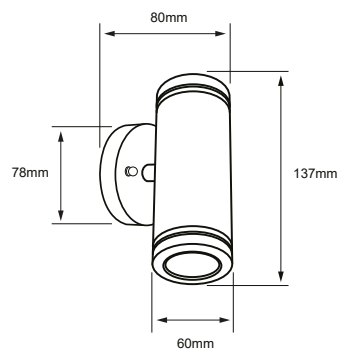

OU3022C00K

LED 50 WATTS IP65 BRONCE

NUEVO

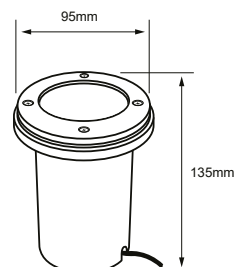

OU3023C00K

LED 50 WATTS IP65 BRONCE

NUEVO

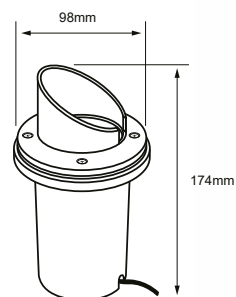

CÓDIGO	MATERIAL DE CUERPO	COLOR	POTENCIA	FLUJO LUMINOSO	ALIMENTACIÓN	TCC	VIDA ÚTIL (L80)	DRIVER	FUENTE DE LUZ	ÁNGULO DE APERTURA (VxH)	IRC	FP	IP	CORTE DE EMPOTRAMIENTO	IK	PESO (KG)
OU6026C00K	Latón	■	100 W máx.	-	100-240 V ~	-	-	No Incluye Lámpara	-	-	-	-	65	-	-	0.87
OU3022C00K	Latón	■	50 W máx.	-	100-240 V ~	-	-	-	No Incluye Lámpara	-	-	-	65	-	-	0.44
OU3023C00K	Latón	■	50 W máx.	-	100-240 V ~	-	-	-	No Incluye Lámpara	-	-	-	65	-	-	0.48

OU7014C00K

LED 50 WATTS IP65 BRONCE

NUEVO

OU7013C00K

LED 50 WATTS IP65 BRONCE

NUEVO

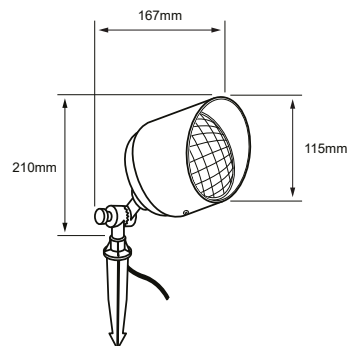
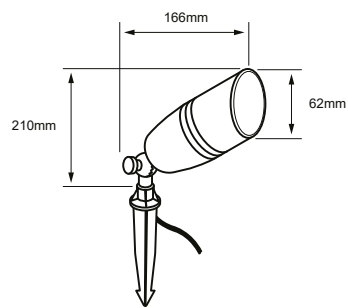

CÓDIGO	MATERIAL DE CUERPO	COLOR	POTENCIA	FLUJO LUMINOSO	ALIMENTACIÓN	TCC	VIDA ÚTIL (L80)	DRIVER	FUENTE DE LUZ	ÁNGULO DE APERTURA (VxH)	IRC	FP	IP	CORTE DE EMPOTRAMIENTO	IK	PESO (KG)
OU7014C00K	Laton	■	50 W máx	-	100-240 V ~	-	-	-	No Incluye Lámpara	-	-	-	65			0.78
OU7013C00K	Laton	■	50 W máx	-	100-240 V ~	-	-	-	No Incluye Lámpara	-	-	-	65			0.51

WALLPACK



OU6802NBFA

LED 70 WATTS 9140 LUMENS 5000K Tipo3 ANGULO APERTURA IP65 NEGRO

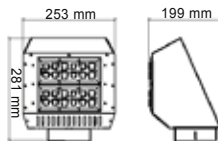
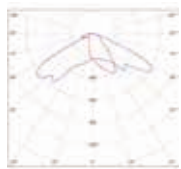

OU6800NBFA

LED 45 WATTS 4570 LUMENS 5000K Tipo3 ANGULO APERTURA IP65 NEGRO

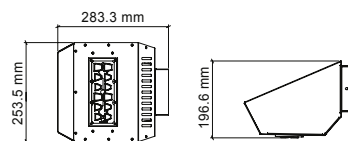
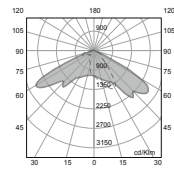

OU6084NBFA

LED 70 WATTS 9800 LUMENS 5000K 100° ANGULO APERTURA IP65 NEGRO

NUEVO

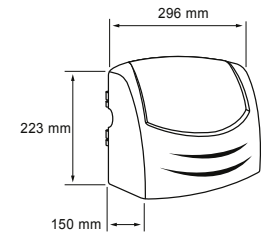
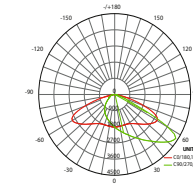

OU6801SBFA

LED 45 WATTS 4570 LUMENS 5000K Tipo3 ANGULO APERTURA IP65 SATINADO

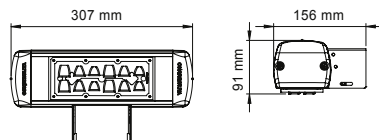
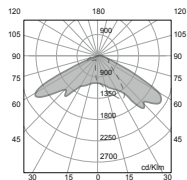

OU6803SBFA

LED 88 WATTS 9140 LUMENS 5000K Tipo3 ANGULO APERTURA IP65 SATINADO

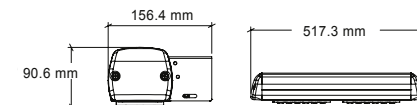
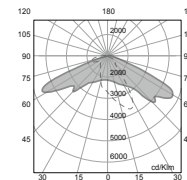

CÓDIGO	MATERIAL DE CUERPO	COLOR	POTENCIA	FLUJO LUMINOSO	ALIMENTACIÓN	TCC	VIDA ÚTIL (L80)	DRIVER	FUENTE DE LUZ	ÁNGULO DE APERTURA (VxH)	IRC	FP	IP	IK	PESO (KG)
OU6802NBFA	Acero	■	70 W	9140 lm	127-277 V	■ 5 000 K	50 000 h	Driver electrónico	LED Integrado	Tipo 3	70	0.9	65	6	3.6
OU6800NBFA	Acero	■	45 W	4570 lm	127-277 V	■ 5 000 K	50 000 h	Driver electrónico	LED Integrado	Tipo 3	70	0.9	65	6	2.5
OU6084NBFA	Aluminio	■	70 W	9800 lm	100-277V ~	■ 5 000 K	30 000 h	Driver electrónico	LED Integrado	100°	70	0.9	65	10	4
OU6801SBFA	Aluminio	■	45 W	4570 lm	127-277 V	■ 5 000 K	50 000 h	Driver electrónico	LED Integrado	Tipo 3	70	0.9	65	6	1.7
OU6803SBFA	Aluminio	■	88 W	9140 lm	127-277 V	■ 5 000 K	50 000 h	Driver electrónico	LED Integrado	Tipo 3	70	0.9	65	6	3

OU6085FBNA

LED 90 WATTS 8800 LUMENS 4000K 110° ANGLULO APERTURA IP65 GRAFITO

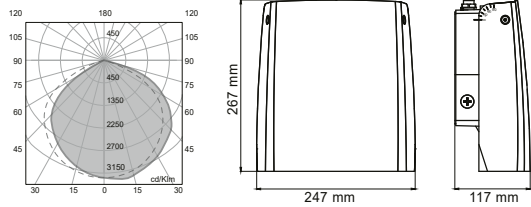

OU6082FBNA

LED 38 WATTS 2880 LUMENS 4000K 70x100° ANGLULO APERTURA IP65 GRAFITO

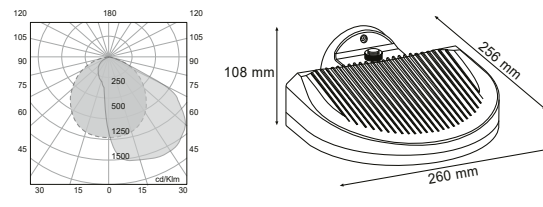

OU6083FBNA

LED 72 WATTS 5850 LUMENS 4000K 70x100° ANGLULO APERTURA IP65 GRAFITO

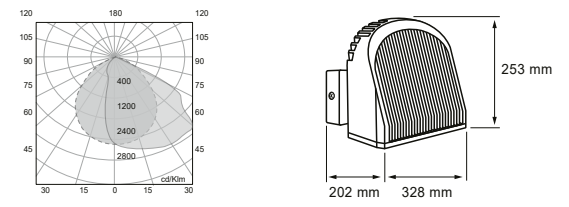

OU6086CBFA

LED 40 WATTS 4450 LUMENS 5000K 134° ANGLULO APERTURA IP65 CAFÉ

NUEVO

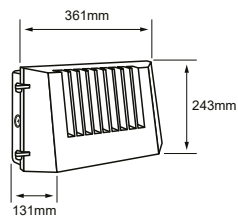
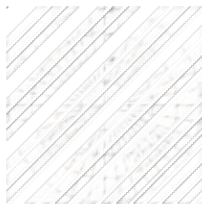

OU6087CBFA

LED 80 WATTS 8800 LUMENS 5000K 134° ANGLULO APERTURA IP65 CAFÉ

NUEVO

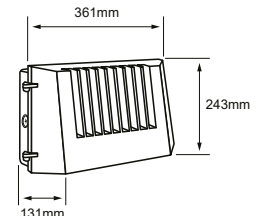
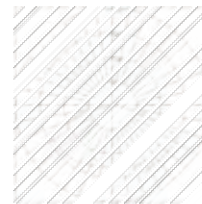

CÓDIGO	MATERIAL DE CUERPO	COLOR	POTENCIA	FLUJO LUMINOSO	ALIMENTACIÓN	TCC	VIDA ÚTIL (L80)	DRIVER	FUENTE DE LUZ	ÁNGULO DE APERTURA (VxH)	IRC	FP	IP	IK	PESO (KG)
OU6085FBNA	Aluminio	■	90 W	8800 lm	127-277 V	□ 4 000 K	50 000 h	Driver electrónico	LED Integrado	110°	80	0.9	65	6	3.1
OU6082FBNA	Aluminio	■	38 W	2880 lm	127-277 V	□ 4 000 K	50 000 h	Driver electrónico	LED Integrado	70x100°	80	0.9	65	6	2.12
OU6083FBNA	Aluminio	■	72 W	5850 lm	127-277 V	□ 4 000 K	50 000 h	Driver electrónico	LED Integrado	70x100°	80	0.9	65	6	5.45
OU6086CBFA	Aluminio	■	40 W	4450 lm	100-277 V ~	□ 5 000 K	54000 h	Driver electrónico	LED Integrado	134°	80	0.9	65	8	3.2
OU6087CBFA	Aluminio	■	80 W	8800 lm	100-277 V ~	□ 5 000 K	54000 h	Driver electrónico	LED Integrado	134°	80	0.9	65	8	3.2



ARBOTANTE



OU6091FBCB

LED 10 WATTS 845 LUMENS 3000K 80° ANGLULO APERTURA IP65 GRAFITO

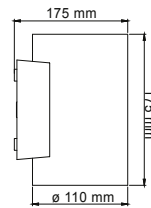
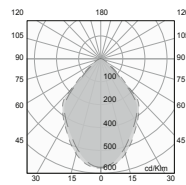

OU6092FBCB

LED 2x10 WATTS 845 LUMENS 3000K 80° ANGLULO APERTURA IP65 GRAFITO

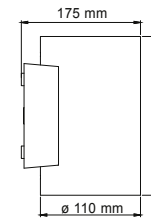
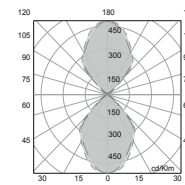

OU6025FBCB

LED 37x2 WATTS 6500 LUMENS 3000K 40° ANGLULO APERTURA IP65 GRAFITO

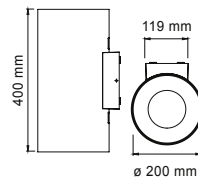
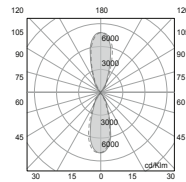

OU6049NBCB

LED 8 WATTS 427 LUMENS 3000K 45° ANGLULO APERTURA IP65 NEGRO

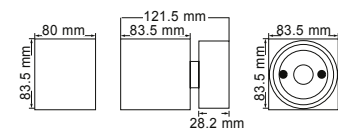
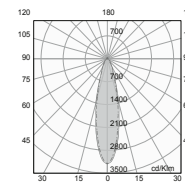

CÓDIGO	MATERIAL DE CUERPO	COLOR	POTENCIA	FLUJO LUMINOSO	ALIMENTACIÓN	TCC	VIDA ÚTIL(L80)	DRIVER	FUENTE DE LUZ	ÁNGULO DE APERTURA (vxH)	IRC	FP	IP	IK	PESO (KG)
OU6091FBCB	Aluminio	■	10 W	845 lm	127-220 V	3 000 K	50 000 h	Driver electrónico	LED Integrado	80°	80	0.9	65	4	1
OU6092FBCB	Aluminio	■	2X10W	845 lm	127-220 V	3 000 K	50 000 h	Driver electrónico	LED Integrado	80°	80	0.95	65	4	1
OU6025FBCB	Aluminio	■	2X37 W	6500 lm	127-220 V	3 000 K	50 000 h	Driver electrónico	LED Integrado	40°	80	0.9	65	4	2.5
OU6049NBCB	Aluminio	■	8 W	427 lm	127-220 V	3 000 K	30 000 h	Driver electrónico	LED Integrado	45°	80	0.9	65	4	0.955

OU6074NBCA

LED 13 WATTS 960 LUMENS 3000K 14° ANGULO APERTURA IP65 NEGRO

NUEVO

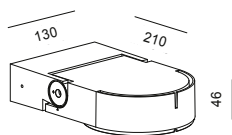
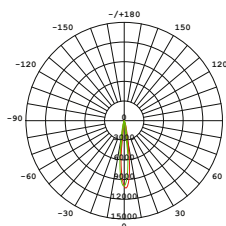
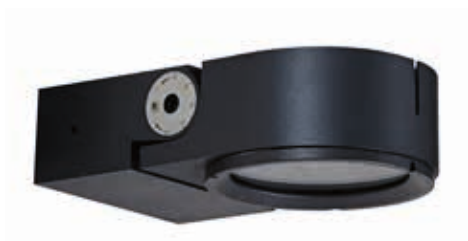

OU6075NBCA

LED 28 WATTS 1620 LUMENS 3000K 14° ANGULO APERTURA IP65 NEGRO

NUEVO

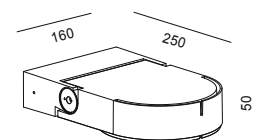
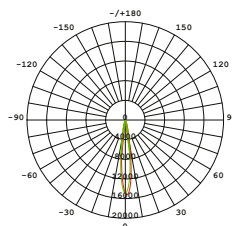
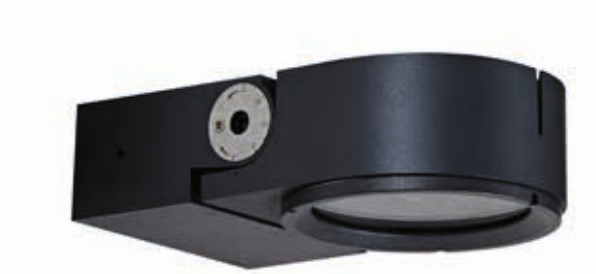

OU6095FBNB

LED 11 WATTS 625 LUMENS 4000K 60x180° ANGULO APERTURA IP54 GRAFITO

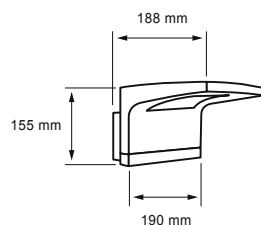
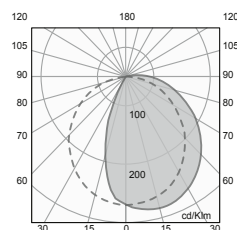

OU6080GBNB

LED 14 WATTS 1170 LUMENS 4000K 100/90° ANGULO APERTURA IP65 GRIS

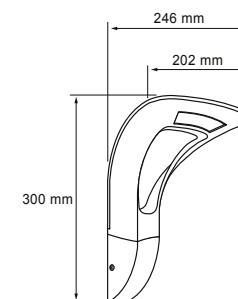
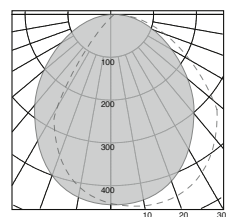

CÓDIGO	MATERIAL DE CUERPO	COLOR	POTENCIA	FLUJO LUMINOSO	ALIMENTACIÓN	TCC	VIDA ÚTIL(L80)	DRIVER	FUENTE DE LUZ	ÁNGULO DE APERTURA (vxH)	IRC	FP	IP	IK	PESO (KG)
OU6074NBCA	Aleación Aluminio	■	13 W	960 lm	100-277 V ~	3 000 K	30000 h	Driver LED	LED Integrado	14°	90	0.8	65	7	1.4
OU6075NBCA	Aleación Aluminio	■	28 W	1620 lm	100-277 V ~	3 000 K	30000 h	Driver LED	LED Integrado	14°	90	0.8	65	7	2
OU6095FBNB	Aluminio	■	11 W	625 lm	127-220 V	4 000 K	50 000 h	Driver electrónico	LED Integrado	60x180°	80	0.9	54	5	2.8
OU6080GBNB	Aluminio	■	14 W	1170 lm	127-220 V	4 000 K	35 000 h	Driver electrónico	LED Integrado	100/90°	80	0.9	65	5	1.25

OU6055BBCB

LED 11 WATTS 750 LUMENS 3000K AJUSTABLE ANGULO APERTURA IP54 BLANCO

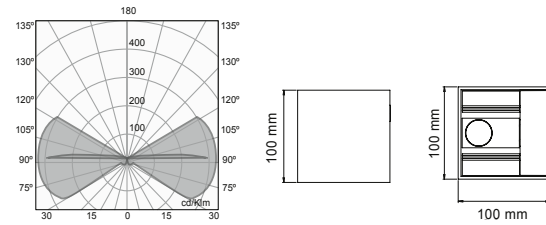

OU6053BBCB

LED 5.5X2 WATTS 590 LUMENS 3000K 60° ANGULO APERTURA IP54 BLANCO

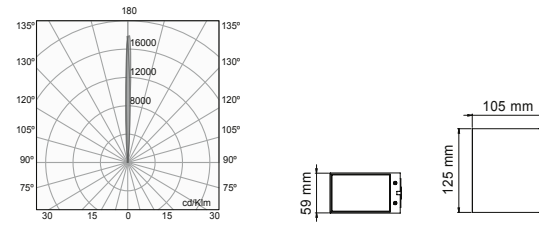

OU6039GBCD

LED 9 WATTS 530 LUMENS 3000K 120° ANGULO APERTURA IP65 GRIS

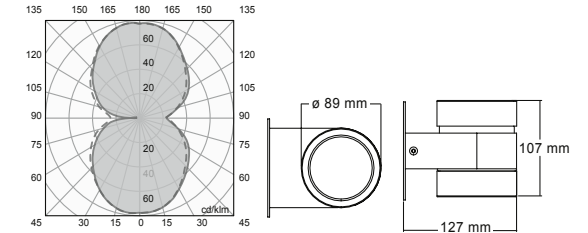

EXTERIOR / ARBOTANTE DE TECHO / SOBREPONER

OU4090FBNB

LED 38 WATTS 2900 LUMENS 4000K 60° ANGULO APERTURA IP65 GRAFITO

OU4090FBCB

LED 38 WATTS 2900 LUMENS 3000K 60° ANGULO APERTURA IP65 GRAFITO

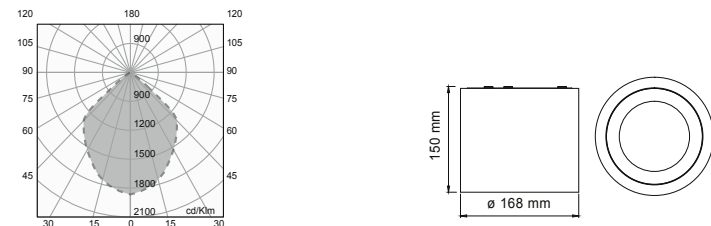

CÓDIGO	MATERIAL DE CUERPO	COLOR	POTENCIA	FLUJO LUMINOSO	ALIMENTACIÓN	TCC	VIDA ÚTIL (L80)	DRIVER	FUENTE DE LUZ	ÁNGULO DE APERTURA (VxH)	IRC	FP	IP	IK	PESO (KG)
OU6055BBCB	Aluminio	□	11 W	750 lm	127-220 V	3 000 K	30 000 h	Driver electrónico	LED Integrado	AJUSTABLE	80	0.9	54	6	1.2
OU6053BBCB	Aluminio	□	2X5.5 W	590 lm	127-220 V	3 000 K	30 000 h	Driver electrónico	LED Integrado	60°	80	0.8	54	6	1.5
OU6039GBCD	Aluminio	■	9 W	530 lm	127 V	3 000 K	50 000 h	-	LED Integrado	120°	80	0.95	65	5	0.735
OU4090FBNB	Aluminio	■	38 W	2900 lm	127-220 V	4 000 K	50 000 h	Driver electrónico	LED Integrado	60°	80	0.9	65	4	2.2
OU4090FBCB	Aluminio	■	38 W	2900 lm	127-220 V	3 000 K	50 000 h	Driver electrónico	LED Integrado	60°	80	0.9	65	4	1

A photograph of a modern house at night. The house features a prominent wall of stacked stone and a large glass door with a black frame. The interior lights are on, and the door is illuminated from within. The house is set against a backdrop of trees and a dark sky. A large black circle is overlaid on the left side of the image, partially obscuring the house and the sky.

MARKO

OU6610GBCA

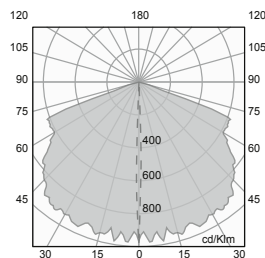
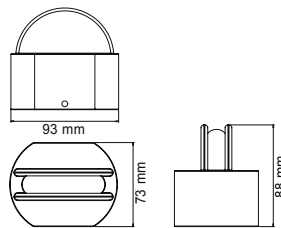

OU6611BBCA

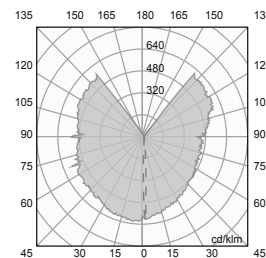
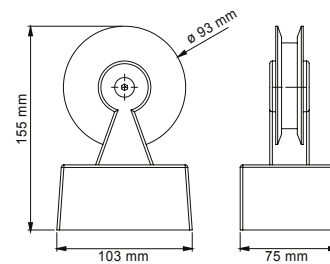

OU6612NRGG

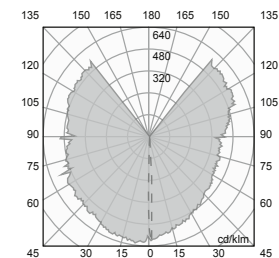
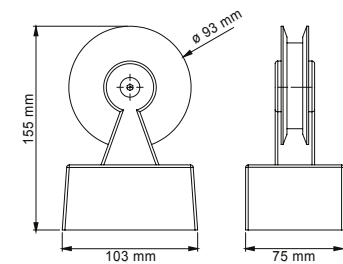

CÓDIGO	MATERIAL DE CUERPO	COLOR	POTENCIA	FLUJO LUMINOSO	ALIMENTACIÓN	TCC	VIDA ÚTIL (L80)	DRIVER	FUENTE DE LUZ	ÁNGULO DE APERTURA (VxH)	IRC	FP	IP	IK	PESO (KG)
OU6610GBCA	Aluminio	■	9 W	720 lm	127-277 V	■ 3 000 K	30 000 h	Driver electrónico	LED Integrado	360°	80	0.9	65	5	0.37
OU6611BBCA	Aluminio	□	9 W	110 lm	127-277 V	■ 3 000 K	30 000 h	Driver electrónico	LED Integrado	360°	80	0.9	65	5	0.37
OU6612NRGG	Aluminio	■	3 W	-	24 V	■ RGB	30 000 h	Driver electrónico	LED Integrado	360°	80	0.9	65	5	0.37



**CORTESÍA
MURO**

OU2012NBCG

LED 2.8 WATTS 20 LUMENS 3000K 103° ANGULO APERTURA IP67 NEGRO

NUEVO



* Housing: 44mm diámetro - 70mm alto

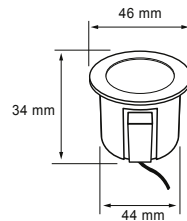
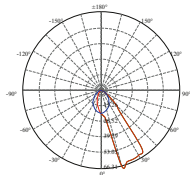

OU2019NBCG

LED 1.4 WATTS 15 LUMENS 3000K 103° ANGULO APERTURA IP67 NEGRO

NUEVO



* Housing: 44mm diámetro - 70mm alto

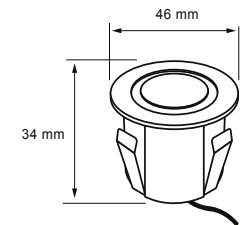

OU2013BBCB

LED 3 WATTS 70 LUMENS 3000K 26° ANGULO APERTURA IP65 BLANCO

NUEVO

OU2013NBCB

LED 3 WATTS 70 LUMENS 3000K 26° ANGULO APERTURA IP65 NEGRO

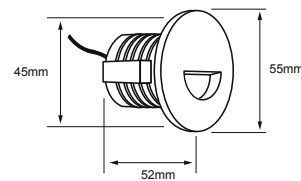
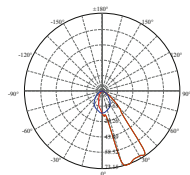
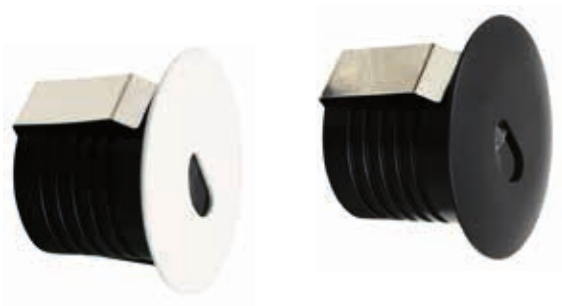

OU2014BBCB

LED 3 WATTS 70 LUMENS 3000K 26° ANGULO APERTURA IP65 BLANCO

NUEVO

OU2014NBCB

LED 3 WATTS 70 LUMENS 3000K 26° ANGULO APERTURA IP65 NEGRO

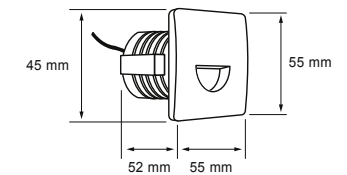
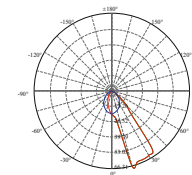

CÓDIGO	MATERIAL DE CUERPO	COLOR	POTENCIA	FLUJO LUMINOSO	ALIMENTACIÓN	TCC	VIDA ÚTIL (L80)	DRIVER	FUENTE DE LUZ	ÁNGULO DE APERTURA (VxH)	IRC	FP	IP	CORTE DE EMPOTRAMIENTO	IK	PESO (KG)
OU2012NBCG	Aluminio	■	2.8 W	20 lm	24 VDC	3 000 K	30 000 h	Driver electrónico	LED Integrado	103°	80	0.5	67	42 mm	6	0.12
OU2019NBCG	Aluminio	■	1.4 W	15 lm	24 VDC	3 000 K	30 000 h	Driver electrónico	LED Integrado	103°	80	0.5	67	42 mm	6	0.12
OU2013BBCB	Aluminio	□	3 W	70 lm	100-240V ~	3 000 K	30 000 h	Driver electrónico	LED Integrado	26°	80	0.5	65	45 mm	8	0.19
OU2013NBCB	Aluminio	■	3 W	70 lm	100-240V ~	3 000 K	30 000 h	Driver electrónico	LED Integrado	26°	80	0.5	65	45 mm	8	0.19
OU2014BBCB	Aluminio	□	3 W	70 lm	100-240V ~	3 000 K	30 000 h	Driver electrónico	LED Integrado	26°	80	0.5	65	45 mm	8	0.19
OU2014NBCB	Aluminio	■	3 W	70 lm	100-240V ~	3 000 K	30 000 h	Driver electrónico	LED Integrado	26°	80	0.5	65	45 mm	8	0.19

OU6012SBCF

LED 1 WATTS 65 LUMENS 2700K 120° ANGULO APERTURA IP65 SOMBRA

NUEVO

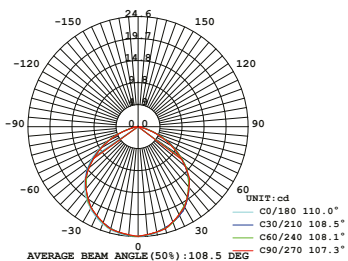
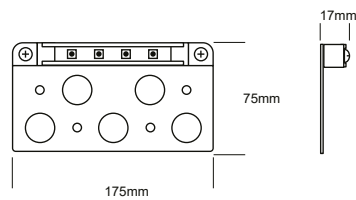

OU6014SBCF

LED 1.5 WATTS 120 LUMENS 2700K 120° ANGULO APERTURA IP65 SOMBRA

NUEVO

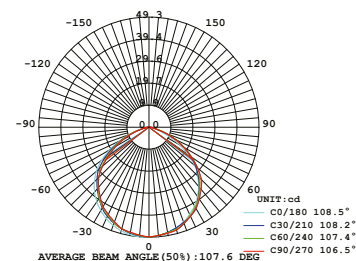
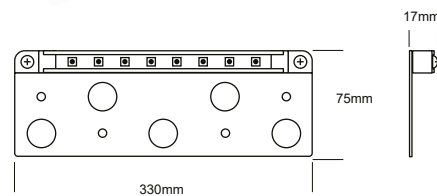

OU6013SBCF

LED 2.5 WATTS 200 LUMENS 2700K 120° ANGULO APERTURA IP65 SOMBRA

NUEVO

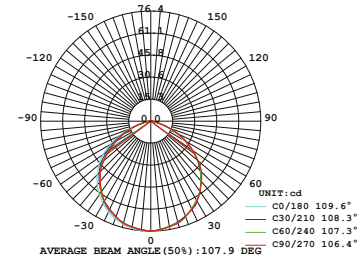
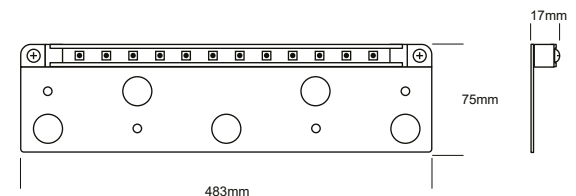

CÓDIGO	MATERIAL DE CUERPO	COLOR	POTENCIA	FLUJO LUMINOSO	ALIMENTACIÓN	TCC	VIDA ÚTIL (L80)	FUENTE DE LUZ	ÁNGULO DE APERTURA (vxH)	IRC	FP	IP	PESO (KG)
OU6012SBCF	Aluminio/acero	■	1 W	65 lm	12 VCD	■ 2700K	25000 h	LED Integrado	120°	80	0.8	65	0.247
OU6014SBCF	Aluminio/acero	■	1.5 W	120 lm	12 VCD	■ 2700K	25000 h	LED Integrado	120°	80	0.8	65	0.425
OU6013SBCF	Aluminio/acero	■	2.5 W	200 lm	12 VCD	■ 2700K	25000 h	LED Integrado	120°	80	0.8	65	0.578

OU2015NBCA

LED 3 WATTS 40 LUMENS 3000K 35° ANGLULO APERTURA IP65 NEGRO

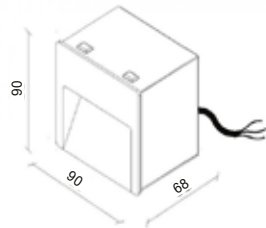
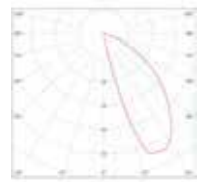

OU2017NBCA

LED 3 WATTS 20 LUMENS 3000K 45° ANGLULO APERTURA IP65 NEGRO

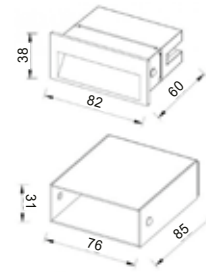
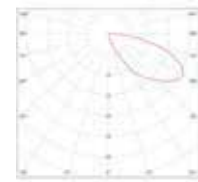

OU2016NBCA

LED 6 WATTS 60 LUMENS 3000K 45° ANGLULO APERTURA IP65 NEGRO

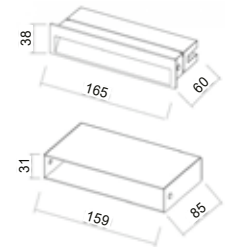
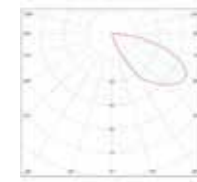

OU2100NBCB

LED 24 WATTS 420 LUMENS 3000K 57° ANGLULO APERTURA IP54 NEGRO

NUEVO

* Incluye Housing

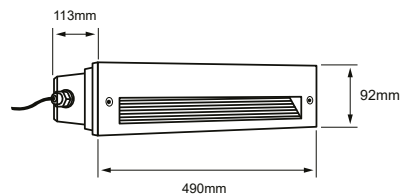
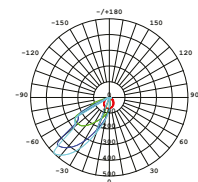

OU2101NBCB

LED 19 WATTS 770 LUMENS 3000K 97° ANGLULO APERTURA IP54 NEGRO

NUEVO

* Incluye Housing

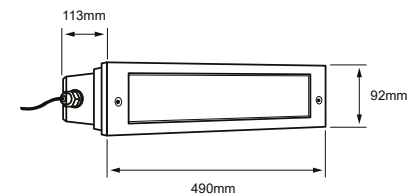
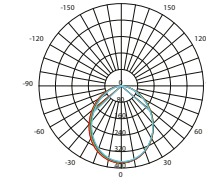

CÓDIGO	MATERIAL DE CUERPO	COLOR	POTENCIA	FLUJO LUMINOSO	ALIMENTACIÓN	TCC	VIDA ÚTIL (L80)	DRIVER	FUENTE DE LUZ	ÁNGULO DE APERTURA (vxH)	IRC	FP	IP	CORTE DE EMPOTRAMIENTO	IK	PESO (KG)
OU2015NBCA	Aluminio	■	3 W	40 lm	127-277 V	3 000 K	25 000 h	Driver electrónico	LED Integrado	35°	80	0.6	65	NA	9	0.15
OU2017NBCA	Aluminio	■	3 W	20 lm	127-277 V	3 000 K	25 000 h	Driver electrónico	LED Integrado	45°	80	0.6	65	NA	9	0.18
OU2016NBCA	Aluminio	■	6 W	60 lm	127-277 V	3 000 K	25 000 h	Driver electrónico	LED Integrado	45°	80	0.6	65	NA	9	0.215
OU2100NBCB	Aluminio	■	24 W	420 lm	100-240 V ~	3 000 K	15000 h	Driver LED	LED Integrado	57°	80	0.9	54	485 x 80 mm	5	1.68
OU2101NBCB	Aluminio	■	19 W	770 lm	100-240 V ~	3 000 K	15000 h	Driver LED	LED Integrado	97°	80	0.9	54	485 x 80 mm	5	1.71



OU2018NBCA

LED 4 WATTS 60 LUMENS 3000K 60° ANGLULO APERTURA IP65 GRIS

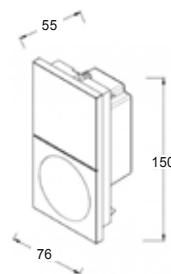
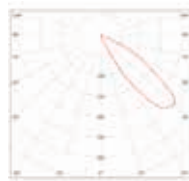

RE6008GBCD

LED 11 WATTS 395 LUMENS 3000K 110° ANGLULO APERTURA IP54 GRIS

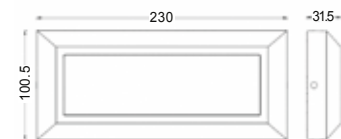
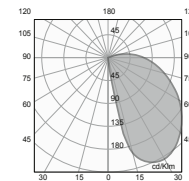

CÓDIGO	MATERIAL DE CUERPO	COLOR	POTENCIA	FLUJO LUMINOSO	ALIMENTACIÓN	TCC	VIDA ÚTIL (L80)	DRIVER	FUENTE DE LUZ	ÁNGULO DE APERTURA (VxH)	IRC	FP	IP	CORTE DE EMPOTRAMIENTO	IK	PESO (KG)
OU2018NBCA	Aluminio	■ Gris	4 W	60 lm	127-277 V	■ 3 000 K	25 000 h	Driver electrónico	LED Integrado	60°	80	0.6	65	NA	9	0.5
RE6008GBCD	Aluminio	■ Gris	11 W	395 lm	127 V	■ 3 000 K	25 000 h	Driver electrónico	LED Integrado	110°	80	0.6	54	NA	9	0.45

OU2006BBCB

LED 8 WATTS 172 LUMENS 3000K 65° ANGLULO APERTURA IP65 BLANCO

OU2006GBCB

LED 8 WATTS 172 LUMENS 3000K 65° ANGLULO APERTURA IP65 GRIS

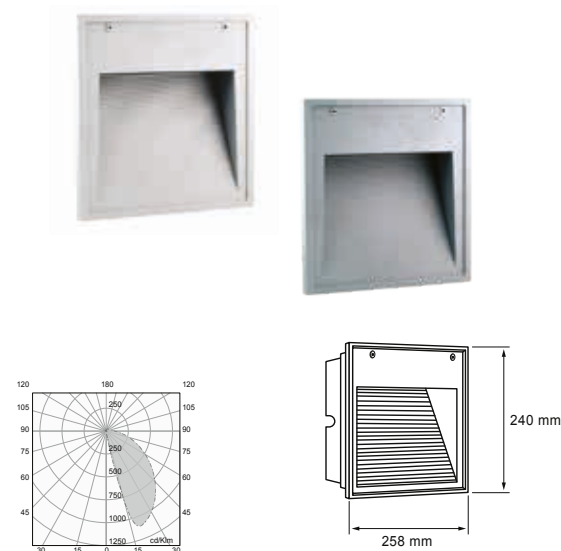

RE2003GBCD

LED 4.5 WATTS 100 LUMENS 3000K 60° ANGLULO APERTURA IP65 GRIS

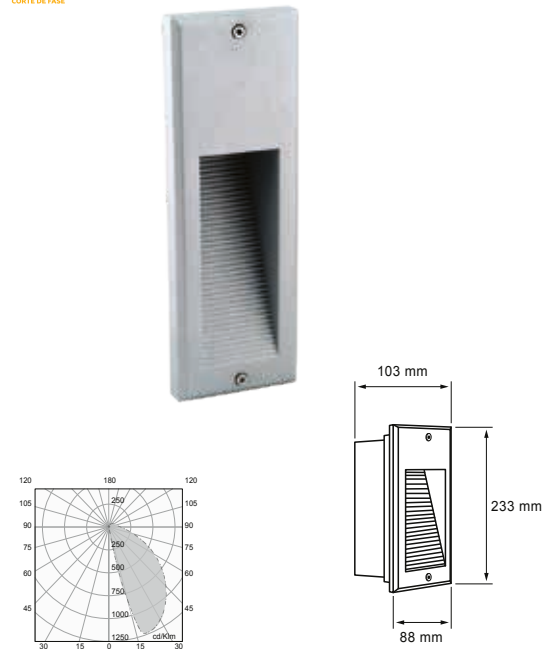

RE2010GBCD

LED 4.5 WATTS 66 LUMENS 3000K 48° ANGLULO APERTURA IP65 GRIS

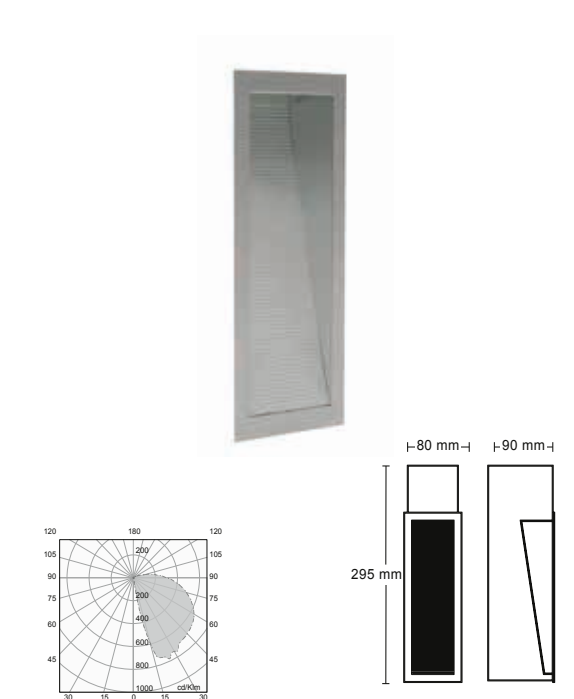

OU2008GBCB

LED 0.7 WATTS 24 LUMENS 3000K 50° ANGLULO APERTURA IP65 GRIS

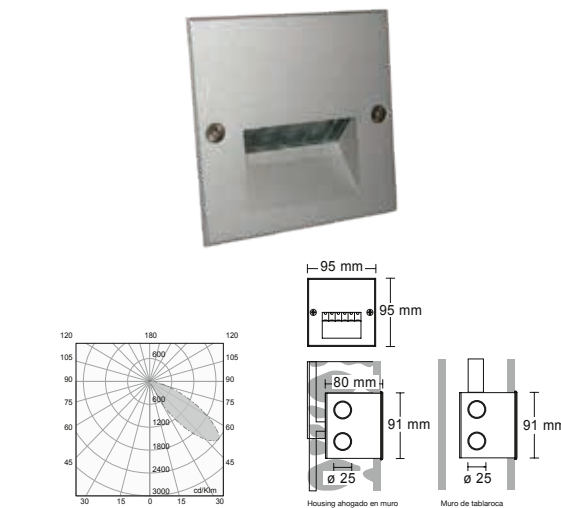

OU2007GBCB

LED 0.7 WATTS 17 LUMENS 3000K 50° ANGLULO APERTURA IP65 GRIS

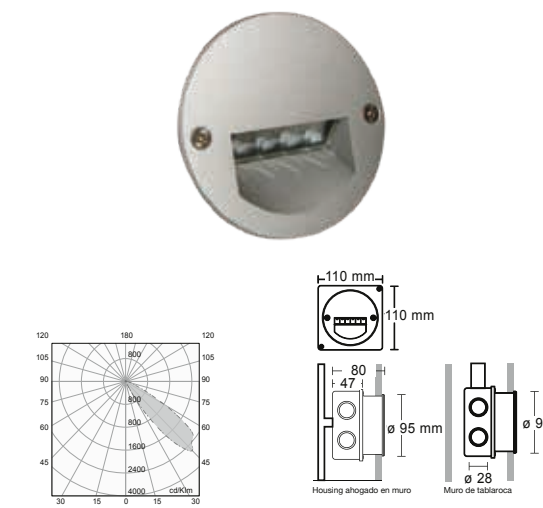

OU2009GBCB

LED 1.5 WATTS 126 LUMENS 3000K 125° ANGLULO APERTURA IP65 GRIS

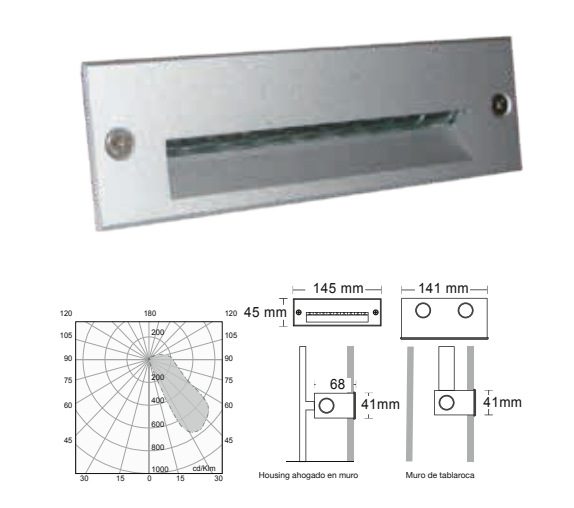

CÓDIGO	MATERIAL DE CUERPO	COLOR	POTENCIA	FLUJO LUMINOSO	ALIMENTACIÓN	TCC	VIDA ÚTIL (L80)	DRIVER	FUENTE DE LUZ	ÁNGULO DE APERTURA (VxH)	IRC	FP	IP	IK	PESO (KG)
OU2006BBCB	Aluminio	Blanco	8 W	172 lm	127-220 V	3 000 K	25 000 h	Driver electrónico	LED Integrado	65°	70	0.9	65	9	2.5
OU2006GBCB	Aluminio	Gris	8 W	172 lm	127-220 V	3 000 K	25 000 h	Driver electrónico	LED Integrado	65°	70	0.9	65	9	2.5
RE2003GBCD	Aluminio	Gris	4.5 W	100 lm	127 V	3 000 K	25 000 h	Driver electrónico	LED Integrado	60°	80	0.9	65	9	1.2
RE2010GBCD	Aluminio	Gris	4.5 W	66 lm	127 V	3 000 K	25 000 h	Driver electrónico	LED Integrado	48°	80	0.9	65	9	1.165
OU2008GBCB	Aluminio	Gris	0.7 W	24 lm	127-220 V	3 000 K	25 000 h	Driver electrónico	LED Integrado	50°	80	0.5	65	9	0.4
OU2007GBCB	Aluminio	Gris	0.7 W	17 lm	127-220 V	3 000 K	25 000 h	Driver electrónico	LED Integrado	50°	80	0.5	65	9	0.33
OU2009GBCB	Aluminio	Gris	1.5 W	126 lm	127-220 V	3 000 K	25 000 h	Driver electrónico	LED Integrado	125°	80	0.5	65	9	0.34

*Construlita se reserva el derecho de modificar la información sin previo aviso y no se hace responsable por errores u omisiones en este documento.

**POSTE
DECORATIVO**



OU9045FBNB

LED 50 WATTS 2360 LUMENS 4000K 100° ANGULO APERTURA IP65 GRAFITO



OU9051GBNA

LED 66 WATTS 4800 LUMENS 4000K 180° ANGULO APERTURA IP65 GRIS



OU9905GNCA

LED 50 WATTS 2600 LUMENS 4000K 120° ANGULO APERTURA IP65 GRIS

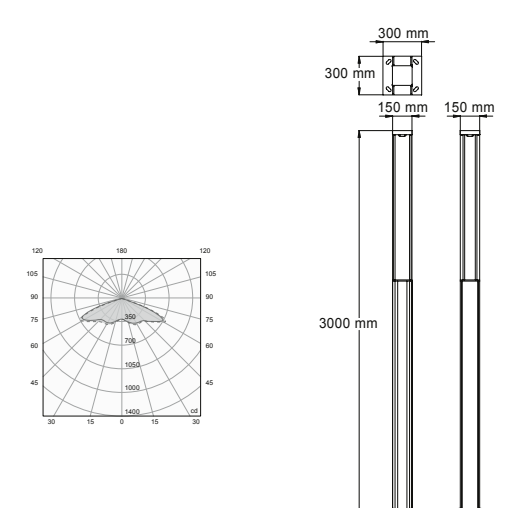
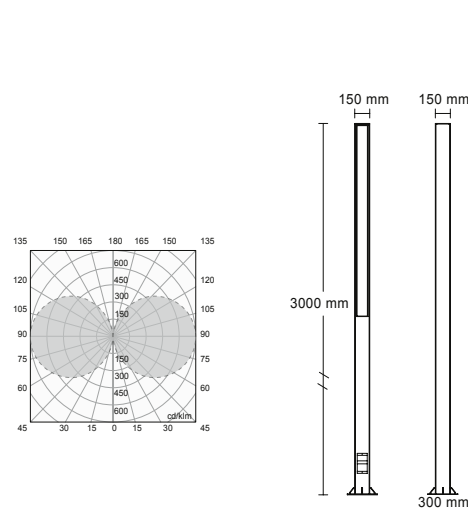
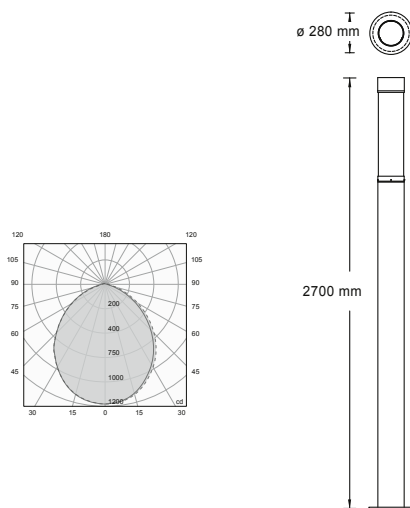
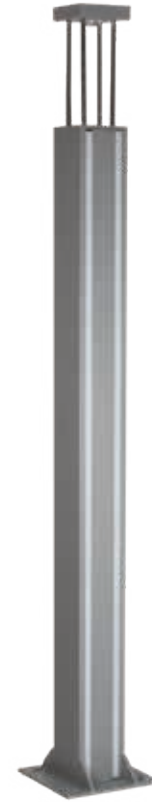

CÓDIGO	MATERIAL DE CUERPO	COLOR	POTENCIA	FLUJO LUMINOSO	ALIMENTACIÓN	TCC	VIDA ÚTIL (L80)	DRIVER	FUENTE DE LUZ	ÁNGULO DE APERTURA (VxH)	IRC	FP	IP	IK	PESO (KG)
OU9045FBNB	Aluminio	■	50 W	2360 lm	127-220 V	□ 4 000 K	30 000 h	Driver electrónico	LED Integrado	100°	77	0.9	65	4	9
OU9051GBNA	Aluminio	■	66 W	4800 lm	127-277 V	□ 4 000 K	25 000 h	Driver electrónico	LED Integrado	180°	80	0.95	65	4	8
OU9905GNCA	Aluminio	■	50 W	2600 lm	127-277 V	□ 4 000 K	50 000 h	Driver electrónico	LED Integrado	120°	70	0.9	65	4	10



MINI POSTE

OU9089SBCB

LED 12 WATTS 1000 LUMENS 3000K 360° ANGLULO APERTURA IP65 SATINADO

NUEVO

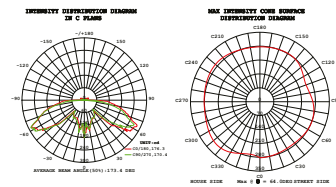
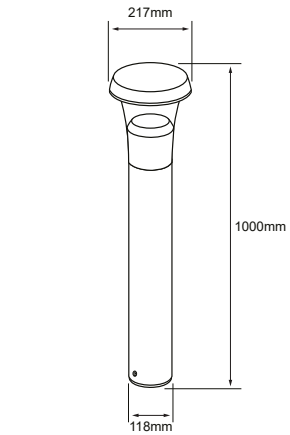

OU6046GBCB

LED 1x8.5 WATTS 350 LUMENS 3000K 360° ANGLULO APERTURA IP54 GRIS



BASE E26

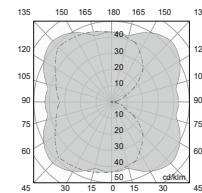
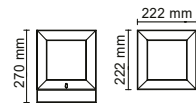

OU9050GBNB

LED 2x9 WATTS 1089 LUMENS 4000K 180° ANGLULO APERTURA IP65 GRIS



ILUMINACIÓN BILATERAL

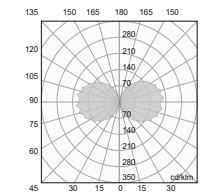
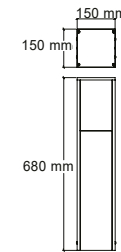

OU9047GBNB

LED 9 WATTS 220 LUMENS 4000K 65° ANGLULO APERTURA IP65 GRIS

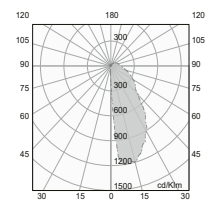
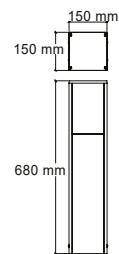

OU9092CBCA

LED 18 WATTS 2090 LUMENS 3000K 130° ANGLULO APERTURA IP65 CAFE OSCURO

NUEVO

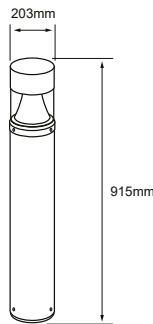

OU9093CBCA

LED 18 WATTS 1850 LUMENS 3000K 145° ANGLULO APERTURA IP65 CAFE

NUEVO

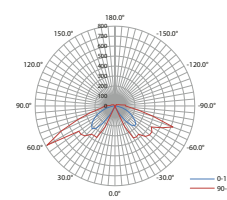
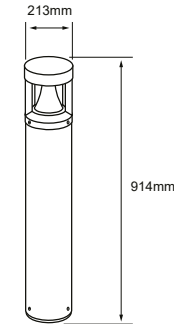

CÓDIGO	MATERIAL DE CUERPO	COLOR	POTENCIA	FLUJO LUMINOSO	ALIMENTACIÓN	TCC	VIDA ÚTIL (L80)	DRIVER	FUENTE DE LUZ	ÁNGULO DE APERTURA (VxH)	IRC	FP	IP	IK	PESO (KG)
OU9089SBCB	Aluminio	■	12 W	1000 lm	100-240 V ~	3 000 K	30 000 h	Driver LED	LED Integrado	360°	90	0.9	65	10	5
OU6046GBCB	Aluminio	■	1x8.5 W	350 lm	127-220 V	3 000 K	50 000 h	-	A19	360°	80	0.95	54	4	4.7
OU9050GBNB	Aluminio	■	2x9 W	1089 lm	127-220 V	4 000 K	25 000 h	Driver electrónico	LED Integrado	180°	70	0.95	65	5	4.3
OU9047GBNB	Aluminio	■	9 W	220 lm	127-220 V	4 000 K	25 000 h	Driver electrónico	LED Integrado	65°	80	0.85	65	5	4.3
OU9092CBCA	Aluminio	■	18 W	2090 lm	100-277 V ~	3 000 K	50 000 h	-	LED Integrado	130°	70	0.99	65	-	7
OU9093CBCA	Aluminio	■	18 W	1850 lm	100-277 V ~	3 000 K	50 000 h	-	LED Integrado	130°	70	0.99	65	-	7

OU9090FBNB

LED 10 WATTS 242 LUMENS 4000K 10x360° ANGULO APERTURA IP65 GRAFITO

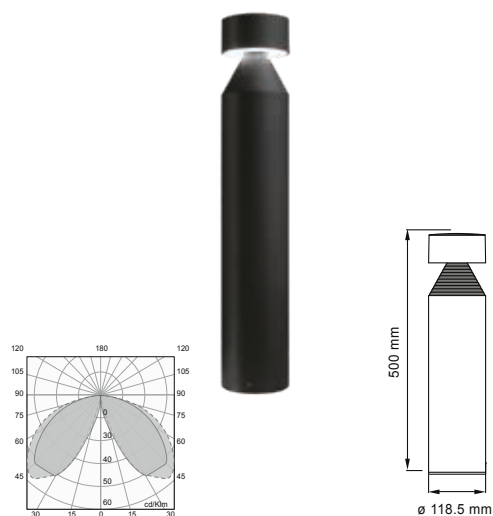

OU9004FBCB

LED 1x14 WATTS 96 LUMENS 3000K 180° ANGULO APERTURA IP65 GRAFITO

OU9004FBFB

LED 1x14 WATTS 96 LUMENS 6500K 180° ANGULO APERTURA IP65 GRAFITO

BASE E26



OU9091FBNB

LED 25 WATTS 780 LUMENS 4000K 120° ANGULO APERTURA IP65 GRAFITO



OU9095FBCB

LED 11 WATTS 625 LUMENS 2700K 60x180° ANGULO APERTURA IP54 GRAFITO

OU9095FBNB

LED 11 WATTS 625 LUMENS 4000K 60x180° ANGULO APERTURA IP54 GRAFITO



OU9085GBNB

LED 14 WATTS 1170 LUMENS 4000K 100/90° ANGULO APERTURA IP65 GRIS



CÓDIGO	MATERIAL DE CUERPO	COLOR	POTENCIA	FLUJO LUMINOSO	ALIMENTACIÓN	TCC	VIDA ÚTIL (L80)	DRIVER	FUENTE DE LUZ	ÁNGULO DE APERTURA (VxH)	IRC	FP	IP	IK	PESO (KG)
OU9090FBNB	Aluminio	■	10 W	242 lm	127-220 V	□ 4 000 K	50 000 h	Driver electrónico	LED Integrado	10x360°	80	0.45	65	4	2.39
OU9004FBCB	Aluminio	■	1x14 W	96 lm	127-220 V	■ 3 000 K	25 000 h	-	A19	180°	80	0.9	65	4	4
OU9004FBFB	Aluminio	■	1x14 W	96 lm	127-220 V	■ 6 500 K	25 000 h	-	A19	180°	80	0.9	65	4	4
OU9091FBNB	Aluminio	■	25 W	780 lm	127-220 V	□ 4 000 K	50 000 h	Driver electrónico	LED Integrado	120°	70	0.9	65	4	4.2
OU9095FBCB	Aluminio	■	11 W	625 lm	127-220 V	■ 2 700 K	50 000 h	Driver electrónico	LED Integrado	60x180°	80	0.9	54	5	4
OU9095FBNB	Aluminio	■	11 W	625 lm	127-220 V	□ 4 000 K	50 000 h	Driver electrónico	LED Integrado	60x180°	80	0.9	54	5	4
OU9085GBNB	Aluminio	■	14 W	1170 lm	127-220 V	□ 4 000 K	35 000 h	Driver electrónico	LED Integrado	100/90°	80	0.9	65	5	2.12



A photograph of a modern building at night. The building features a large glass facade that reflects the interior lights and the surrounding environment. The ground in front of the building is illuminated by several small, recessed floor lights, creating a warm glow. The sky is dark, and some trees are visible in the background, also illuminated by lights. The overall scene is a nighttime architectural showcase.

LUMINARIOS DE PISO

OU3595BCA

LED 50 WATTS 4000 LUMENS 3000K 10° ANGULO APERTURA IP67 SATINADO

OU3595SBFA

LED 50 WATTS 4000 LUMENS 5000K 10° ANGULO APERTURA IP67 SATINADO

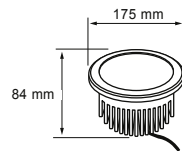
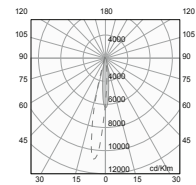

OU3596BCA

LED 50 WATTS 4000 LUMENS 3000K 30° ANGULO APERTURA IP67 SATINADO

OU3596SBFA

LED 50 WATTS 4000 LUMENS 5000K 30° ANGULO APERTURA IP67 SATINADO

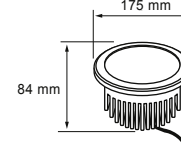
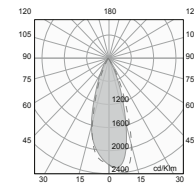

OU3597BCA

LED 50 WATTS 4000 LUMENS 3000K 10x40° ANGULO APERTURA IP67 SATINADO

OU3597SBFA

LED 50 WATTS 4000 LUMENS 5000K 10x40° ANGULO APERTURA IP67 SATINADO

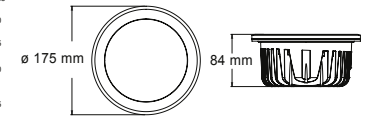
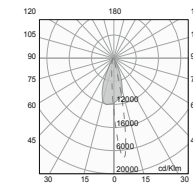

OU3608BCA

LED 50 WATTS 4095 LUMENS 3000K 35x25° ANGULO APERTURA IP67 SATINADO

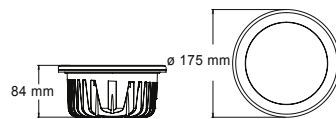
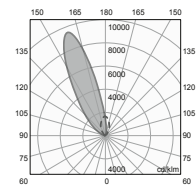

OU3032BCB

LED 7.5 WATTS 825 LUMENS 3000K 30° ANGULO APERTURA IP67 SATINADO

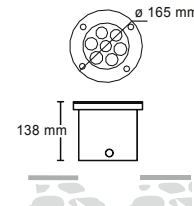
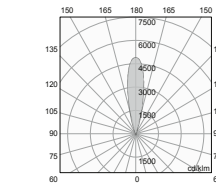

OU3034BCB

LED 4 WATTS 400 LUMENS 3000K 20° ANGULO APERTURA IP67 SATINADO

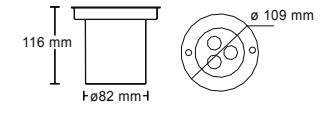
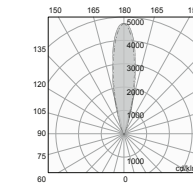

ACCESORIO PARA OU3032, OU3034
AC4013N
Conector de aislamiento IP 68



CÓDIGO	MATERIAL DE CUERPO	COLOR	POTENCIA	FLUJO LUMINOSO	ALIMENTACIÓN	TCC	VIDA ÚTIL (L80)	DRIVER	FUENTE DE LUZ	ÁNGULO DE APERTURA (VxH)	IRC	FP	IP	CORTE DE EMPOTRAMIENTO	IK	PESO (KG)
OU3595BCA	Aluminio	■	50 W	4000 lm	127-277 V	3 000 K	50 000 h	Driver electrónico	LED Integrado	10°	80	0.95	67	240X185 mm	9	2.8
OU3595SBFA	Aluminio	■	50 W	4000 lm	127-277 V	5 000 K	50 000 h	Driver electrónico	LED Integrado	10°	80	0.95	67	240X185 mm	9	2.8
OU3596BCA	Aluminio	■	50 W	4 000 lm	127-277 V	3 000 K	50 000 h	Driver electrónico	LED Integrado	30°	80	0.95	67	240X185 mm	9	2.8
OU3596SBFA	Aluminio	■	50 W	4 000 lm	127-277 V	5 000 K	50 000 h	Driver electrónico	LED Integrado	30°	80	0.95	67	240X185 mm	9	2.8
OU3597BCA	Aluminio	■	50 W	4000 lm	127-277 V	3 000 K	50 000 h	Driver electrónico	LED Integrado	10x40°	80	0.95	67	240X185 mm	9	2.8
OU3597SBFA	Aluminio	■	50 W	4000 lm	127-277 V	5 000 K	50 000 h	Driver electrónico	LED Integrado	10x40°	80	0.95	67	240X185 mm	9	2.8
OU3608BCA	Aluminio	■	50 W	4095 lm	127-277 V	3 000 K	50 000 h	Driver electrónico	LED Integrado	35x25°	80	0.95	67	240X185 mm	9	2.8
OU3032BCB	Aluminio	■	7.5 W	825 lm	127-220 V	3 000 K	50 000 h	Driver electrónico	LED Integrado	30°	80	0.9	67	165X138 mm	9	1.3
OU3034BCB	Aluminio	■	4 W	400 lm	127-220 V	3 000 K	25 000 h	Driver electrónico	LED Integrado	20°	70	0.95	67	109X114 mm	9	0.566

OU3580NBCD

LED 10 WATTS 880 LUMENS 3000K 80° ANGLULO APERTURA IP67 NEGRO

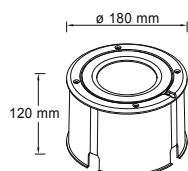
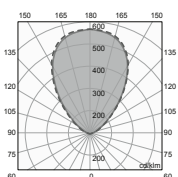

DIRIGIBLE

**OU3581NBCB**

LED 23 WATTS 1015 LUMENS 3000K 24° ANGLULO APERTURA IP67 NEGRO

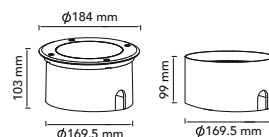
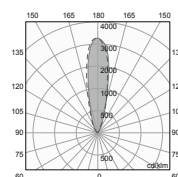

DIRIGIBLE

**OU3591NBCA**

LED 14 WATTS 1240 LUMENS 3000K 35x25° ANGLULO APERTURA IP67 NEGRO



DIRIGIBLE

OU3591NBFA

LED 14 WATTS 1240 LUMENS 5000K 35x25° ANGLULO APERTURA IP67 NEGRO

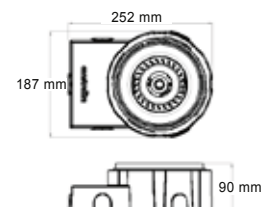
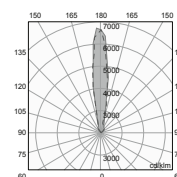

DIRIGIBLE

**OU3592NBCA**

LED 14 WATTS 1240 LUMENS 3000K 50° ANGLULO APERTURA IP67 NEGRO

OU3592NBFA

LED 14 WATTS 1240 LUMENS 5000K 50° ANGLULO APERTURA IP67 NEGRO

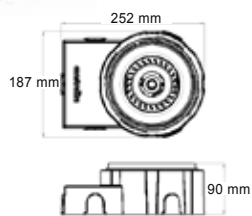
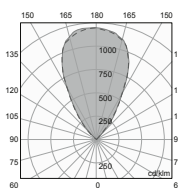

IDEAL ZONA COCINA

**OU3593NBCA**

LED 14 WATTS 1240 LUMENS 3000K 30° ANGLULO APERTURA IP67 NEGRO

OU3593NBFA

LED 14 WATTS 1240 LUMENS 5000K 30° ANGLULO APERTURA IP67 NEGRO

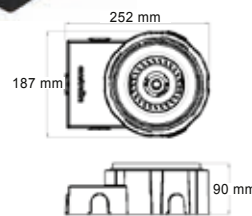
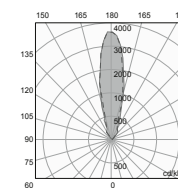

IDEAL ZONA COCINA

**OU3594NBCA**

LED 14 WATTS 1240 LUMENS 3000K 15° ANGLULO APERTURA IP67 NEGRO

OU3594NBFA

LED 14 WATTS 1240 LUMENS 5000K 15° ANGLULO APERTURA IP67 NEGRO



IDEAL ZONA COCINA

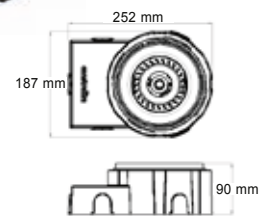
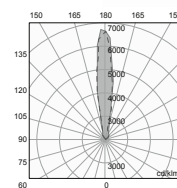

ACCESORIO PARA OU3591, OU3592, OU3593, OU3594

AC3471N

HOUSING para entre pisos. (INCLUIDO)

CÓDIGO	MATERIAL DE CUERPO	COLOR	POTENCIA	FLUJO LUMINOSO	ALIMENTACIÓN	TCC	VIDA ÚTIL (L80)	DRIVER	FUENTE DE LUZ	ÁNGULO DE APERTURA (VxH)	IRC	FP	IP	CORTE DE EMPOTRAMIENTO	IK	PESO (KG)
OU3580NBCD	ABS	■	20 W	880 lm	127 V	3 000 K	30 000 h	Driver electrónico	LED Integrado	80°	80	0.7	67	170X103 mm	9	1
OU3581NBCB	Aluminio	■	23 W	1015 lm	127-220 V	3 000 K	30 000 h	Driver electrónico	LED Integrado	24°	80	0.9	67	170X103 mm	9	2.2
OU3591NBCA	ABS	■	14 W	1240 lm	127-277 V	3 000 K	35 000 h	Driver electrónico	LED Integrado	35x25°	80	0.9	67	255X90 mm	9	1.5
OU3591NBFA	ABS	■	14 W	1240 lm	127-277 V	5 000 K	35 000 h	Driver electrónico	LED Integrado	35x25°	80	0.9	67	255X90 mm	9	1.5
OU3592NBCA	ABS	■	14 W	1240 lm	127-277 V	3 000 K	35 000 h	Driver electrónico	LED Integrado	50°	80	0.9	67	255X90 mm	9	1.5
OU3592NBFA	ABS	■	14 W	1240 lm	127-277 V	5 000 K	35 000 h	Driver electrónico	LED Integrado	50°	80	0.9	67	255X90 mm	9	1.5
OU3593NBCA	ABS	■	14 W	1240 lm	127-277 V	3 000 K	35 000 h	Driver electrónico	LED Integrado	30°	80	0.9	67	255X90 mm	9	1.5
OU3593NBFA	ABS	■	14 W	1240 lm	127-277 V	5 000 K	35 000 h	Driver electrónico	LED Integrado	30°	80	0.9	67	255X90 mm	9	1.5
OU3594NBCA	ABS	■	14 W	1240 lm	127-277 V	3 000 K	35 000 h	Driver electrónico	LED Integrado	15°	80	0.9	67	255X90 mm	9	1.5
OU3594NBFA	ABS	■	14 W	1240 lm	127-277 V	5 000 K	35 000 h	Driver electrónico	LED Integrado	15°	80	0.9	67	255X90 mm	9	1.5

OU3174NBCA

LED 19 WATTS 2100 LUMENS 3000K 9° ANGULO APERTURA IP67 NEGRO

NUEVO

OU3174NBFA

LED 19 WATTS 2300 LUMENS 5000K 9° ANGULO APERTURA IP67 NEGRO

OU3168NBCA

LED 11 WATTS 1180 LUMENS 3000K 9° ANGULO APERTURA IP67 NEGRO

OU3168NBFA

LED 11 WATTS 1300 LUMENS 5000K 9° ANGULO APERTURA IP67 NEGRO

OU3150NBCB

LED 8 WATTS 720 LUMENS 3000K 9° ANGULO APERTURA IP67 NEGRO

OU3150NBFB

LED 8 WATTS 800 LUMENS 5000K 9° ANGULO APERTURA IP67 NEGRO

OU3176NAMA

LED 19 WATTS 1250 LUMENS AMBAR 23° ANGULO APERTURA IP67 NEGRO

NUEVO

OU3176NBCA

LED 19 WATTS 2100 LUMENS 3000K 23° ANGULO APERTURA IP67 NEGRO

OU3176NBFA

LED 19 WATTS 2300 LUMENS 5000K 23° ANGULO APERTURA IP67 NEGRO

OU3170NBCA

LED 11 WATTS 1180 LUMENS 3000K 23° ANGULO APERTURA IP67 NEGRO

OU3170NBFA

LED 11 WATTS 1300 LUMENS 5000K 23° ANGULO APERTURA IP67 NEGRO

OU3152NBCB

LED 8 WATTS 720 LUMENS 3000K 23° ANGULO APERTURA IP67 NEGRO

OU3152NBFB

LED 8 WATTS 800 LUMENS 5000K 23° ANGULO APERTURA IP67 NEGRO

OU3178NAMA

LED 19 WATTS 1250 LUMENS AMBAR 10x40° ANGULO APERTURA IP67 NEGRO

NUEVO

OU3178NBCA

LED 19 WATTS 2100 LUMENS 3000K 10x40° ANGULO APERTURA IP67 NEGRO

OU3178NBFA

LED 19 WATTS 2300 LUMENS 5000K 10x40° ANGULO APERTURA IP67 NEGRO

OU3172NBFA

LED 11 WATTS 1300 LUMENS 5000K 10x40° ANGULO APERTURA IP67 NEGRO

OU3154NBCB

LED 8 WATTS 720 LUMENS 3000K 10x40° ANGULO APERTURA IP67 NEGRO

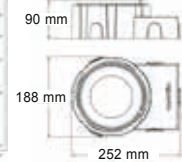
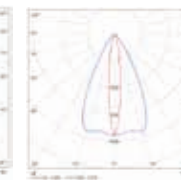
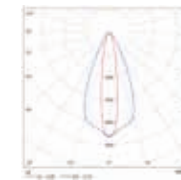
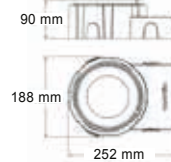
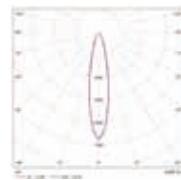
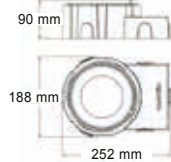
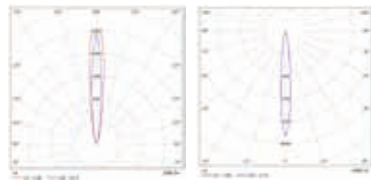

CÓDIGO	MATERIAL DE CUERPO	COLOR	POTENCIA	FLUJO LUMINOSO	ALIMENTACIÓN	TCC	VIDA ÚTIL (L80)	DRIVER	FUENTE DE LUZ	ÁNGULO DE APERTURA (VxH)	IRC	FP	IP	CORTE DE EMPOTRAMIENTO	IK	PESO (KG)
OU3174NBCA	Aluminio	■	19 W	2100 lm	127-277 V	3 000 K	50 000 h	Driver electrónico	LED Integrado	9°	70	0.95	67	255X90 mm	9	0.5
OU3174NBFA	Aluminio	■	19 W	2300 lm	127-277 V	5 000 K	50 000 h	Driver electrónico	LED Integrado	9°	70	0.95	67	255X90 mm	9	0.5
OU3168NBCA	ABS	■	11 W	1180 lm	127-277 V	3 000 K	50 000 h	Driver electrónico	LED Integrado	9°	70	0.95	67	255X90 mm	9	0.5
OU3168NBFA	ABS	■	11 W	1300 lm	127-277 V	5 000 K	50 000 h	Driver electrónico	LED Integrado	9°	70	0.95	67	255X90 mm	9	0.5
OU3150NBCB	Aluminio	■	8 W	720 lm	127-220 V	3 000 K	50 000 h	Driver electrónico	LED Integrado	9°	70	0.9	67	255X90 mm	9	0.5
OU3150NBFB	Aluminio	■	8 W	800 lm	127-220 V	5 000 K	50 000 h	Driver electrónico	LED Integrado	9°	70	0.9	67	255X90 mm	9	0.5
OU3176NAMA	ABS	■	19 W	1250 lm	127-277 V	Ambar	50 000 h	Driver electrónico	LED Integrado	23°	70	0.95	67	255x200 mm	9	0.5
OU3176NBCA	Aluminio	■	19 W	2100 lm	127-277 V	3 000 K	50 000 h	Driver electrónico	LED Integrado	23°	70	0.95	67	255X90 mm	9	0.5
OU3176NBFA	Aluminio	■	19 W	2300 lm	127-277 V	5 000 K	50 000 h	Driver electrónico	LED Integrado	23°	70	0.95	67	255X90 mm	9	0.5
OU3170NBCA	ABS	■	11 W	1180 lm	127-277 V	3 000 K	50 000 h	Driver electrónico	LED Integrado	23°	70	0.95	67	255X90 mm	9	0.5
OU3170NBFA	ABS	■	11 W	1300 lm	127-277 V	5 000 K	50 000 h	Driver electrónico	LED Integrado	23°	70	0.95	67	255X90 mm	9	0.5
OU3152NBCB	ABS	■	8 W	720 lm	127-220 V	3 000 K	50 000 h	Driver electrónico	LED Integrado	23°	70	0.9	67	255X90 mm	9	0.5
OU3152NBFB	ABS	■	8 W	800 lm	127-220 V	5 000 K	50 000 h	Driver electrónico	LED Integrado	23°	70	0.9	67	255X90 mm	9	0.5
OU3178NAMA	ABS	■	19 W	1250 lm	127-277 V	Ambar	50 000 h	Driver electrónico	LED Integrado	10x40°	70	0.95	67	255x200 mm	9	0.5
OU3178NBCA	ABS	■	19 W	2100 lm	127-277 V	3 000 K	50 000 h	Driver electrónico	LED Integrado	10x40°	70	0.95	67	255X90 mm	9	0.5
OU3178NBFA	ABS	■	19 W	2300 lm	127-277 V	5 000 K	50 000 h	Driver electrónico	LED Integrado	10x40°	70	0.95	67	255X90 mm	9	0.5
OU3172NBFA	ABS	■	11 W	1300 lm	127-277 V	5 000 K	50 000 h	Driver electrónico	LED Integrado	10x40°	70	0.95	67	255X90 mm	9	0.5
OU3154NBCB	ABS	■	8 W	720 lm	127-220 V	3 000 K	50 000 h	Driver electrónico	LED Integrado	10x40°	70	0.9	67	255X90 mm	9	0.5

OU3163NBCA

LED 20 WATTS 1530 LUMENS 3000K 24° ANGLULO APERTURA IP67 NEGRO

NUEVO

*Ópticas dirigibles
*Incluye Housing

DIRIGIBLE

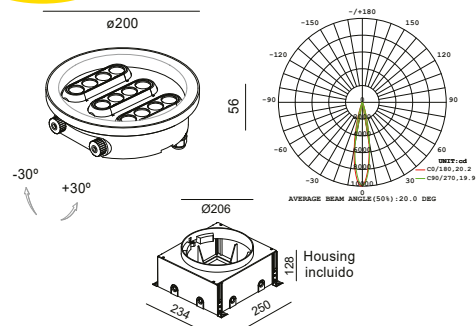

OU3166NBCA

LED 19.5 WATTS 1483 LUMENS 3000K 24° ANGLULO APERTURA IP67 NEGRO

NUEVO

*Ópticas dirigibles
*Incluye Housing

DIRIGIBLE

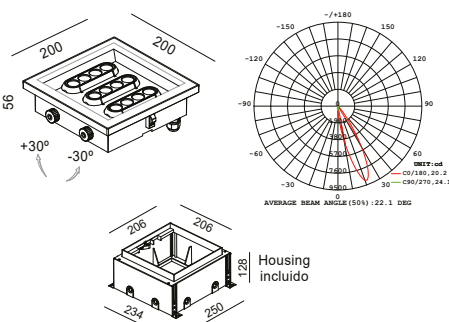

OU3162NBCA

LED 13.5 WATTS 932 LUMENS 3000K 24° ANGLULO APERTURA IP67 NEGRO

NUEVO

*Ópticas dirigibles
*Incluye Housing

DIRIGIBLE

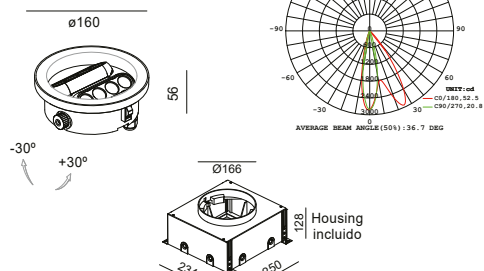

OU3165NBCA

LED 13.5 WATTS 932 LUMENS 3000K 24° ANGLULO APERTURA IP67 NEGRO

NUEVO

*Ópticas dirigibles
*Incluye Housing

DIRIGIBLE

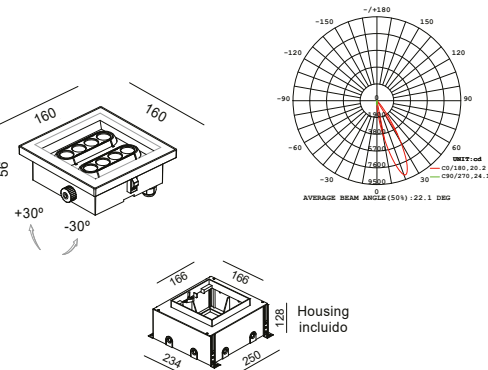

OU3161NBCA

LED 10 WATTS 603 LUMENS 3000K 24° ANGLULO APERTURA IP67 NEGRO

NUEVO

*Ópticas dirigibles
*Incluye Housing

DIRIGIBLE

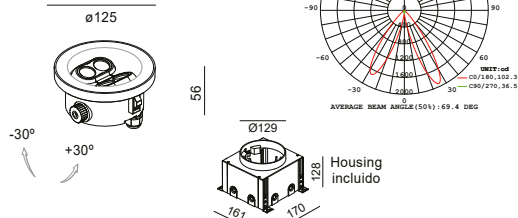

OU3164NBCA

LED 5.5 WATTS 296 LUMENS 3000K 24° ANGLULO APERTURA IP67 NEGRO

NUEVO

*Ópticas dirigibles
*Incluye Housing

DIRIGIBLE

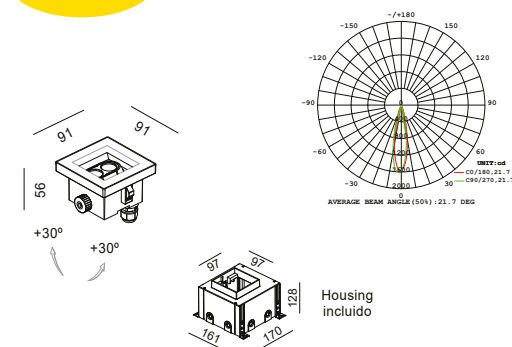

OU3160NBCA

LED 6 WATTS 310 LUMENS 3000K 24° ANGLULO APERTURA IP67 NEGRO

NUEVO

*Ópticas dirigibles
*Incluye Housing

DIRIGIBLE

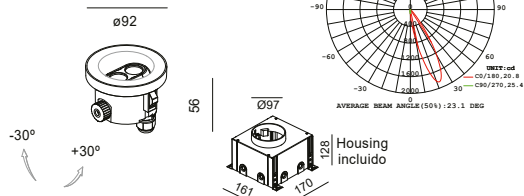

CÓDIGO	MATERIAL DE CUERPO	COLOR	POTENCIA	FLUJO LUMINOSO	ALIMENTACIÓN	TCC	VIDA ÚTIL (L80)	DRIVER	FUENTE DE LUZ	ÁNGULO DE APERTURA (VxH)	IRC	FP	IP	CORTE DE EMPOTRAMIENTO	IK	PESO (KG)
OU3163NBCA	Aluminio/PC	■	20 W	1530 lm	100-277 V ~	3 000 K	30000 h	Driver Electrónico	LED Integrado	24°	80	0.9	67	202 mm	10	3.04
OU3166NBCA	Aluminio/PC	■	19.5 W	1483 lm	100-277 V ~	3 000 K	30000 h	Driver Electrónico	LED Integrado	24°	80	0.9	67	208 mm	10	2.6
OU3162NBCA	Aluminio/PC	■	13.5 W	932 lm	100-277 V ~	3 000 K	30000 h	Driver Electrónico	LED Integrado	24°	80	0.9	67	167 mm	10	1.75
OU3165NBCA	Aluminio/PC	■	13.5 W	932 lm	100-277 V ~	3 000 K	30000 h	Driver Electrónico	LED Integrado	24°	80	0.9	67	167 mm	10	1.85
OU3161NBCA	Aluminio/PC	■	10 W	603 lm	100-277 V ~	3 000 K	30000 h	Driver Electrónico	LED Integrado	24°	80	0.9	67	134 mm	10	1.14
OU3160NBCA	Aluminio/PC	■	6 W	310 lm	100-277 V ~	3 000 K	30000 h	Driver Electrónico	LED Integrado	24°	80	0.9	67	100 mm	10	0.68
OU3164NBCA	Aluminio/PC	■	5.5 W	296 lm	100-277 V ~	3 000 K	30000 h	Driver Electrónico	LED Integrado	24°	80	0.9	67	99 mm	10	0.67

*Luminarios sin marco para mimetizar su presencia al empotrarse en piso.

*Sistema independiente con fuentes de luz dirigibles.

OU3044NBFB

LED 4 WATTS 350 LUMENS 5000K 9° ANGLULO APERTURA IP67 NEGRO

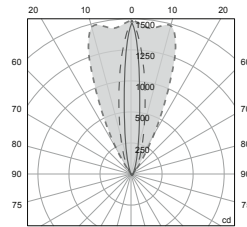
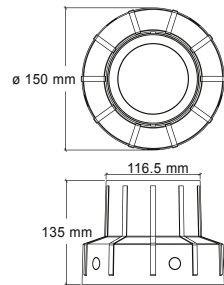

OU3048NBCB

LED 4 WATTS 350 LUMENS 3000K 10x40° ANGLULO APERTURA IP67 NEGRO

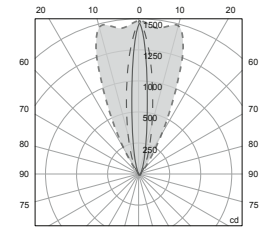
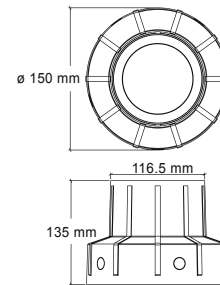

OU3050NBFB

LED 7 WATTS 500 LUMENS 5000K 9° ANGLULO APERTURA IP67 NEGRO

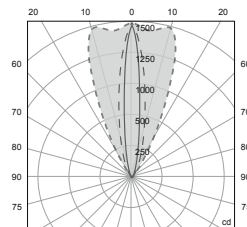
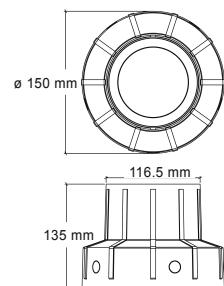

OU3074NAMA

LED 21 WATTS 1730 LUMENS AMBAR 9° ANGLULO APERTURA IP67 NEGRO

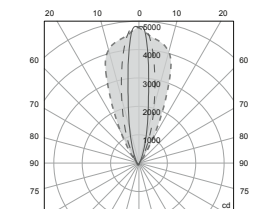
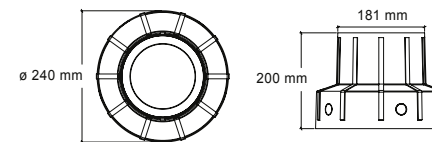

ACCESORIO PARA OU3074

AC3471N

Housing para entre pisos.

CÓDIGO	MATERIAL DE CUERPO	COLOR	POTENCIA	FLUJO LUMINOSO	ALIMENTACIÓN	TCC	VIDA ÚTIL (L80)	DRIVER	FUENTE DE LUZ	ÁNGULO DE APERTURA (vxH)	IRC	FP	IP	CORTE DE EMPOTRAMIENTO	IK	PESO (KG)
OU3044NBFB	Aluminio	■	4 W	350 lm	127-220 V	5 000 K	25 000 h	Driver electrónico	LED Integrado	9°	70	0.9	67	153X135 mm	9	1
OU3048NBCB	Aluminio	■	4 W	350 lm	127-220 V	3 000 K	25 000 h	Driver electrónico	LED Integrado	10x40°	70	0.9	67	153X135 mm	9	1
OU3050NBFB	Aluminio	■	7 W	500 lm	127-220 V	5 000 K	25 000 h	Driver electrónico	LED Integrado	9°	70	0.9	67	153X135 mm	9	1
OU3074NAMA	Aluminio	■	21 W	1730 lm	127-277 V	Ambar	25 000 h	Driver electrónico	LED Integrado	9°	70	0.9	67	240x200 mm	9	1

OU3051NBFB

LED 7 WATTS 500 LUMENS 5000K 9° ANGULO APERTURA IP67 NEGRO

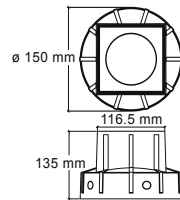
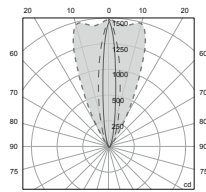

OU3057NBFA

LED 11 WATTS 900 LUMENS 5000K 9° ANGULO APERTURA IP67 NEGRO

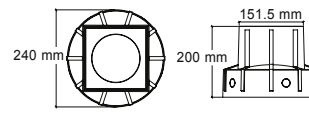
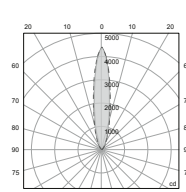

OU3059NBFA

LED 11 WATTS 900 LUMENS 5000K 23° ANGULO APERTURA IP67 NEGRO

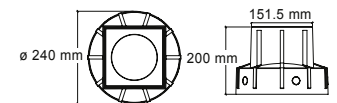
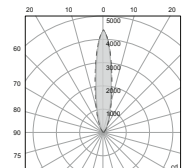

OU3075NAMA

LED 21 WATTS 1730 LUMENS AMBAR 9° ANGULO APERTURA IP67 NEGRO

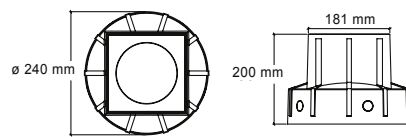
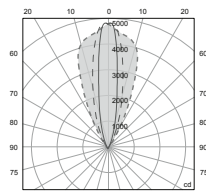

OU3077NBFA

LED 21 WATTS 1730 LUMENS 5000K 23° ANGULO APERTURA IP67 NEGRO

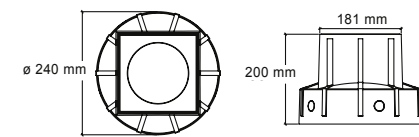
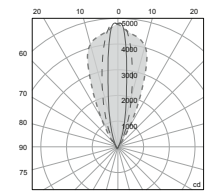

ACCESORIO PARA OU3057, OU3059, OU3075, OU3077

AC3471N

Housing para entre pisos.

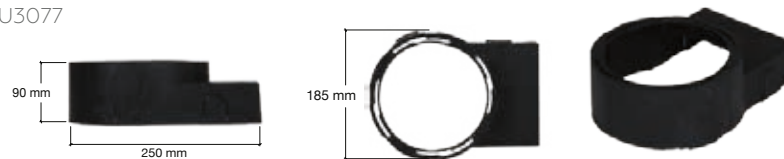

CÓDIGO	MATERIAL DE CUERPO	COLOR	POTENCIA	FLUJO LUMINOSO	ALIMENTACIÓN	TCC	VIDA ÚTIL (L80)	DRIVER	FUENTE DE LUZ	ÁNGULO DE APERTURA (VxH)	IRC	FP	IP	CORTE DE EMPOTRAMIENTO	IK	PESO (KG)
OU3051NBFB	Aluminio	■	7 W	500 lm	127-220 V	5 000 K	25 000 h	Driver electrónico	LED Integrado	9°	70	0.9	67	153X135 mm	9	1
OU3057NBFA	Aluminio	■	11 W	900 lm	127-277 V	5 000 K	25 000 h	Driver electrónico	LED Integrado	9°	70	0.9	67	240X200 mm	9	1
OU3059NBFA	Aluminio	■	11 W	900 lm	127-277 V	3 000 K	25 000 h	Driver electrónico	LED Integrado	23°	70	0.9	67	240X200 mm	9	1
OU3059NBFA	Aluminio	■	11 W	900 lm	127-277 V	5 000 K	25 000 h	Driver electrónico	LED Integrado	23°	70	0.9	67	240X200 mm	9	1
OU3075NAMA	Aluminio	■	21 W	1730 lm	127-277 V	Ambar	25 000 h	Driver electrónico	LED Integrado	9°	70	0.9	67	240x200 mm	9	1
OU3077NBFA	Aluminio	■	21 W	1730 lm	127-277 V	5 000 K	25 000 h	Driver electrónico	LED Integrado	23°	70	0.9	67	240x200 mm	9	1

OU3026AB

LED 0.6 WATTS 15 LUMENS AMBAR 180° ANGULO APERTURA IP67 SATINADO

OU3026BCB

LED 0.6 WATTS 15 LUMENS 3000K 180° ANGULO APERTURA IP67 SATINADO

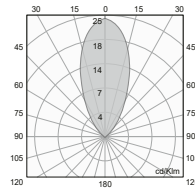

RE2006SBCB

LED 6 WATTS 142 LUMENS 3000K 140° ANGULO APERTURA IP67 SATINADO

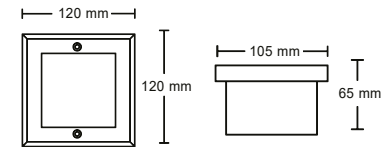
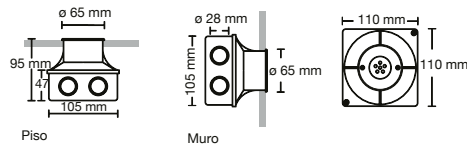
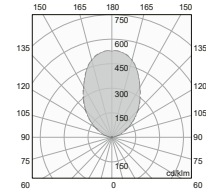
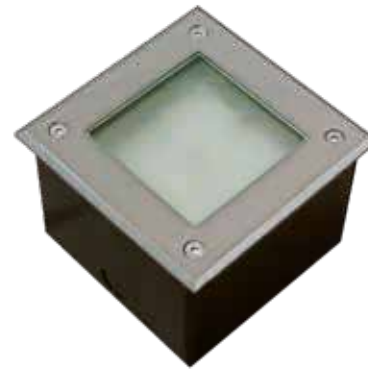

OU3027GBCF

LED 1 WATTS 60 LUMENS 3000K 180° ANGULO APERTURA IP65 GRIS

NUEVO



-Incluye Housing.

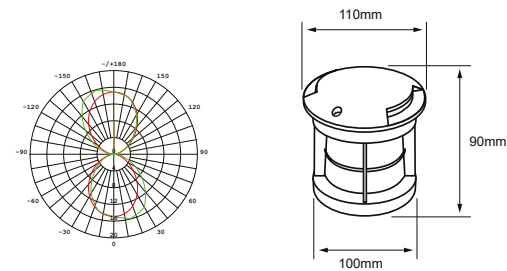

OU3028GBCF

LED 0.5 WATTS 30 LUMENS 3000K 90° ANGULO APERTURA IP65 GRIS

NUEVO



-Incluye Housing.

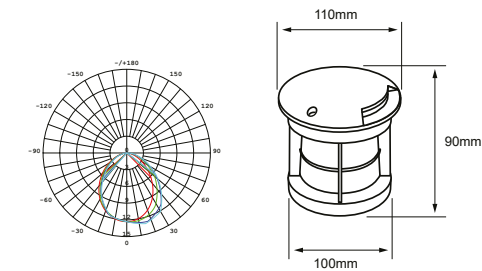

OU3029GBCF

LED 3 WATTS 60 LUMENS 3000K 180° ANGULO APERTURA IP65 GRIS

NUEVO



-Incluye Housing.

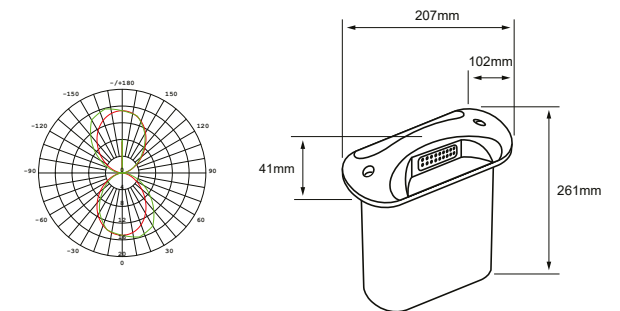

CÓDIGO	MATERIAL DE CUERPO	COLOR	POTENCIA	FLUJO LUMINOSO	ALIMENTACIÓN	TCC	VIDA ÚTIL (L80)	DRIVER	FUENTE DE LUZ	ÁNGULO DE APERTURA (vxH)	IRC	FP	IP	CORTE DE EMPOTRAMIENTO	IK	PESO (KG)
OU3026AB	Aluminio	■	0.6 W	15 lm	127-220 V	■ Ambar	25 000 h	Driver electrónico	LED Integrado	180°	80	0.5	67	110x95 mm	9	0.452
OU3026BCB	Aluminio	■	0.6 W	15 lm	127-220 V	■ 3 000 K	25 000 h	Driver electrónico	LED Integrado	180°	80	0.5	67	110x110 mm	9	0.452
RE2006SBCB	Aluminio	■	6 W	142 lm	127-220 V	■ 3 000 K	25 000 h	Driver electrónico	LED Integrado	140°	80	0.7	67	105x65 mm	9	1.6
OU3027GBCF	Aluminio	■	1 W	60 lm	24 VCD	■ 3 000 K	30000 h	Driver LED	LED Integrado	180°	90	0.9	65	120 mm	10	0.5
OU3028GBCF	Aluminio	■	0.5 W	30 lm	24 VCD	■ 3 000 K	30000 h	Driver LED	LED Integrado	90°	90	0.9	65	120 mm	10	0.5
OU3029GBCF	Aluminio	■	3 W	60 lm	24 VCD	■ 3 000 K	30000 h	Driver LED	LED Integrado	180°	90	0.9	65	170 x 90 mm	10	1

OU3705BCA

LED 21 WATTS 2268 LUMENS 3000K 20° ANGULO APERTURA IP67 SATINADO

NUEVO

*Óptica dirigible
*Incluye Housing

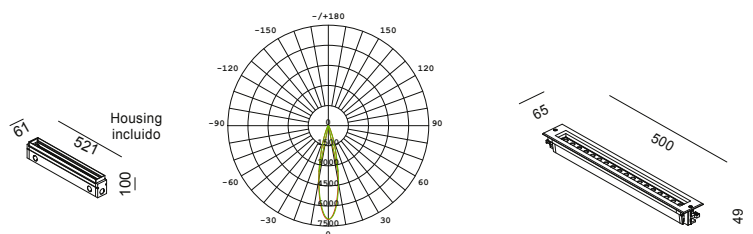

OU3095BCA

LED 6 WATTS 409 LUMENS 3000K 50° ANGULO APERTURA IP67 SATINADO

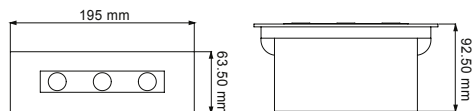
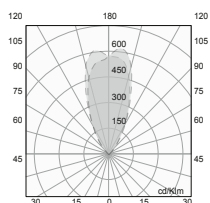

OU3096BCA

LED 12 WATTS 871 LUMENS 3000K 50° ANGULO APERTURA IP67 SATINADO

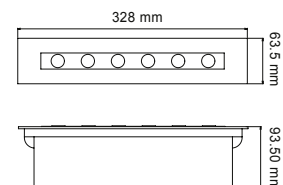
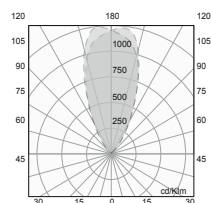

CÓDIGO	MATERIAL DE CUERPO	COLOR	POTENCIA	FLUJO LUMINOSO	ALIMENTACIÓN	TCC	VIDA ÚTIL (L80)	DRIVER	FUENTE DE LUZ	ÁNGULO DE APERTURA (VxH)	IRC	FP	IP	CORTE DE EMPOTRAMIENTO	IK	PESO (KG)
OU3705BCA	Aluminio	■	21 W	2268 lm	100-240 V ~	3 000 K	50000 h	Driver LED	LED Integrado	20°	80	0.85	67	-	9	0.82
OU3095BCA	Aluminio	■	6 W	409 lm	127-277 V	3 000 K	25 000 h	Driver electrónico	LED Integrado	50°	80	0.7	67	195x63X90 mm	9	0.9
OU3096BCA	Aluminio	■	12 W	871 lm	127-277 V	3 000 K	25 000 h	Driver electrónico	LED Integrado	50°	80	0.7	67	328x63X90 mm	9	1.5



BOYA



OU3141FBFA

LED 3 WATTS 84 LUMENS 5000K 10x40° ANGLULO APERTURA IP65 GRAFITO

NUEVO**OU3141GBFA**

LED 3 WATTS 84 LUMENS 5000K 10x40° ANGLULO APERTURA IP65 GRIS

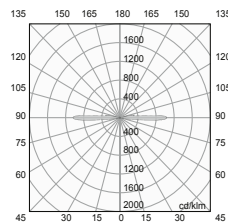
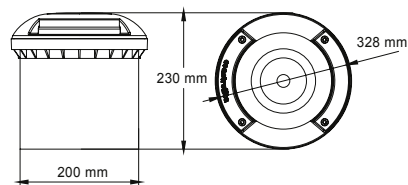
**OU3042FBFA**

LED 3 WATTS 84 LUMENS 5000K 10x40° ANGLULO APERTURA IP65 GRAFITO

NUEVO**OU3042GBFA**

LED 3 WATTS 84 LUMENS 5000K 10x40° ANGLULO APERTURA IP65 GRIS

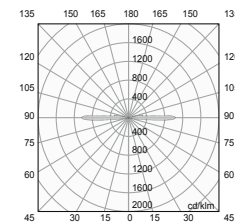
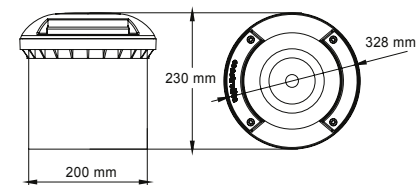

CÓDIGO	MATERIAL DE CUERPO	COLOR	POTENCIA	FLUJO LUMINOSO	ALIMENTACIÓN	TCC	VIDA ÚTIL (L80)	DRIVER	FUENTE DE LUZ	ÁNGULO DE APERTURA (vxH)	IRC	FP	IP	CORTE DE EMPOTRAMIENTO	IK	PESO (KG)
OU3141FBFA	Aluminio	■	3 W	84 lm	127-277 V	■ 5 000 K	25 000 h	Driver electrónico	LED Integrado	10x40°	70	0.9	65	200X230 mm	9	5
OU3141GBFA	Aluminio	■	3 W	84 lm	127-277 V	■ 5 000 K	25 000 h	Driver electrónico	LED Integrado	10x40°	70	0.9	65	200X230 mm	9	5
OU3042FBFA	Aluminio	■	3 W	84 lm	127-277 V	■ 5 000 K	50 000 h	Driver electrónico	LED Integrado	10x40°	70	0.9	65	200X230 mm	9	5
OU3042GBFA	Aluminio	■	3 W	84 lm	127-277 V	■ 5 000 K	50 000 h	Driver electrónico	LED Integrado	10x40°	70	0.9	65	200X230 mm	9	5



SUMERGIBLE

OU7046SBCG



OU7046SRGG



OU7048SBCG

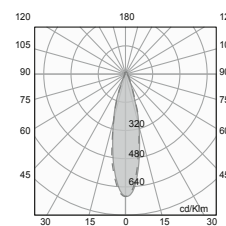
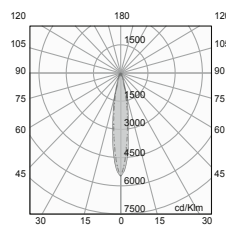
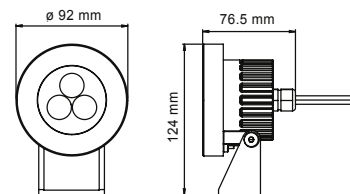
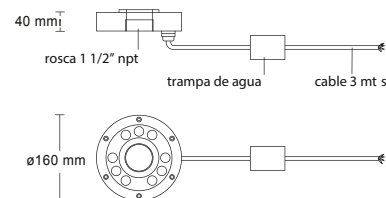

ACCESORIO

AC1044G

Driver electrónico de 350 W con voltaje de alimentación de 127V.

ACCESORIO

AC7018B

Driver electrónico de 18W



CÓDIGO	MATERIAL DE CUERPO	COLOR	POTENCIA	FLUJO LUMINOSO	ALIMENTACIÓN	TCC	VIDA ÚTIL (L80)	DRIVER	FUENTE DE LUZ	ÁNGULO DE APERTURA (VxH)	IRC	FP	IP	IK	PESO (KG)
OU7046SBCG	Acero	■	33 W	400 lm	24 V	■ 3 000 K	25 000 h	No incluye Driver	LED Integrado	18°	70	-	68	7	2.7
OU7046SRGG	Acero	■	33 W	400 lm	24 V	■ RGB	25 000 h	No incluye Driver	LED Integrado	18°	70	-	68	7	2.7
OU7048SBCG	Acero	■	6 W	160 lm	12 V	■ 3 000 K	30 000 h	No incluye Driver	LED Integrado	24°	80	0.5	68	7	0.5

ILUMINACIÓN DE JARDÍN

A nighttime photograph of a modern building courtyard. The scene is dominated by several tall palm trees with textured trunks, which are illuminated from below, creating a warm glow. The ground is a polished, reflective surface that mirrors the lights and the building. In the background, a multi-story building with large glass windows is visible, some of which are lit from within. The overall atmosphere is sophisticated and contemporary.

OU7023NBCG

LED 2 WATTS 140 LUMENS 3000K 15° ANGLULO APERTURA IP65 NEGRO

ESTACA DESMONTABLE

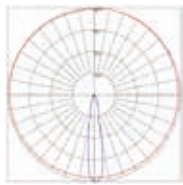
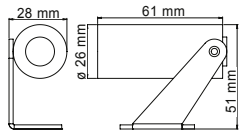

OU7020NBCA

LED 9 WATTS 490 LUMENS 3000K 30° ANGLULO APERTURA IP65 NEGRO

ESTACA DESMONTABLE

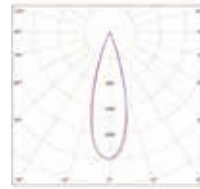
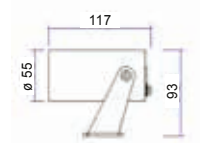

OU7021NBCA

LED 14 WATTS 1200 LUMENS 3000K 45° ANGLULO APERTURA IP65 NEGRO

ESTACA DESMONTABLE

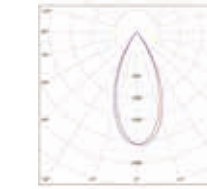
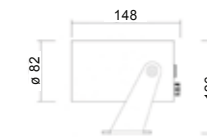

OU7022NBCB

LED 27 WATTS 2720 LUMENS 3000K 20° ANGLULO APERTURA IP65 NEGRO

ESTACA DESMONTABLE

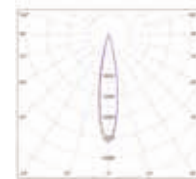
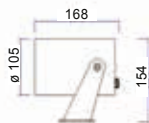

OU7027NBCA

LED 4.3 WATTS 196 LUMENS 3000K 18° ANGLULO APERTURA IP65 NEGRO

NUEVO

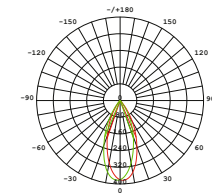
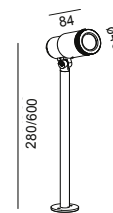

CÓDIGO	MATERIAL DE CUERPO	COLOR	POTENCIA	FLUJO LUMINOSO	ALIMENTACIÓN	TCC	VIDA ÚTIL (L80)	DRIVER	FUENTE DE LUZ	ÁNGULO DE APERTURA (VxH)	IRC	FP	IP	IK	PESO (KG)
OU7023NBCG	Aluminio	■	2 W	140 lm	24 V	3 000 K	25 000 h	No incluye Driver	LED Integrado	15°	80	0.7	65	4	0.2
OU7020NBCA	Aluminio	■	9 W	490 lm	127-277 V	3 000 K	25 000 h	Driver electrónico	LED Integrado	30°	80	0.8	65	4	0.21
OU7021NBCA	Aluminio	■	14 W	1200 lm	127-277 V	3 000 K	25 000 h	Driver electrónico	LED Integrado	45°	80	0.8	65	4	0.23
OU7022NBCB	Aluminio	■	27 W	2720 lm	127-220 V	3 000 K	30 000 h	Driver electrónico	LED Integrado	20°	80	0.9	65	4	0.275
OU7027NBCA	Aleación Aluminio	■	4.3 W	196 lm	100-277 V ~	3 000 K	30000 h	Driver LED	LED Integrado	18°	90	0.75	65	6	0.82

OU7110GBCB

LED 6 WATTS 367 LUMENS 3000K 35° ANGULO APERTURA IP65 GRIS

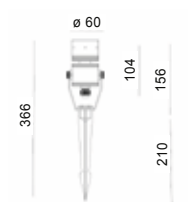

OU7111GBCB

LED 10 WATTS 1280 LUMENS 2700K 35° ANGULO APERTURA IP65 GRIS

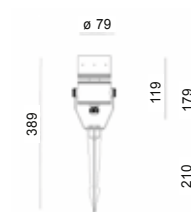

OU7112GBCB

LED 14 WATTS 1016 LUMENS 2700K 35° ANGULO APERTURA IP65 GRIS

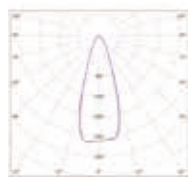
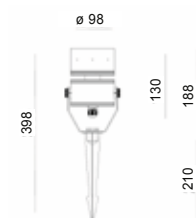

OU7113GBCB

LED 19 WATTS 1520 LUMENS 2700K 35° ANGULO APERTURA IP65 GRIS

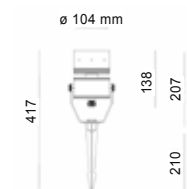

CÓDIGO	MATERIAL DE CUERPO	COLOR	POTENCIA	FLUJO LUMINOSO	ALIMENTACIÓN	TCC	VIDA ÚTIL(L80)	DRIVER	FUENTE DE LUZ	ÁNGULO DE APERTURA (VxH)	IRC	FP	IP	IK	PESO (KG)
OU7110GBCB	Aluminio	■	6 W	367 lm	127-220 V	■ 3 000 K	30 000 h	Driver electrónico	LED Integrado	35°	83	0.9	65	8	0.67
OU7111GBCB	Aluminio	■	10 W	1280 lm	127-220 V	■ 2 700 K	30 000 h	Driver electrónico	LED Integrado	35°	83	0.9	65	8	1.02
OU7112GBCB	Aluminio	■	14 W	1016 lm	127-220 V	■ 2 700 K	30 000 h	Driver electrónico	LED Integrado	35°	83	0.9	65	8	1.42
OU7113GBCB	Aluminio	■	19 W	1520 lm	127-220 V	■ 2 700 K	50 000 h	Driver electrónico	LED Integrado	35°	80	0.85	65	8	2

OU7064FBCA

LED 8 WATTS 670 LUMENS 3000K 60° ANGLULO APERTURA IP65 GRAFITO

ESTACA DESMONTABLE VISERA DESMONTABLE

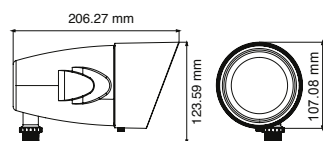
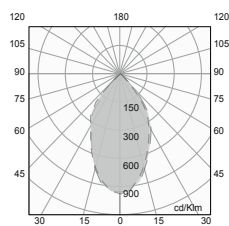

OU7065FBCA

LED 12 WATTS 910 LUMENS 3000K 60° ANGLULO APERTURA IP65 GRAFITO

ESTACA DESMONTABLE VISERA DESMONTABLE

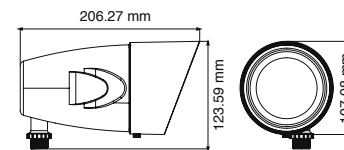
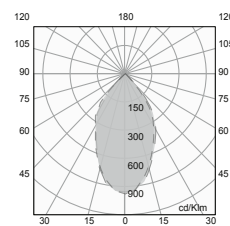

OU7024GBCB

LED 23 WATTS 1300 LUMENS 3000K 10° ANGLULO APERTURA IP65 GRIS

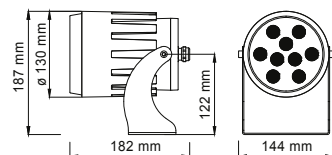
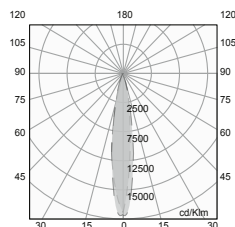

OU7025GBCB

LED 27 WATTS 1300 LUMENS 3000K 15° ANGLULO APERTURA IP65 GRIS

OU7025GBNB

LED 23 WATTS 1300 LUMENS 4000K 15° ANGLULO APERTURA IP65 GRIS

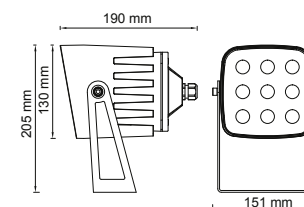
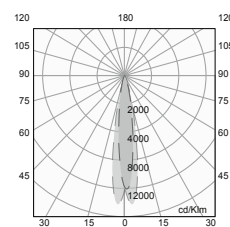

CÓDIGO	MATERIAL DE CUERPO	COLOR	POTENCIA	FLUJO LUMINOSO	ALIMENTACIÓN	TCC	VIDA ÚTIL (L80)	DRIVER	FUENTE DE LUZ	ÁNGULO DE APERTURA (VxH)	IRC	FP	IP	IK	PESO (KG)
OU7064FBCA	Aluminio	■	8 W	670 lm	127-277 V	■ 3 000 K	50 000 h	Driver electrónico	LED Integrado	60°	80	0.9	65	8	1.11
OU7065FBCA	Aluminio	■	12 W	910 lm	127-277 V	■ 3 000 K	30 000 h	Driver electrónico	LED Integrado	60°	80	0.9	65	8	1.11
OU7024GBCB	Aluminio	■	23 W	1300 lm	127-220 V	■ 3 000 K	50 000 h	Driver electrónico	LED Integrado	10°	80	0.9	65	8	1.3
OU7025GBCB	Aluminio	■	27 W	1300 lm	127-220 V	■ 3 000 K	50 000 h	Driver electrónico	LED Integrado	15°	80	0.9	65	8	1.6
OU7025GBNB	Aluminio	■	23 W	1300 lm	127-220 V	■ 4 000 K	50 000 h	Driver electrónico	LED Integrado	15°	80	0.9	65	8	2.2

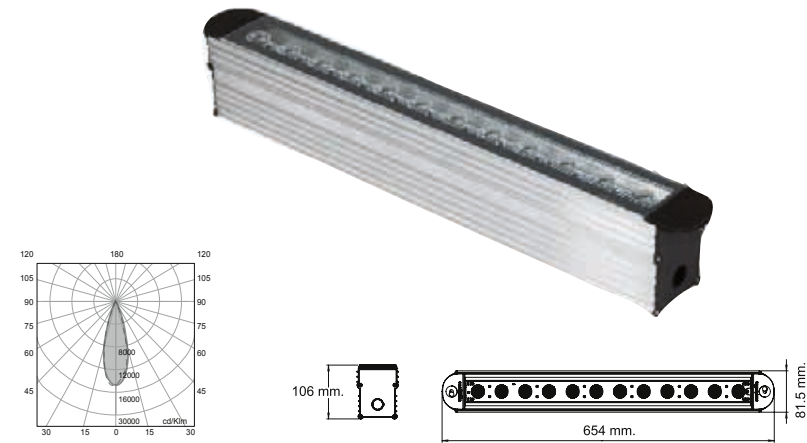
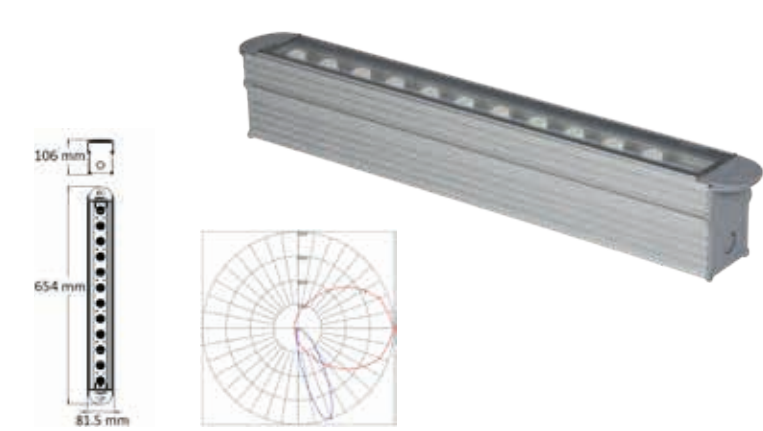
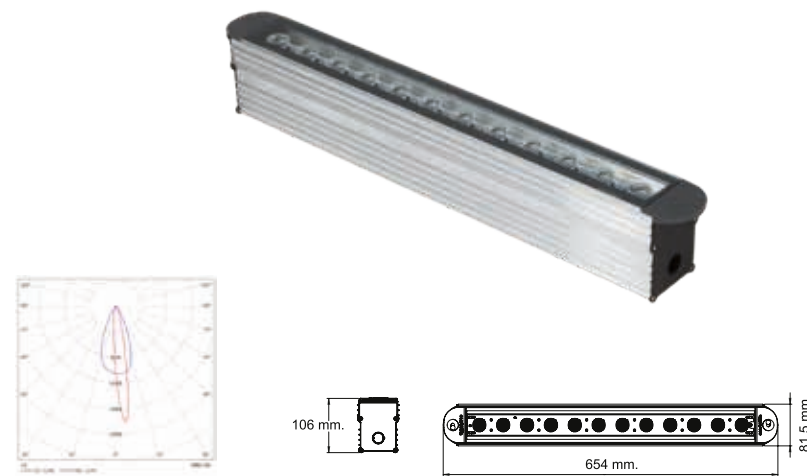
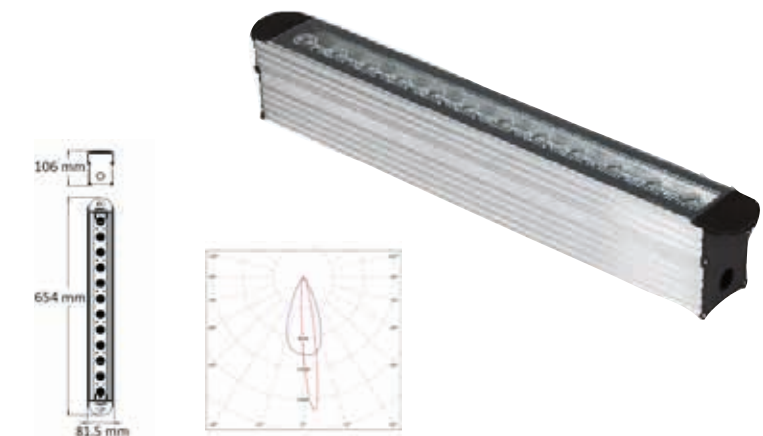

BARRA

OU3599GBCA**OU3599GBFA****OU3599GRGA****OU3606SBCA****OU3606SBFA****OU3606GRGA****OU3501GBCA****OU3601GBCA****OU3601GBFA****OU3601GRGA**

CÓDIGO	MATERIAL DE CUERPO	COLOR	POTENCIA	FLUJO LUMINOSO	ALIMENTACIÓN	TCC	VIDA ÚTIL (L80)	DRIVER	FUENTE DE LUZ	ÁNGULO DE APERTURA (VxH)	IRC	FP	IP	CORTE DE EMPOTRAMIENTO	IK	PESO (KG)
OU3599GBCA	Aluminio	■	50 W	4000 lm	127-277 V	■ 3 000 K	50 000 h	Driver electrónico	LED Integrado	30°	70	0.9	67	654X81.5X120 mm	9	3.7
OU3599GBFA	Aluminio	■	50 W	4000 lm	127-277 V	■ 5 000 K	50 000 h	Driver electrónico	LED Integrado	30°	70	0.95	67	654X81.5X120 mm	9	3.7
OU3599GRGA	Aluminio	■	50 W	-	127-277 V	-	50 000 h	Driver electrónico	LED Integrado	30°	-	0.9	67	-	9	3.7
OU3606SBCA	Aluminio	■	50 W	4000 lm	127-277 V	■ 3 000 K	50 000 h	Driver electrónico	LED Integrado	35x25°	70	0.9	67	654X81.5X120 mm	9	3.7
OU3606SBFA	Aluminio	■	50 W	4000 lm	127-277 V	■ 5 000 K	50 000 h	Driver electrónico	LED Integrado	35x25°	70	0.9	67	654X81.5X120 mm	9	3.7
OU3501GBCA	Aluminio	■	50 W	4000 lm	127-277 V	■ 3 000 K	50 000 h	Driver electrónico	LED Integrado	35x25°	70	0.9	67	644X81.5X120 mm	9	3.7
OU3601GBCA	Aluminio	■	50 W	4000 lm	127-277 V	■ 3 000 K	50 000 h	Driver electrónico	LED Integrado	10x40°	70	0.95	67	654X81.5X120 mm	9	3.7
OU3601GBFA	Aluminio	■	50 W	4000 lm	127-277 V	■ 5 000 K	50 000 h	Driver electrónico	LED Integrado	10x40°	70	0.95	67	654X81.5X120 mm	9	3.7
OU3601GRGA	Aluminio	■	50 W	-	127-277 V	-	50 000 h	Driver electrónico	LED Integrado	30°	-	0.9	67	-	9	3.7

OU3603GBCA

LED 90 WATTS 7800 LUMENS 3000K 30° ANGULO APERTURA IP67 GRIS

OU3603GBFA

LED 90 WATTS 7800 LUMENS 5000K 30° ANGULO APERTURA IP67 GRIS

OU3605GBCA

LED 90 WATTS 7800 LUMENS 3000K 10x40° ANGULO APERTURA IP67 GRIS

OU3605GBFA

LED 90 WATTS 7800 LUMENS 5000K 10x40° ANGULO APERTURA IP67 GRIS

OU3607SBCA

LED 90 WATTS 7800 LUMENS 3000K 35x25° ANGULO APERTURA IP67 GRIS

OU3607SBFA

LED 90 WATTS 7800 LUMENS 5000K 35x25° ANGULO APERTURA IP67 GRIS

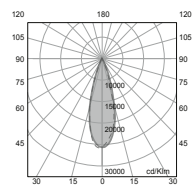

OU3603

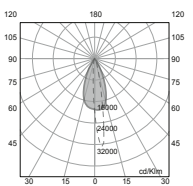

OU3605

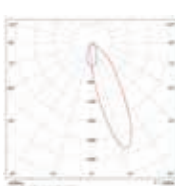

OU3607

92 mm

OU3700GBFA

LED 25 WATTS 3360 LUMENS 5000K 110° ANGULO APERTURA IP67 GRIS

OU3700GBNA

LED 25 WATTS 3360 LUMENS 4000K 110° ANGULO APERTURA IP67 GRIS

* Elemental

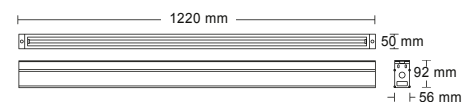
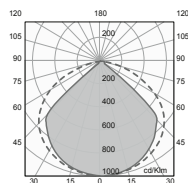

OU3701GBCA

LED 10 WATTS 1260 LUMENS 3000K 110° ANGULO APERTURA IP67 GRIS

OU3701GBFA

LED 10 WATTS 1260 LUMENS 5000K 110° ANGULO APERTURA IP67 GRIS

OU3701GBNA

LED 10 WATTS 1260 LUMENS 4000K 110° ANGULO APERTURA IP67 GRIS

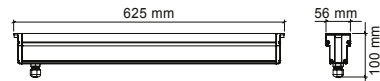
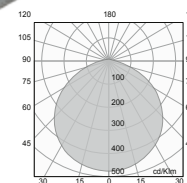

OU6023GAA

LED 33 WATTS 1471 LUMENS AMBAR 10x40° ANGULO APERTURA IP67 GRIS

OU6023GBCA

LED 33 WATTS 1471 LUMENS 3000K 10x40° ANGULO APERTURA IP67 GRIS

OU6023GBFA

LED 33 WATTS 1471 LUMENS 5000K 10x40° ANGULO APERTURA IP67 GRIS

* Incluye accesorio para sobreponer

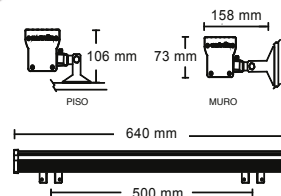
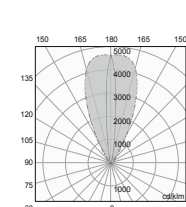
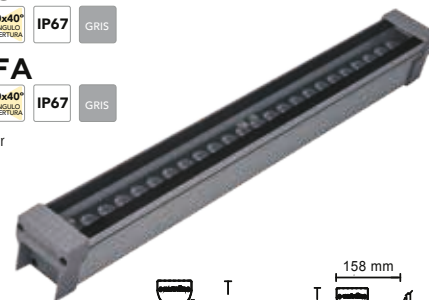

OU6031GBCA

LED 48 WATTS 3160 LUMENS 3000K 10x40° ANGULO APERTURA IP67 GRIS

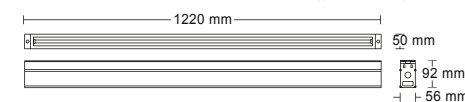
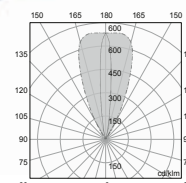
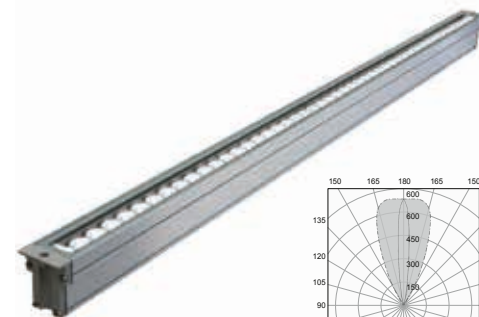

CÓDIGO	MATERIAL DE CUERPO	COLOR	POTENCIA	FLUJO LUMINOSO	ALIMENTACIÓN	TCC	VIDA ÚTIL (L80)	DRIVER	FUENTE DE LUZ	ÁNGULO DE APERTURA (VxH)	IRC	FP	IP	CORTE DE EMPOTRAMIENTO	IK	PESO (KG)
OU3603GBCA	Aluminio	■	90 W	7800 lm	127-277 V	3 000 K	50 000 h	Driver electrónico	LED Integrado	30°	70	0.95	67	1218X81.5X120 mm	9	3.7
OU3603GBFA	Aluminio	■	90 W	7800 lm	127-277 V	5 000 K	50 000 h	Driver electrónico	LED Integrado	30°	70	0.95	67	1218X81.5X120 mm	9	3.7
OU3605GBCA	Aluminio	■	90 W	7800 lm	127-277 V	3 000 K	50 000 h	Driver electrónico	LED Integrado	10x40°	70	0.95	67	1218X81.5X120 mm	9	3.7
OU3605GBFA	Aluminio	■	90 W	7800 lm	127-277 V	5 000 K	50 000 h	Driver electrónico	LED Integrado	10x40°	70	0.95	67	1218X81.5X120 mm	9	3.7
OU3607SBCA	Aluminio	■	90 W	7800 lm	127-277 V	3 000 K	50 000 h	Driver electrónico	LED Integrado	35x25°	70	0.9	67	1218X81.5X120 mm	9	3.7
OU3607SBFA	Aluminio	■	90 W	7800 lm	127-277 V	5 000 K	50 000 h	Driver electrónico	LED Integrado	35x25°	70	0.9	67	1218X81.5X120 mm	9	3.7
OU6023GAA	Aluminio	■	33 W	1471 lm	127-277 V	Ambar	25 000 h	Driver electrónico	LED Integrado	10x40°	-	0.9	67	NA	9	1.8
OU6023GBCA	Aluminio	■	33 W	1471 lm	127-277 V	3 000 K	25 000 h	Driver electrónico	LED Integrado	10x40°	80	0.9	67	NA	9	1.8
OU6023GBFA	Aluminio	■	33 W	1471 lm	127-277 V	5 000 K	25 000 h	Driver electrónico	LED Integrado	10x40°	80	0.9	67	NA	9	1.8
OU3700GBFA	Aluminio	■	25 W	3360 lm	127-277 V	5 000 K	40 000 h	Driver electrónico	LED Integrado	110°	80	0.9	67	1200X60X97 mm	9	1.6
OU3700GBNA	Aluminio	■	25 W	3360 lm	127-277 V	4 000 K	40 000 h	Driver electrónico	LED Integrado	110°	80	0.9	67	1200X60X97 mm	9	1.6
OU3701GBCA	Aluminio	■	10 W	1260 lm	127-277 V	3 000 K	40 000 h	Driver electrónico	LED Integrado	110°	80	0.98	67	600X60X97 mm	9	1.6
OU3701GBFA	Aluminio	■	10 W	1260 lm	127-277 V	5 000 K	40 000 h	Driver electrónico	LED Integrado	110°	80	0.98	67	600X60X97 mm	9	1.6
OU3701GBNA	Aluminio	■	10 W	1260 lm	127-277 V	4 000 K	40 000 h	Driver electrónico	LED Integrado	110°	80	0.98	67	600X60X97 mm	9	1.6
OU6031GBCA	Aluminio	■	48 W	3160 lm	127-277 V	3 000 K	25 000 h	Driver electrónico	LED Integrado	10x40°	80	0.9	67	1120.5X60x97 mm	9	5.2

OU6599GBCA

LED 50 WATTS 4000 LUMENS 3000K 30° ANGLULO APERTURA IP66 GRIS

OU6599GBFA

LED 50 WATTS 4000 LUMENS 5000K 30° ANGLULO APERTURA IP66 GRIS

OU6599GRGA

LED 50 WATTS 30° ANGLULO APERTURA IP66 SATINADO

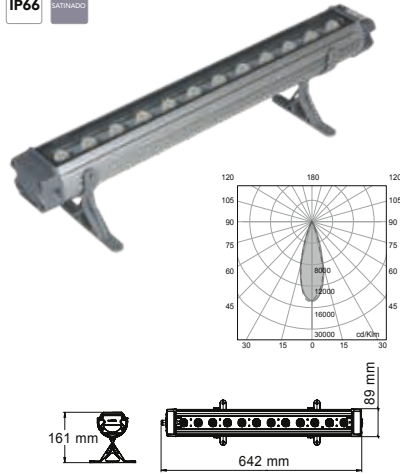

OU6601GBCA

LED 50 WATTS 4000 LUMENS 3000K 10x40° ANGLULO APERTURA IP66 GRIS

OU6601GBFA

LED 50 WATTS 4000 LUMENS 5000K 10x40° ANGLULO APERTURA IP66 GRIS

OU6601GRGA

LED 50 WATTS 30° ANGLULO APERTURA IP66 SATINADO

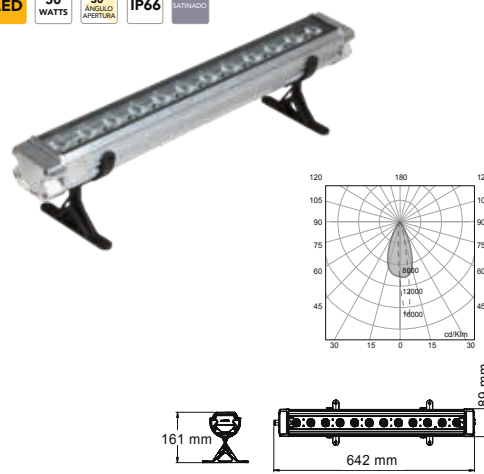

OU6606SBCA

LED 50 WATTS 4000 LUMENS 3000K 35x25° ANGLULO APERTURA IP66 GRIS

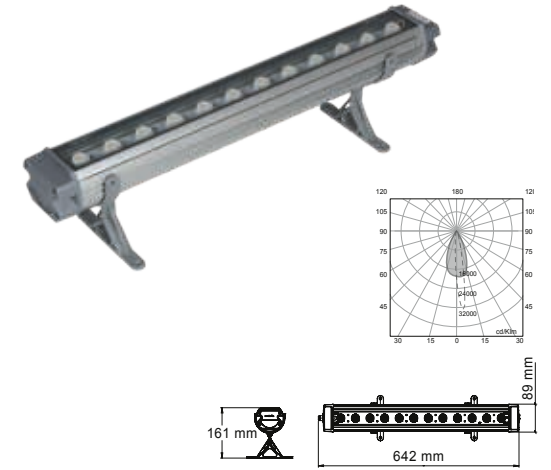

OU6603GBCA

LED 90 WATTS 7800 LUMENS 3000K 30° ANGLULO APERTURA IP66 GRIS

OU6603GBFA

LED 90 WATTS 7800 LUMENS 5000K 30° ANGLULO APERTURA IP66 GRIS

OU6605GBCA

LED 90 WATTS 7800 LUMENS 3000K 10x40° ANGLULO APERTURA IP66 GRIS

OU6605GBFA

LED 90 WATTS 7800 LUMENS 5000K 10x40° ANGLULO APERTURA IP66 GRIS

OU6607SBCA

LED 90 WATTS 7800 LUMENS 3000K 30° ANGLULO APERTURA IP66 GRIS



CÓDIGO	MATERIAL DE CUERPO	COLOR	POTENCIA	FLUJO LUMINOSO	ALIMENTACIÓN	TCC	VIDA ÚTIL (L80)	DRIVER	FUENTE DE LUZ	ÁNGULO DE APERTURA (vxh)	IRC	FP	IP	IK	PESO (KG)
OU6599GBCA	Aluminio	■	50 W	4000 lm	127-277 V	3 000 K	50 000 h	Driver electrónico	LED Integrado	30°	70	0.95	66	9	3.7
OU6599GBFA	Aluminio	■	50 W	4000 lm	127-277 V	5 000 K	50 000 h	Driver electrónico	LED Integrado	30°	70	0.95	66	9	3.7
OU6599GRGA	Aluminio	■	50 W	-	127-277 V	-	50 000 h	Driver electrónico	LED Integrado	30°	-	0.9	66	9	3.7
OU6601GBCA	Aluminio	■	50 W	4000 lm	127-277 V	3 000 K	50 000 h	Driver electrónico	LED Integrado	10x40°	70	0.95	66	9	3.7
OU6601GBFA	Aluminio	■	50 W	4000 lm	127-277 V	5 000 K	50 000 h	Driver electrónico	LED Integrado	10x40°	70	0.95	66	9	3.7
OU6601GRGA	Aluminio	■	50 W	-	127-277 V	-	50 000 h	Driver electrónico	LED Integrado	30°	-	0.9	66	9	3.7
OU6606SBCA	Aluminio	■	50 W	4000 lm	127-277 V	3 000 K	50 000 h	Driver electrónico	LED Integrado	35x25°	70	0.9	66	9	3.7
OU6603GBCA	Aluminio	■	90 W	7800 lm	127-277 V	3 000 K	50 000 h	Driver electrónico	LED Integrado	30°	70	0.95	66	9	3.7
OU6603GBFA	Aluminio	■	90 W	7800 lm	127-277 V	5 000 K	50 000 h	Driver electrónico	LED Integrado	30°	70	0.95	66	9	3.7
OU6605GBCA	Aluminio	■	90 W	7800 lm	127-277 V	3 000 K	50 000 h	Driver electrónico	LED Integrado	10x40°	70	0.95	66	9	3.7
OU6605GBFA	Aluminio	■	90 W	7800 lm	127-277 V	5 000 K	50 000 h	Driver electrónico	LED Integrado	10x40°	70	0.95	66	9	3.7
OU6607SBCA	Aluminio	■	90 W	7800 lm	127-277 V	3 000 K	50 000 h	Driver electrónico	LED Integrado	30°	70	0.9	66	9	3.7

OU6011GBFA

LED 58 WATTS 3180 LUMENS 5000K 23° ANGLULO APERTURA IP65 GRIS

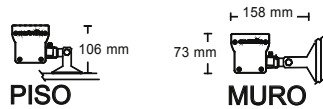
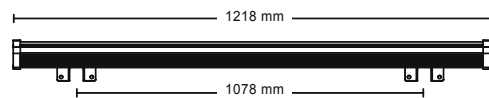

OU6024GBCA

LED 58 WATTS 3180 LUMENS 3000K 10x40° ANGLULO APERTURA IP65 GRIS

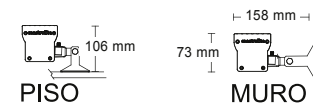
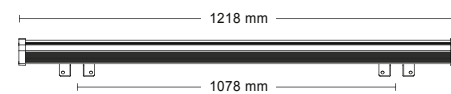

OU6608GBCA

LED 18 WATTS 2032 LUMENS 3000K 30° ANGLULO APERTURA IP65 GRIS

NUEVO

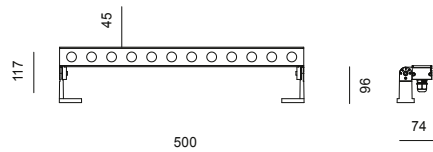
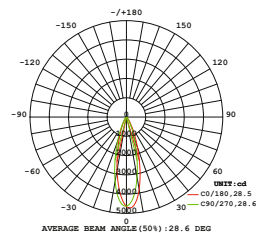

OU6609GBCA

LED 36 WATTS 3888 LUMENS 3000K 30° ANGLULO APERTURA IP65 GRIS

NUEVO

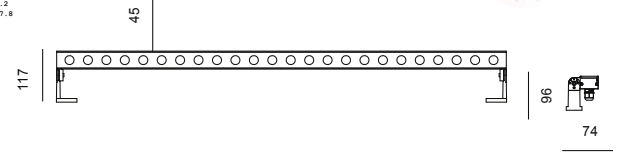
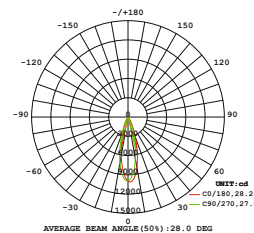

CÓDIGO	MATERIAL DE CUERPO	COLOR	POTENCIA	FLUJO LUMINOSO	ALIMENTACIÓN	TCC	VIDA ÚTIL(L80)	DRIVER	FUENTE DE LUZ	ÁNGULO DE APERTURA (VxH)	IRC	FP	IP	IK	PESO (KG)
OU6011GBFA	Aluminio	■	58 W	3180 lm	127-277 V	5 000 K	25 000 h	Driver electrónico	LED Integrado	23°	80	0.9	65	9	2.73
OU6024GBCA	Aluminio	■	58 W	3180 lm	127-277 V	3 000 K	25 000 h	Driver electrónico	LED Integrado	10x40°	80	0.9	65	9	3.4
OU6608GBCA	Aluminio	■	18 W	2032 lm	100-277 V ~	3 000 K	50000 h	Driver Electrónico	LED Integrado	30°	80	0.9	65	-	1.6
OU6609GBCA	Aluminio	■	36 W	3888 lm	100-277 V ~	3 000 K	50000 h	Driver Electrónico	LED Integrado	30°	80	0.9	65	-	2.5



ESTACIONES DE SERVICIO



IN4955BBFA

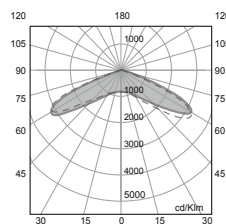
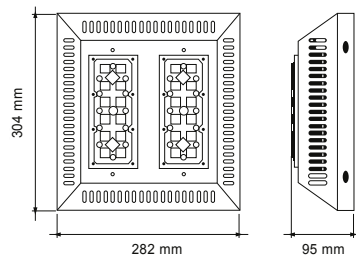

IN1955BBFA

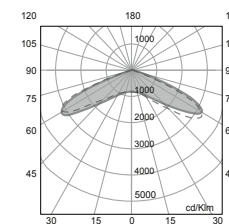
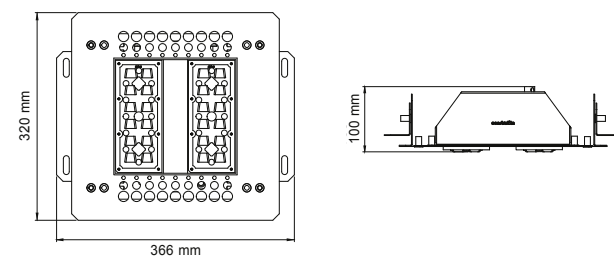

CÓDIGO	MATERIAL DE CUERPO	COLOR	POTENCIA	FLUJO LUMINOSO	ALIMENTACIÓN	TCC	VIDA ÚTIL (L80)	DRIVER	FUENTE DE LUZ	ÁNGULO DE APERTURA (VxH)	IRC	FP	IP	PESO (KG)
IN4955BBFA	Acero	☐	90 W	10290 lm	127-277 V	☐ 5 000 K	50 000 h	Driver electrónico	LED Integrado	Tipo V	70	0.9	65	2.8
IN1955BBFA	Acero	☐	90 W	10290 lm	127-277 V	☐ 5 000 K	50 000 h	Driver electrónico	LED Integrado	Tipo V	70	0.9	65	2.8

A nighttime photograph of an urban linear park. A wide, light-colored concrete path runs from the foreground into the distance. To the right of the path, a series of bright, rectangular lights are mounted on a low wall, creating a strong glow. In the background, city buildings and streetlights are visible against the dark sky. A large, dark, semi-circular graphic element is overlaid on the left side of the image.

LINEAL URBANO

OU7161FBFA

LED 25 WATTS 1700 LUMENS 5000K 20/170° ANGULO APERTURA IP65 GRAFITO

NUEVO

OU7161GBFA

LED 25 WATTS 1700 LUMENS 5000K 20/170° ANGULO APERTURA IP65 GRIS

* Método de sujeción en Parapeto 4" diámetro.

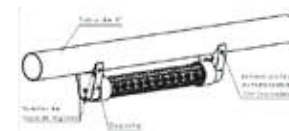
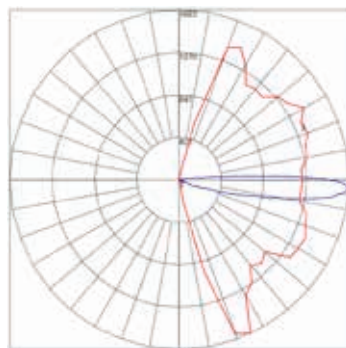
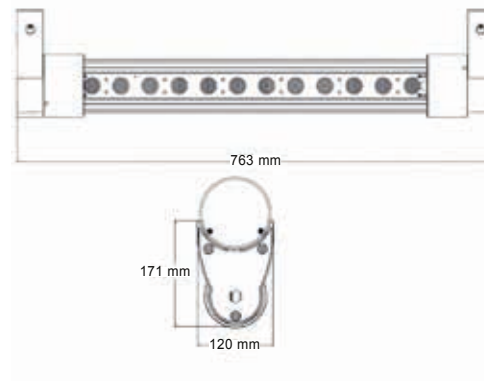

CÓDIGO	MATERIAL DE CUERPO	COLOR	POTENCIA	FLUJO LUMINOSO	ALIMENTACIÓN	TCC	VIDA ÚTIL (L80)	DRIVER	FUENTE DE LUZ	ÁNGULO DE APERTURA (VxH)	IRC	FP	IP	IK	PESO (KG)
OU7161FBFA	Aluminio	■	25 W	1700 lm	127-277 V	5 000 K	50 000 h	Driver electrónico	LED Integrado	20/170°	70	0.9	65	10	3.7
OU7161GBFA	Aluminio	■	25 W	1700 lm	127-277 V	5 000 K	50 000 h	Driver electrónico	LED Integrado	20/170°	70	0.9	65	10	3.7

ALUMBRADO PÚBLICO



OU9080FBNA

LED 75 WATTS 8100 LUMENS 4000K 120° ANGLULO APERTURA IP65 GRAFITO

* Espiga 80mm

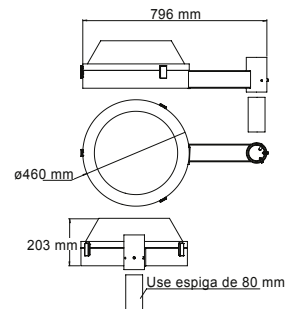
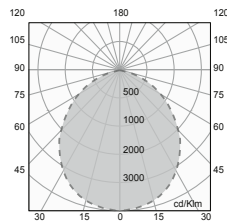

OU9087FBFA

LED 130 WATTS 13700 LUMENS 5000K Tipo II ANGLULO APERTURA IP65 GRAFITO

* Espiga 80mm

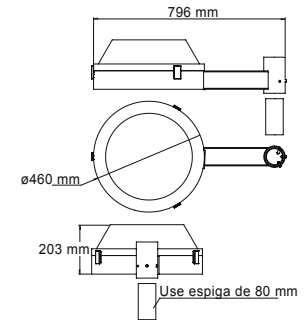
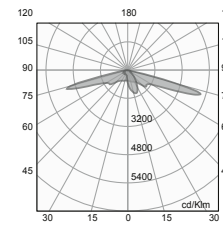

OU9086FBFA

LED 80 WATTS 9200 LUMENS 5000K Tipo II ANGLULO APERTURA IP65 GRAFITO

* Espiga 89mm

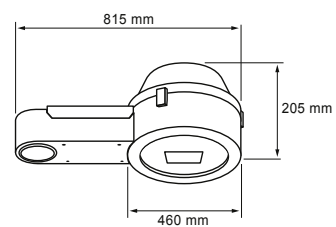
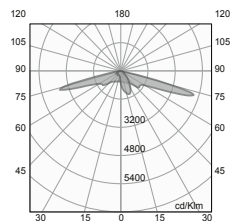

OU9201FBFA

LED 70 WATTS 7500 LUMENS 5000K Tipo V ANGLULO APERTURA IP65 GRAFITO

* Espiga 85mm

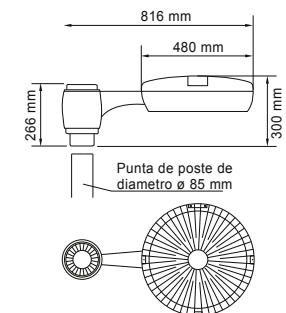
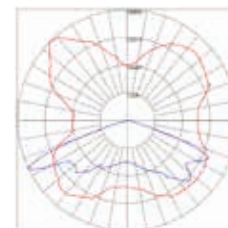

CÓDIGO	MATERIAL DE CUERPO	COLOR	POTENCIA	FLUJO LUMINOSO	ALIMENTACIÓN	TCC	VIDA ÚTIL (L80)	DRIVER	FUENTE DE LUZ	ÁNGULO DE APERTURA (vxH)	IRC	FP	IP	IK	PESO (KG)
OU9080FBNA	Aluminio	■	75 W	8100 lm	127-277 V	□ 4 000 K	50 000 h	Driver electrónico	LED Integrado	120°	85	0.95	65	10	13.4
OU9087FBFA	Aluminio	■	130 W	13700 lm	127-277 V	□ 5 000 K	50 000 h	Driver electrónico	LED Integrado	Tipo II	85	0.95	65	10	14
OU9086FBFA	Aluminio	■	80 W	9200 lm	127-277 V	□ 5 000 K	50 000 h	Driver electrónico	LED Integrado	Tipo II	85	0.95	65	10	14
OU9201FBFA	Aluminio	■	70 W	7500 lm	127-277 V	□ 5 000 K	50 000 h	Driver electrónico	LED Integrado	Tipo V	70	0.90	65	7	10.2

OU9041FBFA

LED 80 WATTS 8000 LUMENS 5000K Tipo V ANGULO APERTURA IP65 GRAFITO

OU9042FBFA

LED 80 WATTS 8000 LUMENS 5000K Tipo II ANGULO APERTURA IP65 GRAFITO



PARA POSTE LÁTIGO

* Espiga 42mm

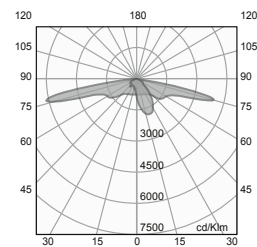

Tipo II

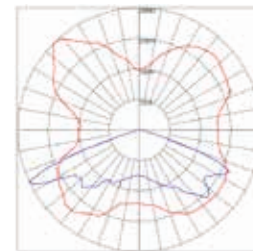

Tipo V

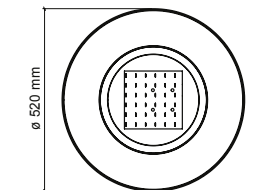
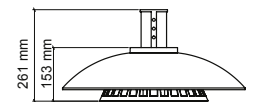
**OU9908FBFA**

LED 80 WATTS 9070 LUMENS 5000K Tipo V ANGULO APERTURA IP65 GRAFITO

OU9909FBFA

LED 80 WATTS 9070 LUMENS 5000K Tipo II ANGULO APERTURA IP65 GRAFITO



PARA POSTE LÁTIGO

* Espiga 42 mm

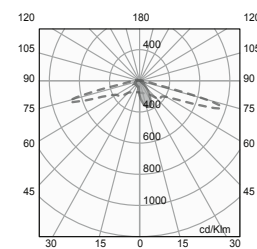

Tipo II

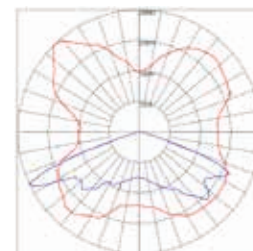

Tipo V

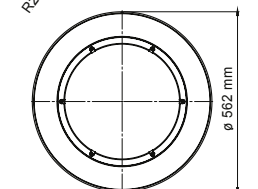
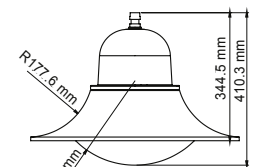

CÓDIGO	MATERIAL DE CUERPO	COLOR	POTENCIA	FLUJO LUMINOSO	ALIMENTACIÓN	TCC	VIDA ÚTIL(L80)	DRIVER	FUENTE DE LUZ	ÁNGULO DE APERTURA (vxH)	IRC	FP	IP	IK	PESO (KG)
OU9041FBFA	Aluminio	■	80 W	8000 lm	127-277 V	5 000 K	50 000 h	Driver electrónico	LED Integrado	Tipo V	70	0.95	65	4	7
OU9042FBFA	Aluminio	■	80 W	8000 lm	127-277 V	5 000 K	50 000 h	Driver electrónico	LED Integrado	Tipo II	70	0.95	65	4	7
OU9908FBFA	Aluminio	■	80 W	9070 lm	127-277 V	5 000 K	50 000 h	Driver electrónico	LED Integrado	Tipo V	70	0.95	65	7	5.2
OU9909FBFA	Aluminio	■	80 W	9070 lm	127-277 V	5 000 K	50 000 h	Driver electrónico	LED Integrado	Tipo II	70	0.95	65	7	5.2

OU9200FBFA

LED 70 WATTS 7500 LUMENS 5000K Tipo V ANGULO APERTURA IP65 GRAFITO

* Espiga 88mm



OU9023SBNB

LED 50 WATTS 5000 LUMENS 4000K 120° ANGULO APERTURA IP65 SATINADO

NUEVO

* Espiga 79mm



OU9100FBNA

LED 76 WATTS 8100 LUMENS 4000K 120° ANGULO APERTURA IP65 GRAFITO

* Espiga 76mm



OU9021FBNA

LED 80 WATTS 8000 LUMENS 4000K Tipo V ANGULO APERTURA IP65 GRAFITO

* Espiga 79mm



CÓDIGO	MATERIAL DE CUERPO	COLOR	POTENCIA	FLUJO LUMINOSO	ALIMENTACIÓN	TCC	VIDA ÚTIL(L80)	DRIVER	FUENTE DE LUZ	ÁNGULO DE APERTURA (VxH)	IRC	FP	IP	IK	PESO (KG)
OU9200FBFA	Aluminio	■	70 W	7500 lm	127-277 V	■ 5 000 K	50 000 h	Driver electrónico	LED Integrado	Tipo V	70	0.9	65	7	12.5
OU9023SBNB	Aluminio	■	50 W	5000 lm	100-240 V ~	■ 4 000 K	50000 h	Driver electrónico	LED Integrado	120°	90	0.9	65	8	9.5
OU9100FBNA	Aluminio	■	76 W	8100 lm	127-277 V	■ 4 000 K	50 000 h	Driver electrónico	LED Integrado	120°	85	0.95	65	10	17.6
OU9021FBNA	Aluminio	■	80 W	8000 lm	127-277 V	■ 4 000 K	50 000 h	Driver electrónico	LED Integrado	Tipo II	70	0.95	65	4	10

OU9035FBCA

LED 80 WATTS 7700 LUMENS 3000K Tipo V ANGULO DE APERTURA IP65 GRAFITO

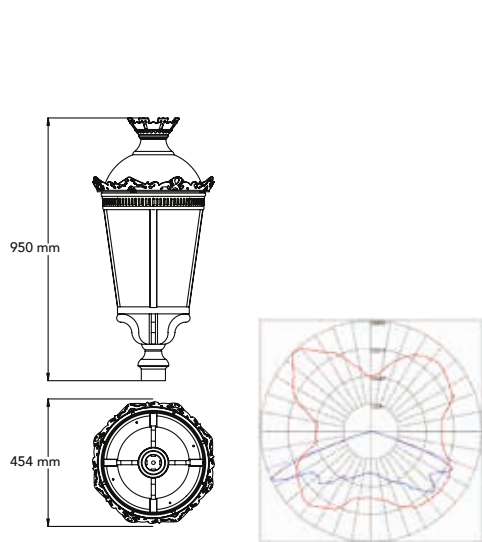

OU9036FBCA

LED 80 WATTS 7700 LUMENS 3000K Tipo III ANGULO DE APERTURA IP65 GRAFITO

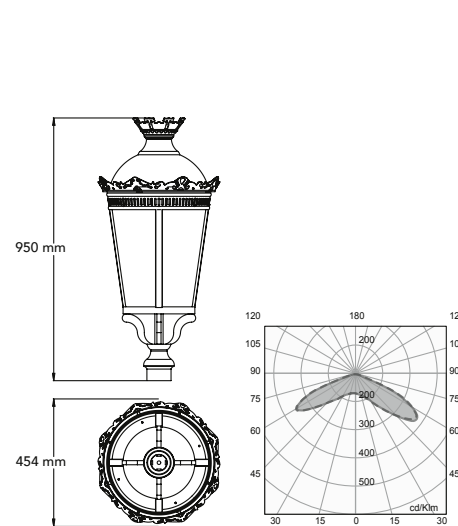

OU9906NBCA

LED 80 WATTS 7700 LUMENS 3000K Tipo V ANGULO DE APERTURA IP65 NEGRO

* Espiga 2.37 pulgadas

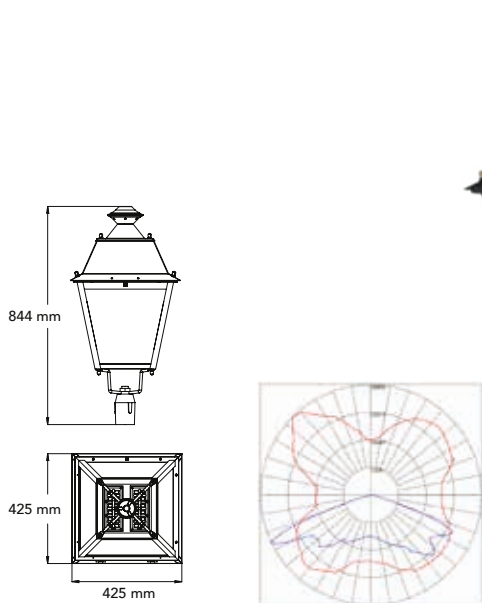

OU9907NBCA

LED 80 WATTS 7700 LUMENS 3000K Tipo III ANGULO DE APERTURA IP65 NEGRO

* Espiga 2.37 pulgadas

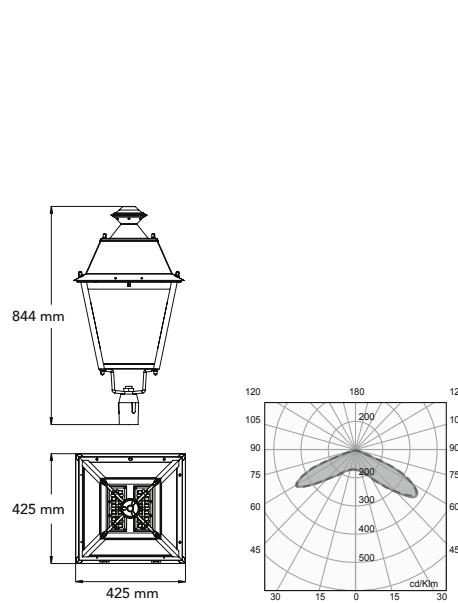

CÓDIGO	MATERIAL DE CUERPO	COLOR	POTENCIA	FLUJO LUMINOSO	ALIMENTACIÓN	TCC	VIDA ÚTIL(L80)	DRIVER	FUENTE DE LUZ	ÁNGULO DE APERTURA (vxH)	IRC	FP	IP	IK	PESO (KG)
OU9035FBCA	Aluminio	■	80 W	7700 lm	127-277 V	■ 3 000 K	50 000 h	Driver electrónico	LED Integrado	Tipo V	70	0.95	65	4	9.8
OU9036FBCA	Aluminio	■	80 W	7700 lm	127-277 V	■ 3 000 K	50 000 h	Driver electrónico	LED Integrado	Tipo III	70	0.95	65	4	9.8
OU9906NBCA	Aluminio	■	80 W	7700 lm	127-277 V	■ 3 000 K	50 000 h	Driver electrónico	LED Integrado	Tipo V	70	0.95	65	4	9
OU9907NBCA	Aluminio	■	80 W	7700 lm	127-277 V	■ 3 000 K	50 000 h	Driver electrónico	LED Integrado	Tipo III	70	0.95	65	4	9



A nighttime photograph of a modern urban street. The scene is dominated by tall, slender streetlights that cast a bright glow. In the background, a city skyline is visible with numerous lights. The foreground shows a paved road and a small landscaped area with a cactus. A large black circular graphic is overlaid on the left side of the image.

URBANO

V0052UN2M50

LED 51 WATTS 5000 LUMENS 5000K Tipo II ANGULO APERTURA IP65 GRIS



* Brazo para poste ajustable 33-73 mm

V0052UN3M50

LED 51 WATTS 5000 LUMENS 5000K Tipo III ANGULO APERTURA IP65 GRIS

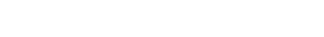

V0040UN2M50

LED 40 WATTS 4786 LUMENS 5000K Tipo II ANGULO APERTURA IP65 GRIS



* Brazo para poste ajustable 33-73 mm

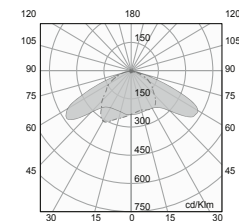
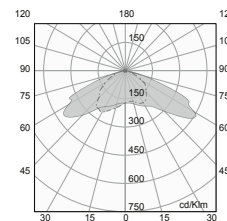
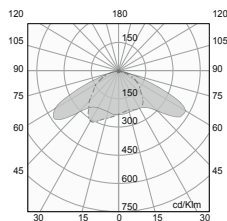
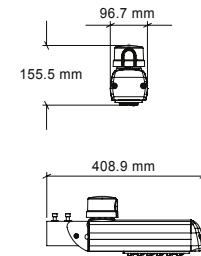
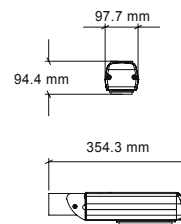
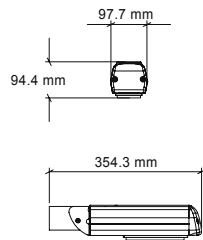
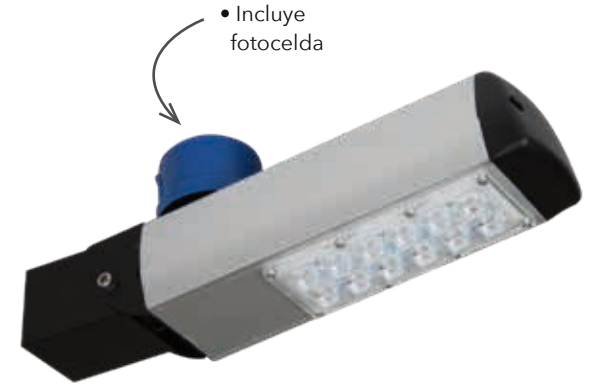

Se recomienda consultar la **NOM-013-ENER-2013** para determinar los niveles de iluminación aceptables para espacios de alumbrado público, así como la relación de uniformidad recomendada de acuerdo al tipo de vialidad.

CÓDIGO	MATERIAL DE CUERPO	COLOR	POTENCIA	FLUJO LUMINOSO	ALIMENTACIÓN	TCC	VIDA ÚTIL(L80)	DRIVER	FUENTE DE LUZ	ÁNGULO DE APERTURA (VxH)	IRC	FP	IP	IK	PESO (KG)
V0052UN2M50	Aluminio	■	51 W	4786 lm	127-277 V	■ 4 786 K	50 000 h	Driver electrónico	LED Integrado	Tipo II	70	0.9	65	8	2.2
V0052UN3M50	Aluminio	■	51 W	5000 lm	127-277 V	■ 5 000 K	50 000 h	Driver electrónico	LED Integrado	Tipo III	70	0.9	65	8	2.2
V0040UN2M50	Aluminio	■	40 W	4480 lm	127-277 V	■ 5 000 K	50 000 h	Driver electrónico	LED Integrado	Tipo II	70	0.9	65	8	2

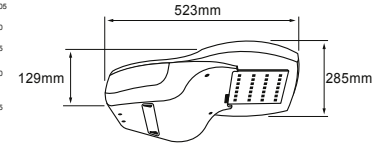
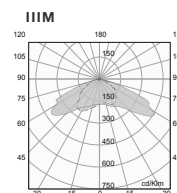
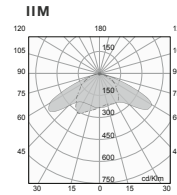
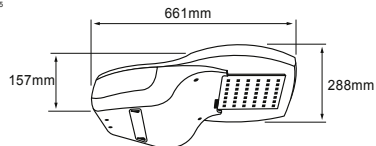
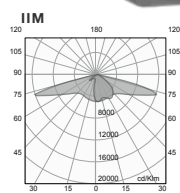
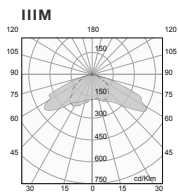
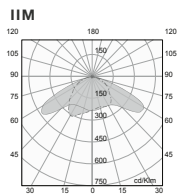

V2100UN2M40

LED 100 WATTS 11300 LUMENS 4000K Tipo II ANGULO APERTURA IP66 GRIS

V2100UN2M50

LED 100 WATTS 12763 LUMENS 5000K Tipo II ANGULO APERTURA IP66 GRIS

V2100UN3M40

LED 100 WATTS 11800 LUMENS 4000K Tipo III ANGULO APERTURA IP66 GRIS

V2100UN3M50

LED 100 WATTS 12600 LUMENS 5000K Tipo III ANGULO APERTURA IP66 GRIS



V2130UN2M40

LED 130 WATTS 16716 LUMENS 4000K Tipo II ANGULO APERTURA IP66 GRIS

V2130UN2M50

LED 130 WATTS 15800 LUMENS 5000K Tipo II ANGULO APERTURA IP66 GRIS



* Percha 60mm

V1050UN2M40

LED 50 WATTS 6621 LUMENS 4000K Tipo II ANGULO APERTURA IP66 GRIS

V1050UN2M50

LED 50 WATTS 6567 LUMENS 5000K Tipo II ANGULO APERTURA IP66 GRIS

V1050UN3M40

LED 50 WATTS 6400 LUMENS 4000K Tipo III ANGULO APERTURA IP66 GRIS

V1050UN3M50

LED 50 WATTS 6550 LUMENS 5000K Tipo III ANGULO APERTURA IP66 GRIS



* Percha 60mm

V1050UN2M50STG

LED 50 WATTS 6620 LUMENS 5000K Tipo II ANGULO APERTURA IP66 GRIS

* Percha 63mm

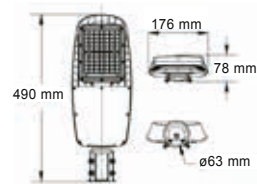
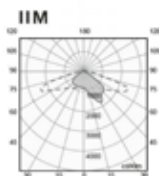

V2070UN2M40

LED 70 WATTS 8700 LUMENS 4000K Tipo II ANGULO APERTURA IP66 GRIS

V2070UN2M50

LED 70 WATTS 8800 LUMENS 5000K Tipo II ANGULO APERTURA IP66 GRIS

V2070UN3M40

LED 70 WATTS 9250 LUMENS 4000K Tipo III ANGULO APERTURA IP66 GRIS

V2070UN3M50

LED 70 WATTS 9700 LUMENS 5000K Tipo III ANGULO APERTURA IP66 GRIS

Se recomienda consultar la **NOM-013-ENER-2013** para determinar los niveles de iluminación aceptables para espacios de alumbrado público, así como la relación de uniformidad recomendada de acuerdo al tipo de vialidad.

CÓDIGO	MATERIAL DE CUERPO	COLOR	POTENCIA	FLUJO LUMINOSO	ALIMENTACIÓN	TCC	VIDA ÚTIL (L80)	DRIVER	FUENTE DE LUZ	ÁNGULO DE APERTURA (VxH)	IRC	FP	IP	IK	PESO (KG)
V2100UN2M40	Aluminio	■	100 W	11300 lm	127-277 V	□ 4 000 K	150 000 h	Driver electrónico	LED Integrado	Tipo II	70	0.95	66	10	8
V2100UN2M50	Aluminio	■	100 W	12763 lm	127-277 V	□ 5 000 K	150 000 h	Driver electrónico	LED Integrado	Tipo II	70	0.95	66	10	8
V2100UN3M40	Aluminio	■	100 W	11800 lm	127-277 V	□ 4 000 K	150 000 h	Driver electrónico	LED Integrado	Tipo III	70	0.95	66	10	8
V2100UN3M50	Aluminio	■	100 W	12600 lm	127-277 V	□ 5 000 K	150 000 h	Driver electrónico	LED Integrado	Tipo III	70	0.95	66	10	8
V2130UN2M40	Aluminio	■	130 W	16716 lm	127-277 V	□ 4 000 K	150 000 h	Driver electrónico	LED Integrado	Tipo II	70	0.95	66	10	12
V2130UN2M50	Aluminio	■	130 W	15800 lm	127-277 V	□ 5 000 K	150 000 h	Driver electrónico	LED Integrado	Tipo II	70	0.95	66	10	12
V1050UN2M40	Aluminio	■	50 W	6621 lm	127-277 V	□ 4 000 K	150 000 h	Driver electrónico	LED Integrado	Tipo II	70	0.95	66	10	8
V1050UN2M50	Aluminio	■	50 W	6567 lm	127-277 V	□ 5 000 K	150 000 h	Driver electrónico	LED Integrado	Tipo II	70	0.95	66	10	8
V1050UN3M40	Aluminio	■	50 W	6400 lm	127-277 V	□ 4 000 K	150 000 h	Driver electrónico	LED Integrado	Tipo III	70	0.95	66	10	8
V1050UN3M50	Aluminio	■	50 W	6550 lm	127-277 V	□ 5 000 K	150 000 h	Driver electrónico	LED Integrado	Tipo III	70	0.95	66	10	8
V2070UN2M40	Aluminio	■	70 W	8700 lm	127-277 V	□ 4 000 K	150 000 h	Driver electrónico	LED Integrado	Tipo II	70	0.95	66	10	8
V2070UN2M50	Aluminio	■	70 W	8800 lm	127-277 V	□ 5 000 K	150 000 h	Driver electrónico	LED Integrado	Tipo II	70	0.95	66	10	8
V2070UN3M40	Aluminio	■	70 W	9250 lm	127-277 V	□ 4 000 K	150 000 h	Driver electrónico	LED Integrado	Tipo III	70	0.95	66	10	8
V2070UN3M50	Aluminio	■	70 W	9700 lm	127-277 V	□ 5 000 K	150 000 h	Driver electrónico	LED Integrado	Tipo III	70	0.95	66	10	8
V1050UN2M50STG	Aluminio	■	50 W	6620 lm	127-277 V	□ 5 000 K	150 000 h	Driver electrónico	LED Integrado	Tipo II	70	0.95	66	10	3.2

* Supresor de picos 10Kva

V2070UN2M50

LED	70 WATTS	8050 LUMENS	5000K	Tipo II ÁNGULO APERTURA	IP66	GRIS
-----	----------	-------------	-------	-------------------------------	------	------

V2085UN2M50

LED	85 WATTS	9350 LUMENS	5000K	Tipo II ÁNGULO APERTURA	IP66	GRIS
-----	----------	-------------	-------	-------------------------------	------	------

V3160UN2M40

LED	160 WATTS	20650 LUMENS	4000K	Tipo II ÁNGULO APERTURA	IP66	GRIS
-----	-----------	--------------	-------	-------------------------------	------	------

V3160UN2M50

LED	160 WATTS	22400 LUMENS	5000K	Tipo II ÁNGULO APERTURA	IP66	GRIS
-----	-----------	--------------	-------	-------------------------------	------	------

V3160UN3M40

LED	160 WATTS	20650 LUMENS	4000K	Tipo III ÁNGULO APERTURA	IP66	GRIS
-----	-----------	--------------	-------	--------------------------------	------	------

V3200UN3M50

LED	195 WATTS	26100 LUMENS	5000K	Tipo III ÁNGULO APERTURA	IP66	GRIS
-----	-----------	--------------	-------	--------------------------------	------	------



* Percha 60mm

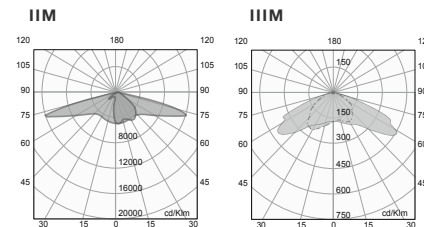
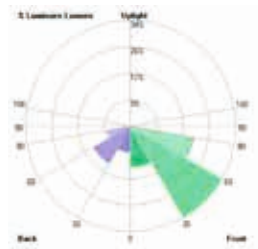
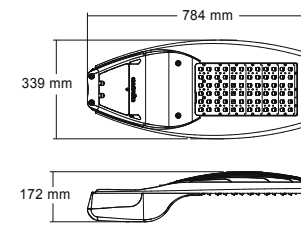
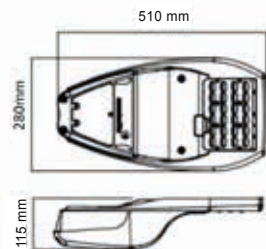

Se recomienda consultar la **NOM-013-ENER-2013** para determinar los niveles de iluminación aceptables para espacios de alumbrado público, así como la relación de uniformidad recomendada de acuerdo al tipo de vialidad.

CÓDIGO	MATERIAL DE CUERPO	COLOR	POTENCIA	FLUJO LUMINOSO	ALIMENTACIÓN	TCC	VIDA ÚTIL (L80)	DRIVER	FUENTE DE LUZ	ÁNGULO DE APERTURA (VxH)	IRC	FP	IP	IK	PESO (KG)
V2070UN2M50	Aluminio	Gris	70 W	8050 lm	127-277 V	5000 K	150 000 h	Driver electrónico	LED Integrado	Tipo 2	70	0.95	66	10	3.8
V2085UN2M50	Aluminio	Gris	85 W	9350 lm	127-277 V	5000 K	150 000 h	Driver electrónico	LED Integrado	Tipo 2	70	0.95	66	10	3.8
V3160UN2M40	Aluminio	■	160 W	20650 lm	127-277 V	4 000 K	150 000 h	Driver electrónico	LED Integrado	Tipo II	70	0.95	66	10	12
V3160UN2M50	Aluminio	■	160 W	22400 lm	127-277 V	5 000 K	150 000 h	Driver electrónico	LED Integrado	Tipo II	70	0.95	66	10	12
V3160UN3M40	Aluminio	■	160 W	20650 lm	127-277 V	4 000 K	150 000 h	Driver electrónico	LED Integrado	Tipo III	70	0.95	66	10	12
V3200UN3M50	Aluminio	■	195 W	26100 lm	127-277 V	5 000 K	150 000 h	Driver electrónico	LED Integrado	Tipo III	70	0.95	66	10	12

* Supresor de pico 10Kva

*Construlita se reserva el derecho de modificar la información sin previo aviso y no se hace responsable por errores u omisiones en este documento.

OU6066NBNA

LED 180 WATTS 29350 LUMENS 5000K Tipo III ANGULO APERTURA IP65 NEGRO

* Percha 60mm

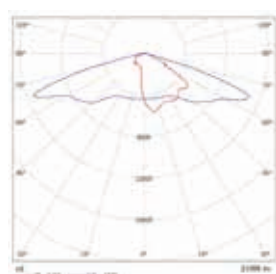
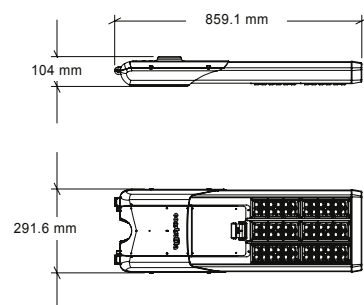

OU6068NBNA

LED 180 WATTS 21570 LUMENS 5000K Tipo V ANGULO APERTURA IP65 NEGRO

* Percha 60mm

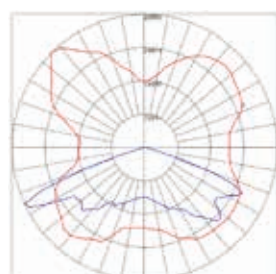
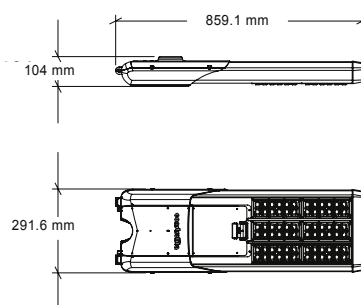

V4305UN3M50

LED 245 WATTS 29350 LUMENS 5000K Tipo III ANGULO APERTURA IP65 GRIS

* Percha 60mm

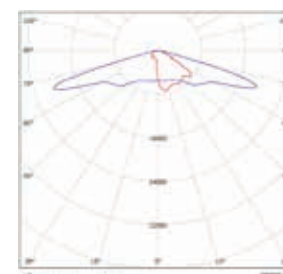
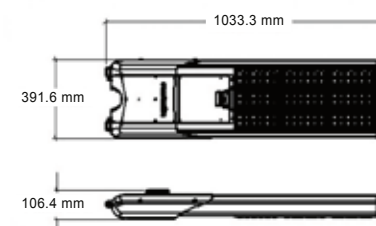

Se recomienda consultar la **NOM-013-ENER-2013** para determinar los niveles de iluminación aceptables para espacios de alumbrado público, así como la relación de uniformidad recomendada de acuerdo al tipo de vialidad.

CÓDIGO	MATERIAL DE CUERPO	COLOR	POTENCIA	FLUJO LUMINOSO	ALIMENTACIÓN	TCC	VIDA ÚTIL(L80)	DRIVER	FUENTE DE LUZ	ÁNGULO DE APERTURA (VxH)	IRC	FP	IP	IK	PESO (KG)
OU6066NBNA	Aluminio	■	180 W	21570 lm	127-277 V	5 000 K	50 000 h	Driver electrónico	LED Integrado	Tipo III	70	0.95	65	7	8.5
OU6068NBNA	Aluminio	■	180 W	21570 lm	127-277 V	5 000 K	50 000 h	Driver electrónico	LED Integrado	Tipo V	70	0.95	65	7	8.5
V4305UN3M50	Aluminio	■	245 W	29350 lm	127-277 V	5 000 K	50 000 h	Driver electrónico	LED Integrado	Tipo III	70	0.97	65	8	10

* Supresor de pico 10Kva





**PROYECTOR
MODULÉ**

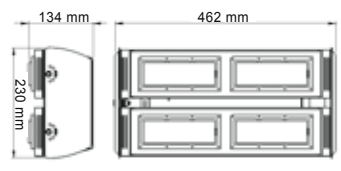

ML8420NBFCN
 LED 180 WATTS 18900 LUMENS 5000K 60° ANGULO APERTURA IP65 NEGRO

ML8420NBFCO
 LED 180 WATTS 18900 LUMENS 5000K 90° ANGULO APERTURA IP65 NEGRO

NUEVO

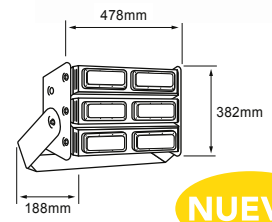

NUEVO

ML6630NBFCO
 LED 270 WATTS 28350 LUMENS 5000K 15° ANGULO APERTURA IP65 NEGRO

ML6630NBFCM
 LED 270 WATTS 28350 LUMENS 5000K 30° ANGULO APERTURA IP65 NEGRO

ML6630NBFCN
 LED 270 WATTS 28350 LUMENS 5000K 60° ANGULO APERTURA IP65 NEGRO

ML6630NBFCO
 LED 270 WATTS 29700 LUMENS 5000K 90° ANGULO APERTURA IP65 NEGRO

ML6630NBNCCK
 LED 270 WATTS 28350 LUMENS 4000K 15° ANGULO APERTURA IP65 NEGRO

ML6630NBNCM
 LED 270 WATTS 28350 LUMENS 4000K 30° ANGULO APERTURA IP65 NEGRO

ML6630NBNCN
 LED 270 WATTS 28350 LUMENS 4000K 40° ANGULO APERTURA IP65 NEGRO

ML6630NBNCO
 LED 270 WATTS 28350 LUMENS 4000K 90° ANGULO APERTURA IP65 NEGRO

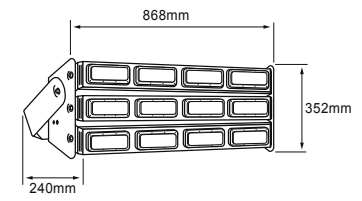
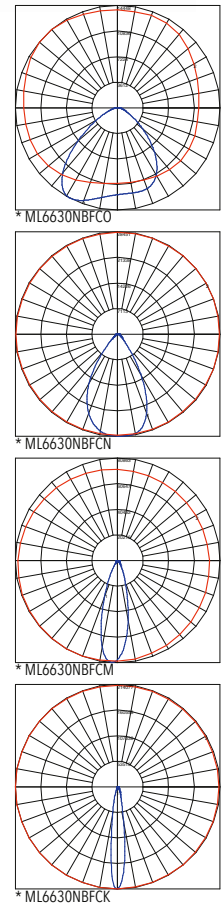

NUEVO

ML6C60NBFCO
 LED 540 WATTS 62000 LUMENS 5000K 15° ANGULO APERTURA IP65 NEGRO

ML6C60NBFCM
 LED 540 WATTS 62000 LUMENS 5000K 30° ANGULO APERTURA IP65 NEGRO

ML6C60NBFCN
 LED 540 WATTS 62000 LUMENS 5000K 60° ANGULO APERTURA IP65 NEGRO

ML6C60NBFCO
 LED 540 WATTS 62000 LUMENS 5000K 90° ANGULO APERTURA IP65 NEGRO

ML6C60NBNCCK
 LED 540 WATTS 62000 LUMENS 4000K 15° ANGULO APERTURA IP65 NEGRO

ML6C60NBNCM
 LED 540 WATTS 62000 LUMENS 4000K 30° ANGULO APERTURA IP65 NEGRO

ML6C60NBNCN
 LED 540 WATTS 62000 LUMENS 4000K 40° ANGULO APERTURA IP65 NEGRO

ML6C60NBNCO
 LED 540 WATTS 62000 LUMENS 4000K 90° ANGULO APERTURA IP65 NEGRO

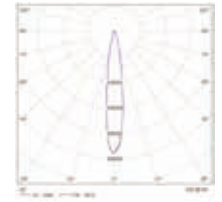

CÓDIGO	MATERIAL DE CUERPO	COLOR	POTENCIA	FLUJO LUMINOSO	ALIMENTACIÓN	TCC	VIDA ÚTIL (L80)	DRIVER	FUENTE DE LUZ	ÁNGULO DE APERTURA (v x h)	IRC	FP	IP	IK	PESO (KG)
ML8420NBFCN	Acero	■	180 W	20700 lm	127-277 V	5 000 K	50 000 h	Driver electrónico	LED Integrado	60°	70	0.95	65	8	3
ML8420NBFCO	Acero	■	180 W	20700 lm	127-277 V	5 000 K	50 000 h	Driver electrónico	LED Integrado	90°	70	0.95	65	8	3
ML6630NBFCCK	Acero	■	270 W	31050 lm	127-277 V	5 000 K	50 000 h	Driver electrónico	LED Integrado	15°	70	0.95	65	8	4.5
ML6630NBFCM	Acero	■	270 W	31050 lm	127-277 V	5 000 K	50 000 h	Driver electrónico	LED Integrado	30°	70	0.95	65	8	4.8
ML6630NBFCN	Acero	■	270 W	31050 lm	127-277 V	5 000 K	50 000 h	Driver electrónico	LED Integrado	60°	70	0.95	65	8	4.8
ML6630NBFCO	Acero	■	270 W	31050 lm	127-277 V	5 000 K	50 000 h	Driver electrónico	LED Integrado	90°	70	0.95	65	8	4.5
ML6630NBNCCK	Acero	■	270 W	31050 lm	127-277 V	4 000 K	50 000 h	Driver electrónico	LED Integrado	15°	70	0.95	65	8	4.5
ML6630NBNCM	Acero	■	270 W	31050 lm	127-277 V	4 000 K	50 000 h	Driver electrónico	LED Integrado	30°	70	0.95	65	8	4.5
ML6630NBNCN	Acero	■	270 W	31050 lm	127-277 V	4 000 K	50 000 h	Driver electrónico	LED Integrado	60°	70	0.95	65	8	4.5
ML6630NBNCO	Acero	■	270 W	31050 lm	127-277 V	4 000 K	50 000 h	Driver electrónico	LED Integrado	90°	70	0.95	65	8	4.5
ML6C60NBFCCK	Acero	■	540 W	62000 lm	127-277 V	5 000 K	50 000 h	Driver electrónico	LED Integrado	15°	70	0.95	65	8	7
ML6C60NBFCM	Acero	■	540 W	62100 lm	127-277 V	5 000 K	50 000 h	Driver electrónico	LED Integrado	30°	70	0.95	65	8	7
ML6C60NBFCN	Acero	■	540 W	62100 lm	127-277 V	5 000 K	50 000 h	Driver electrónico	LED Integrado	60°	70	0.95	65	8	7
ML6C60NBFCO	Acero	■	540 W	62100 lm	127-277 V	5 000 K	50 000 h	Driver electrónico	LED Integrado	90°	70	0.95	65	8	7
ML6C60NBNCCK	Acero	■	540 W	62100 lm	127-277 V	4 000 K	50 000 h	Driver electrónico	LED Integrado	15°	70	0.95	65	8	7
ML6C60NBNCM	Acero	■	540 W	62100 lm	127-277 V	4 000 K	50 000 h	Driver electrónico	LED Integrado	30°	70	0.95	65	8	7
ML6C60NBNCN	Acero	■	540 W	62100 lm	127-277 V	4 000 K	50 000 h	Driver electrónico	LED Integrado	60°	70	0.95	65	8	7
ML6C60NBNCO	Acero	■	540 W	62100 lm	127-277 V	4 000 K	50 000 h	Driver electrónico	LED Integrado	90°	70	0.95	65	8	7

*Construlita se reserva el derecho de modificar la información sin previo aviso y no se hace responsable por errores u omisiones en este documento.

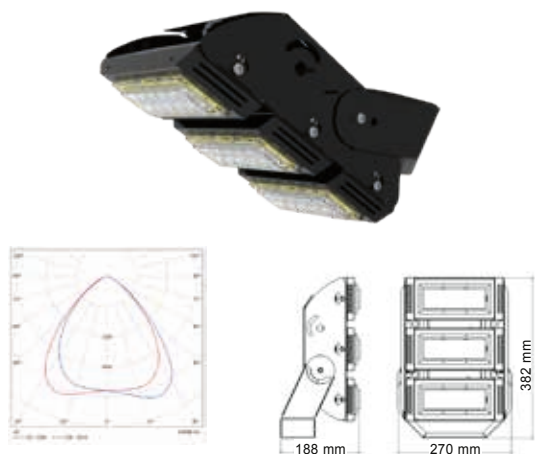
**ML6315NBF CW**

LED 135 WATTS 15530 LUMENS 5000K 19° 27' 56" ANGLULO APERTURA IP65 NEGRO

ML6315NBF CO

LED 135 WATTS 15530 LUMENS 5000K 90° ANGLULO APERTURA IP65 NEGRO

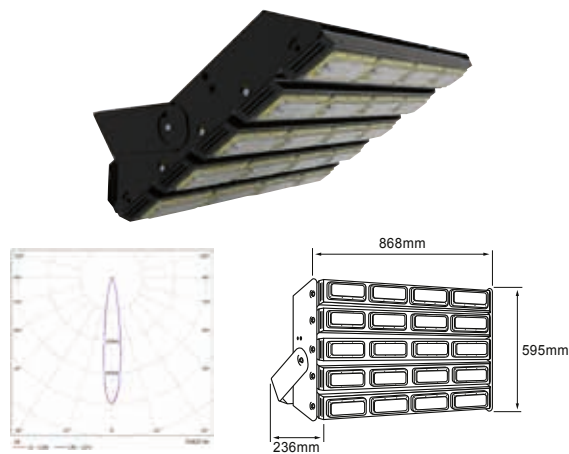
**ML6K80NBF CK**

LED 800 WATTS 92000 LUMENS 5000K 15° ANGLULO APERTURA IP65 NEGRO

ML6K80NBF CM

LED 800 WATTS 92000 LUMENS 5000K 30° ANGLULO APERTURA IP65 NEGRO

ML6K80NBF CN

LED 800 WATTS 92000 LUMENS 5000K 60° ANGLULO APERTURA IP65 NEGRO

ML6K80NBF CO

LED 800 WATTS 92000 LUMENS 5000K 90° ANGLULO APERTURA IP65 NEGRO

ML6K80NBN CK

LED 800 WATTS 92000 LUMENS 4000K 15° ANGLULO APERTURA IP65 NEGRO

ML6K80NBN CM

LED 800 WATTS 92000 LUMENS 4000K 30° ANGLULO APERTURA IP65 NEGRO

ML6K80NBN CN

LED 800 WATTS 92000 LUMENS 4000K 60° ANGLULO APERTURA IP65 NEGRO

ML6K80NBN CO

LED 800 WATTS 92000 LUMENS 4000K 90° ANGLULO APERTURA IP65 NEGRO

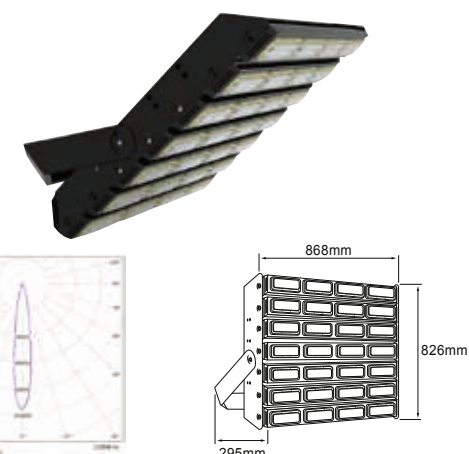
**ML6S12NBF CK**

LED 1200 WATTS 138000 LUMENS 5000K 15° ANGLULO APERTURA IP65 NEGRO

ML6S12NBF CM

LED 1200 WATTS 138000 LUMENS 5000K 30° ANGLULO APERTURA IP65 NEGRO

ML6S12NBF CN

LED 1200 WATTS 138000 LUMENS 5000K 60° ANGLULO APERTURA IP65 NEGRO

ML6S12NBF CO

LED 1200 WATTS 138000 LUMENS 5000K 90° ANGLULO APERTURA IP65 NEGRO

ML6S12NBN CK

LED 1200 WATTS 138000 LUMENS 4000K 15° ANGLULO APERTURA IP65 NEGRO

ML6S12NBN CM

LED 1200 WATTS 138000 LUMENS 4000K 30° ANGLULO APERTURA IP65 NEGRO

ML6S12NBN CN

LED 1200 WATTS 138000 LUMENS 4000K 60° ANGLULO APERTURA IP65 NEGRO

ML6S12NBN CO

LED 1200 WATTS 138000 LUMENS 4000K 90° ANGLULO APERTURA IP65 NEGRO

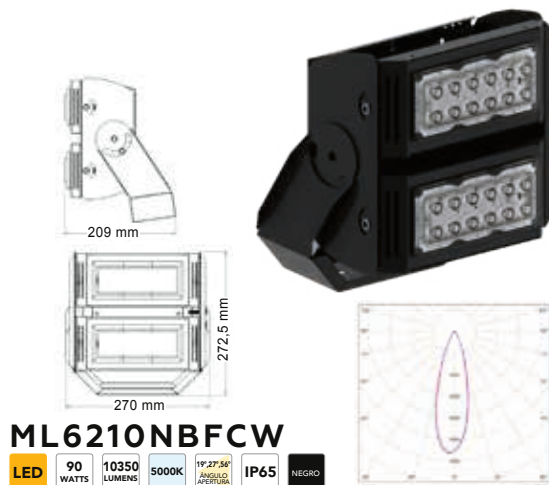
**ML6210NBF CW**

LED 90 WATTS 10350 LUMENS 5000K 19° 27' 56" ANGLULO APERTURA IP65 NEGRO

CÓDIGO	MATERIAL DE CUERPO	COLOR	POTENCIA	FLUJO LUMINOSO	ALIMENTACIÓN	TCC	VIDA ÚTIL (L80)	DRIVER	FUENTE DE LUZ	ÁNGULO DE APERTURA (VxH)	IRC	FP	IP	IK	PESO (KG)
ML6315NBF CW	Acero	■	135 W	15530 lm	127-277 V	5 000 K	50 000 h	Driver electrónico	LED Integrado	19°, 27°, 56°	70	0.95	65	8	2.6
ML6315NBF CO	Acero	■	135 W	15530 lm	127-277 V	5 000 K	50 000 h	Driver electrónico	LED Integrado	90°	70	0.95	65	8	2.6
ML6210NBF CW	Acero	■	90 W	10350 lm	127-277 V	5 000 K	50 000 h	Driver electrónico	LED Integrado	19°, 27°, 56°	70	0.95	65	8	2.6
ML6K80NBF CK	Acero	■	800 W	92000 lm	127-277 V	5 000 K	50 000 h	Driver electrónico	LED Integrado	15°	70	0.95	65	8	11
ML6K80NBF CM	Acero	■	800 W	92000 lm	127-277 V	5 000 K	50 000 h	Driver electrónico	LED Integrado	30°	70	0.95	65	8	11
ML6K80NBF CN	Acero	■	800 W	92000 lm	127-277 V	5 000 K	50 000 h	Driver electrónico	LED Integrado	60°	70	0.95	65	8	11
ML6K80NBF CO	Acero	■	800 W	92000 lm	127-277 V	5 000 K	50 000 h	Driver electrónico	LED Integrado	90°	70	0.95	65	8	11
ML6K80NBN CK	Acero	■	800 W	92000 lm	127-277 V	4 000 K	50 000 h	Driver electrónico	LED Integrado	15°	70	0.95	65	8	11
ML6K80NBN CM	Acero	■	800 W	92000 lm	127-277 V	4 000 K	50 000 h	Driver electrónico	LED Integrado	30°	70	0.95	65	8	11
ML6K80NBN CN	Acero	■	800 W	92000 lm	127-277 V	4 000 K	50 000 h	Driver electrónico	LED Integrado	60°	70	0.95	65	8	11
ML6K80NBN CO	Acero	■	800 W	92000 lm	127-277 V	4 000 K	50 000 h	Driver electrónico	LED Integrado	90°	70	0.95	65	8	11
ML6S12NBF CK	Acero	■	1200 W	138000 lm	127-277 V	5 000 K	50 000 h	Driver electrónico	LED Integrado	15°	70	0.95	65	8	15
ML6S12NBF CM	Acero	■	1200 W	138000 lm	127-277 V	5 000 K	50 000 h	Driver electrónico	LED Integrado	30°	70	0.95	65	8	15
ML6S12NBF CN	Acero	■	1200 W	138000 lm	127-277 V	5 000 K	50 000 h	Driver electrónico	LED Integrado	60°	70	0.95	65	8	15
ML6S12NBF CO	Acero	■	1200 W	138000 lm	127-277 V	5 000 K	50 000 h	Driver electrónico	LED Integrado	90°	70	0.95	65	8	15
ML6S12NBN CK	Acero	■	1200 W	138000 lm	127-277 V	4 000 K	50 000 h	Driver electrónico	LED Integrado	15°	70	0.95	65	8	15
ML6S12NBN CM	Acero	■	1200 W	138000 lm	127-277 V	4 000 K	50 000 h	Driver electrónico	LED Integrado	30°	70	0.95	65	8	15
ML6S12NBN CN	Acero	■	1200 W	138000 lm	127-277 V	4 000 K	50 000 h	Driver electrónico	LED Integrado	60°	70	0.95	65	8	15
ML6S12NBN CO	Acero	■	1200 W	138000 lm	127-277 V	4 000 K	50 000 h	Driver electrónico	LED Integrado	90°	70	0.95	65	8	15

OU7103NBFA

LED 400 WATTS 35508 LUMENS 5000K 80° ANGLULO APERTURA IP65 NEGRO

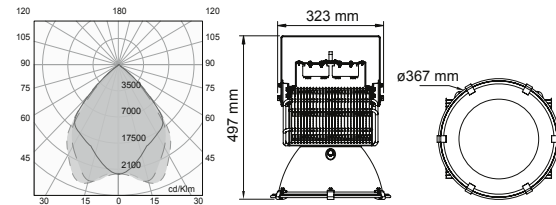

OU7074NBFA

LED 450 WATTS 44200 LUMENS 5000K 85x135° ANGLULO APERTURA IP65 NEGRO

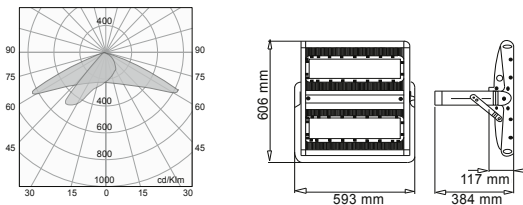

OU7076NBFA

LED 670 WATTS 65780 LUMENS 5000K 85x135° ANGLULO APERTURA IP65 NEGRO

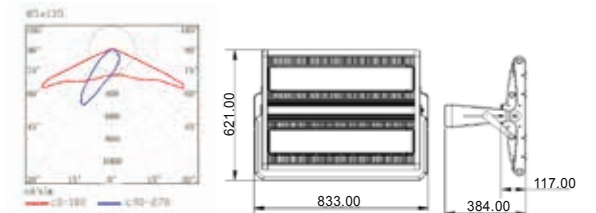

ML4210SBFAO

LED 95 WATTS 10000 LUMENS 5000K Tipo V ANGLULO APERTURA IP65 SATINADO

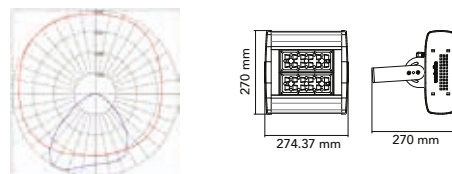

ML4420SBFAO

LED 180 WATTS 19800 LUMENS 5000K Tipo V ANGLULO APERTURA IP65 SATINADO

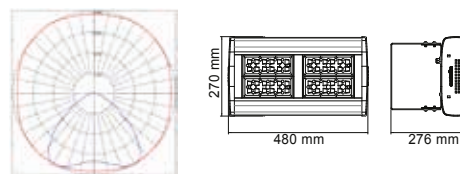

ML4630SBFAO

LED 267 WATTS 29700 LUMENS 5000K 100° ANGLULO APERTURA IP65 SATINADO

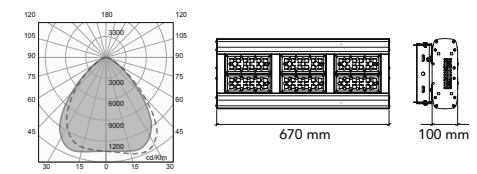

CÓDIGO	MATERIAL DE CUERPO	COLOR	POTENCIA	FLUJO LUMINOSO	ALIMENTACIÓN	TCC	VIDA ÚTIL (L80)	DRIVER	FUENTE DE LUZ	ÁNGULO DE APERTURA (VxH)	IRC	FP	IP	IK	PESO (KG)
OU7103NBFA	Aluminio	■	400 W	35508 lm	127-277 V	5 000 K	50 000 h	Driver electrónico	LED Integrado	80°	65	0.94	65	7	13.2
OU7074NBFA	Aluminio	■	450 W	44200 lm	127-277 V	5 000 K	50 000 h	Driver electrónico	LED Integrado	85x135°	70	0.95	65	7	22
OU7076NBFA	Aluminio	■	670 W	65 780 lm	127-277 V	5 000 K	50 000 h	Driver electrónico	LED Integrado	85 x 135°	70	0.9	65	7	31
ML4210SBFAO	Aluminio	■	95 W	10000 lm	127-277 V	5 000 K	50 000 h	Driver electrónico	LED Integrado	Tipo V	70	0.9	65	8	2.2
ML4420SBFAO	Aluminio	■	180 W	19800 lm	127-277 V	5 000 K	50 000 h	Driver electrónico	LED Integrado	Tipo V	70	0.9	65	8	4
ML4630SBFAO	Aluminio	■	267 W	29700 lm	127-277 V	5 000 K	50 000 h	Driver electrónico	LED Integrado	100°	70	0.9	65	8	6.5

An aerial night photograph of a city, likely Pittsburgh, showing a river, a bridge, and numerous lit-up buildings. Light trails from cars and streetlights create a sense of motion. A large, dark circular overlay covers the left side of the image, containing the text.

LÁMPARAS Y ACCESORIOS

LÁMPARAS LED

- Voltaje Universal (127 - 277 V~)
- Ahorran energía
- Encendido instantáneo
- Vida útil mayor a 25,000 hrs.
- Certificados NOM-ANCE
- Amplitud en Voltajes de alimentación
- Ambientalmente amigables
- Reciclables
- Garantía por 5 años



42752  2700K
AR111 ELEMENTAL



42801  3000K
PAR 30



42800  3000K
PAR 30



42637  3000K
GU10















42753  2700K
T8 ELEMENTAL



42636  3000K
MR16

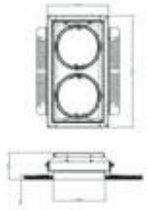

CÓDIGO	COLOR	POTENCIA	FLUJO LUMINOSO	ALIMENTACIÓN	TCC	VIDA ÚTIL (L80)	ÁNGULO DE APERTURA (VxH)	IRC	FP
42752		17 W	1300 lm	127-277 V ~	 2 700 K	25 000 h	24°	90	0.9
42801		30 W	3100 lm	100-277V ~	 3 000 K	25 000 h	30°	90	0.9
42800		30 W	3100 lm	100-277V ~	 3 000 K	25 000 h	30°	90	0.9
42637		6 W	450 lm	127 V ~	 3 000 K	25 000 h	35°	90	0.7
42753		10 W	900 lm	127-277 V ~	 2 700 K	25 000 h	120°	90	0.9
42636		6 W	450 lm	127 V ~	 3 000 K	25 000 h	35°	90	0.7

AC1189N

Open Dark housing doble
Negro / Aluminio Laminado

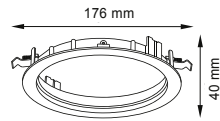
**AC1072B
AC1072N**

Cylinder arillo sencillo
Blanco-Negro / Aluminio

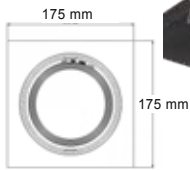
**AC1073N
AC1073B**

Modulare II placa
Negro / Plástico Inyectado

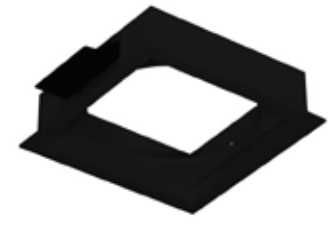
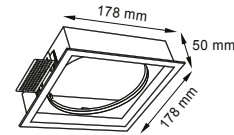
**AC1074B
AC1074N**

Cylinder arillo sencillo
Blanco-Negro / Aluminio

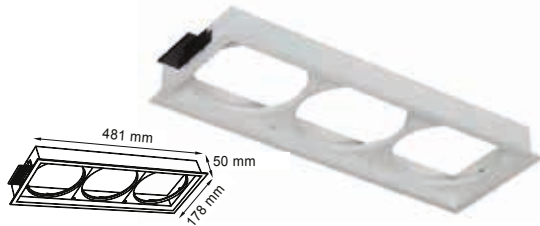
AC1077B

Cylinder placa triple
Blanco-Negro / Aluminio

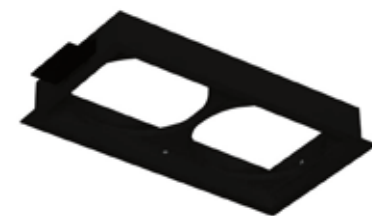
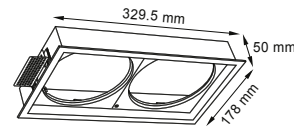
**AC1075B
AC1075N**

Cylinder placa doble
Blanco-Negro / Aluminio

AC4091B

Litepad Acc Sobrep Techo 157x157mm
Blanco / Plástico Inyectado

AC4092B

Litepad Acc Sobrep Techo 180x180mm
Blanco / Plástico Inyectado

AC4093B

Litepad Acc Sobrep Techo 230x230mm
Blanco / Plástico Inyectado

AC4096B

Litepad Acc Sobrep Techo 155x155mm
Blanco / Plástico Inyectado

AC4097B

Litepad Acc Sobrep Techo 180x180mm
Blanco / Plástico Inyectado

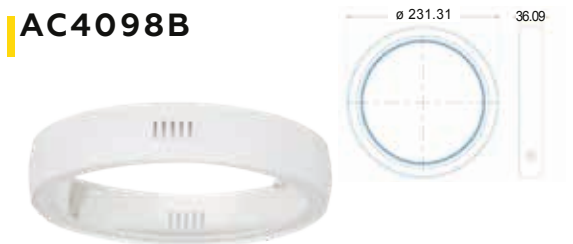
AC4098B

Litepad Acc Sobrep Techo 230x230mm
Blanco / Plástico Inyectado

AC5050N

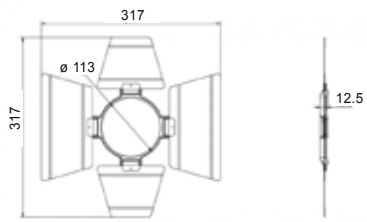

Cubic Pro Aleta
Negro / Aluminio
IK 6 - 0.31 Kg

AC5051B

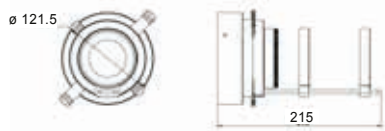

Cubic Pro Aleta
Blanco / Aluminio
IK 6 - 0.49 Kg

AC5052B

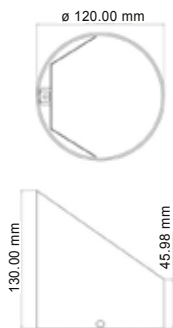

Cubic Pro Viera
Blanco / Aluminio
IK 6 - 0.235 Kg

AC5054N

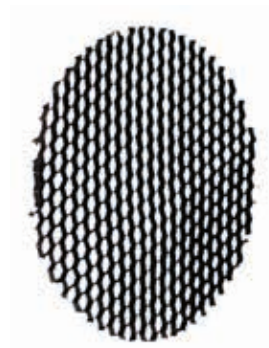
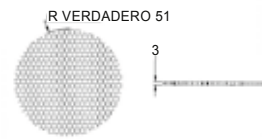

Cubic Pro Panal
Negro / Aluminio
IK 6 - 0.024 Kg

AC5055N

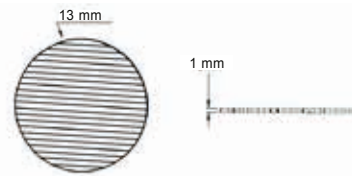

Cubic Pro Difusor
Negro / Vidrio
IK 3 - 0.09 Kg

AC5056N NUEVO

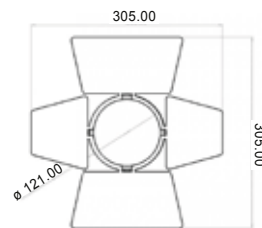

Cylinder Pro Cortador De Luz
Negro / Acero Laminado
IK 6 - 1.7 Kg

AC4050B
AC4050N

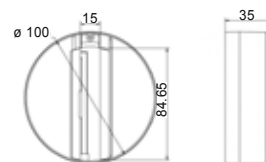

Cubic Pro Canope Riel 3 Fases
Blanco / Negro / Plástico Inyectado
IP 20 - IK 6 - 0.13 Kg

AC5001B
AC5001N

NUEVO

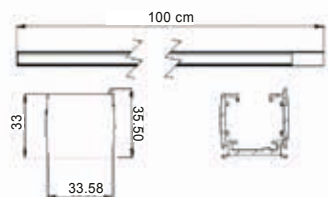

Cylinder Riel 3 Fases controladas **1mt**
Blanco / Negro / Material: Aluminio
IP 40 - IK 6 - 1.5 Kg

AC5002B
AC5002N

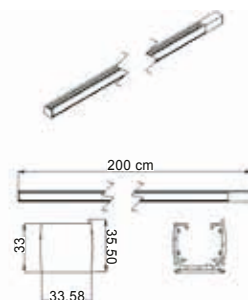

Cylinder Riel 3 Fases controladas **2mt**
Blanco / Negro / Material: Aluminio
IP 40 - IK 6 - 2.3 Kg

AC5003B
AC5003N

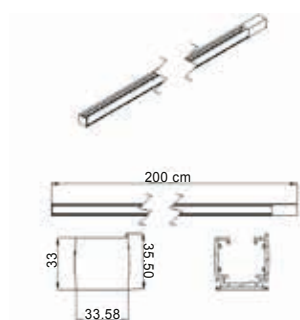

Cylinder Riel Atenuable **2mt**
Blanco / Negro / Material: Aluminio
IP 40 - IK 6 - 2.7 Kg

AC5040B
AC5040N

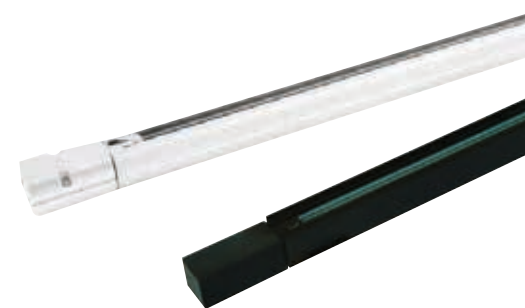
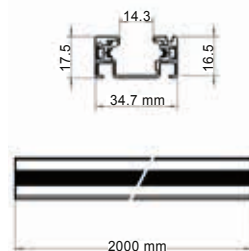

Clas Dirig Riel 1 Fase **2mt**
Blanco / Negro / Material: Aluminio
IP 20 - IK 5 - 1.45 Kg

AC5041B
AC5041N



Clas Dirig Conector Flex
Blanco / Negro / Plástico Inyectado
IK 5 - 0.08 Kg

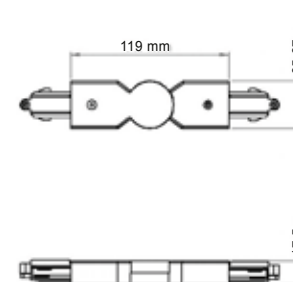

AC6801

NUEVO

*Ideal para Línea Interconectable

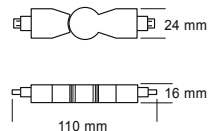

Conector Flexible Horizontal
Blanco / PC
0.022 Kg

AC6802

NUEVO

*Ideal para Línea Interconectable

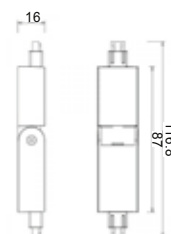

Conector Flexible Vertical
Blanco / PC
0.022 Kg

AC6803

NUEVO

*Ideal para Línea Interconectable

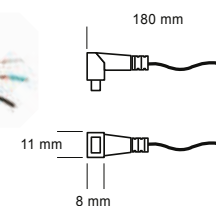

Conector en L
Blanco / PC
0.022 Kg

AC5090N

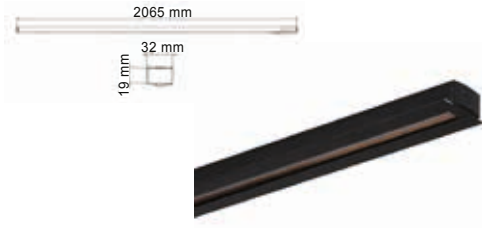

Cylinder Elemental Riel 1 Fase Negro / Aluminio
IP 40 - IK 6 - 1.38 Kg

AC5091N



Conector Recto Riel Elemental Negro / Plástico Inyectado
IP 20 - IK 6 - 0.056 Kg

AC5092N



Conector Flex Riel Elemental Negro / Plástico Inyectado
IP 20 - IK 6 - 0.065 Kg

AC5093N

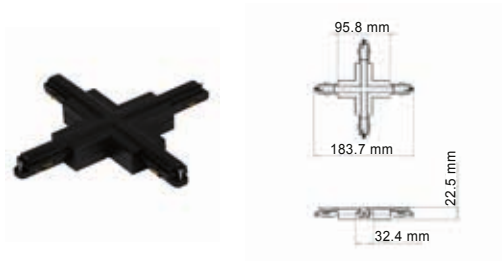

Conector Cruz Riel Elemental Negro / Plástico Inyectado
IP 20 - IK 6 - 0.109 Kg

AC5096N

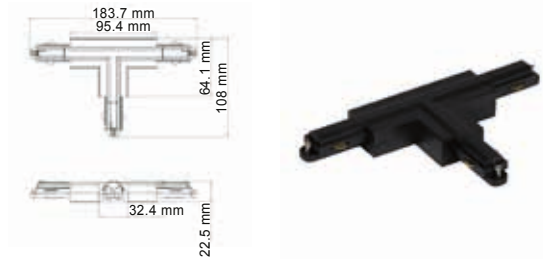

Conector T Der Riel Elemental Negro / Plástico Inyectado
IP 20 - IK 6 - 0.083 Kg

AC5097N

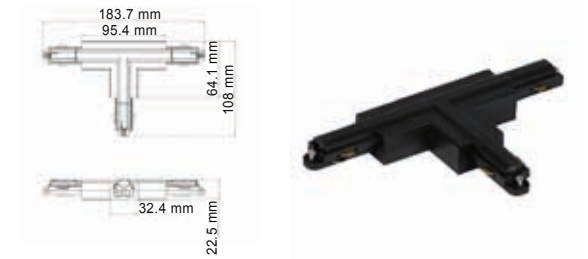

Conector T Izq Riel Elemental Negro / Plástico Inyectado
IP 20 - IK 6 - 0.083 Kg

**AC5430B
AC5430N**

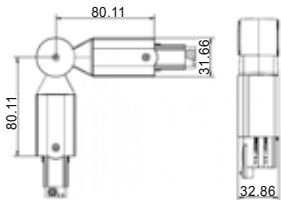

Cylinder Conector Flex Blanco / Negro / Plástico Inyectado
Voltaje: 480 V~
IP 40 - IK 6 - 1 Kg



**AC5431B
AC5431N**



Cylinder Conector Cruz Blanco / Negro / Plástico Inyectado
Voltaje: 480 V~
IP 40 - IK 6 - 0.1 Kg

**AC5432B
AC5432N**

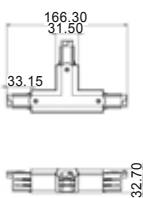

Cylinder Junta Derecha Blanco / Negro / Plástico Inyectado
IP 40 - IK 6 - 0.075 Kg



**AC5433B
AC5433N**

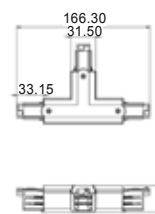

Cylinder Junta Izquierda Blanco / Negro / Plástico Inyectado
IP 40 - IK 6 - 0.075 Kg



AC5501N ■ NUEVO

Riel magnético
Aluminio/Hierro - 1000 x 35 mm
- 1.05 Kg

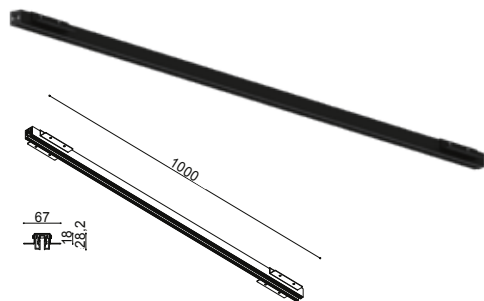
**AC5502N ■ NUEVO**

Riel magnético
Aluminio/Hierro - 2000 x 35 mm
- 1.05 Kg

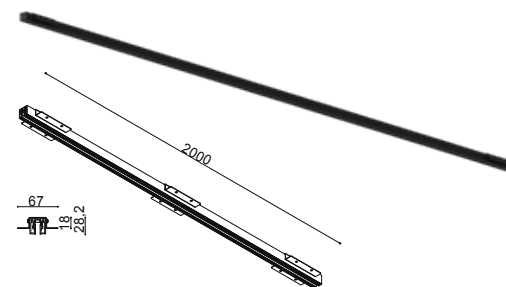
**AC5503N ■ NUEVO**

Riel magnético
Aluminio/Hierro - 2000 x 35 mm
- 1.05 Kg

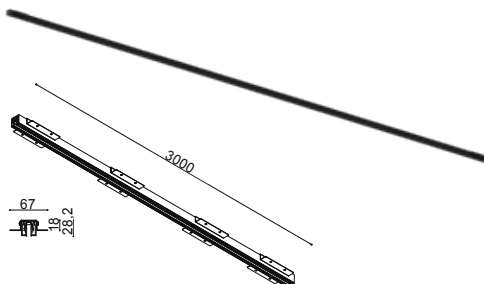
**AC5520N ■ NUEVO**

Conector doble
Aluminio / PC
- 1.05 Kg

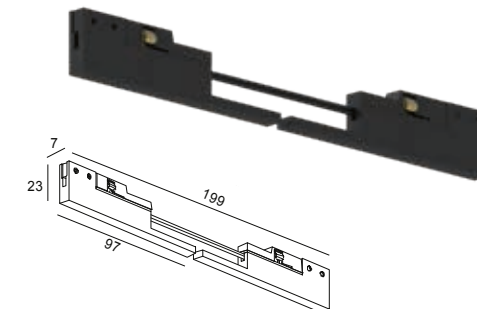
**AC5521N ■ NUEVO**

Conector Sencillo
Aluminio / PC
- 1.05 Kg

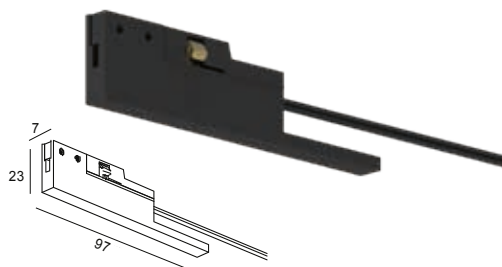
**AC5530N ■ NUEVO**

Tapa final
Aluminio
- 1.05 Kg

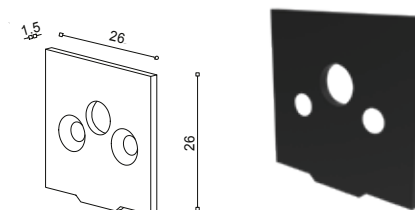
**AC5531N ■ NUEVO**

Conector de rieles
Aluminio
- 1.05 Kg

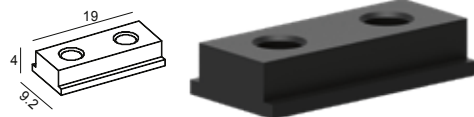
**AC5510N ■ NUEVO**

Conector tipo codo
Aluminio
- 1.05 Kg

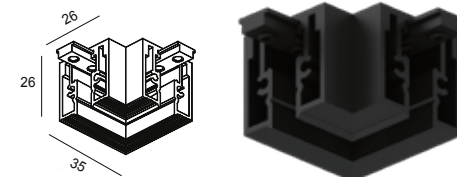
**AC5511N ■ NUEVO**

Conector tipo codo
Aluminio
- 1.05 Kg

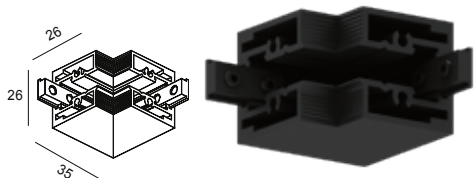
**AC5512N ■ NUEVO**

Conector tipo codo
Aluminio
- 1.05 Kg

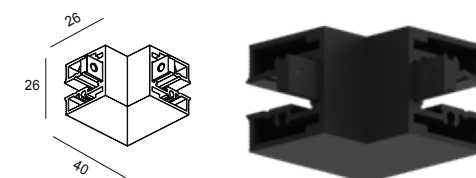

AC4013N

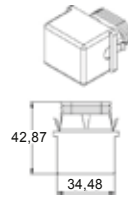

Fragata Conector
Negro / Aluminio Inyectado
IP 68 - 0.1 Kg

AC4040N

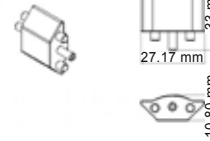

Stripline Conector Recto T26
Negro / Plástico Inyectado
IP 10 - IK 7 - 0.1 Kg

AC4041N



Stripline Conector Angulado T26
Negro / Plástico Inyectado
IP 10 - IK 7 - 0.1 Kg

AC6800

*Ideal para Línea Interconectable

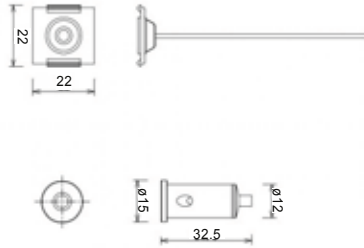

Sistema de suspensión
1.5 m longitud



AC8101BBNA

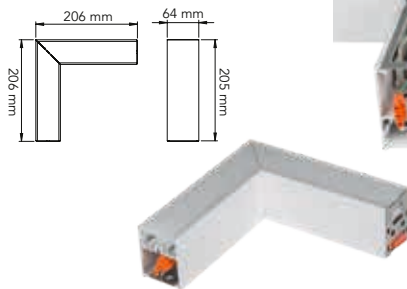

Slim Pro Conector L
Aluminio Extruido
Voltaje: 127-277 V~ Watts: 12 W
IP 40 - IK 4 - 0.2 Kg

AC8102BBNA

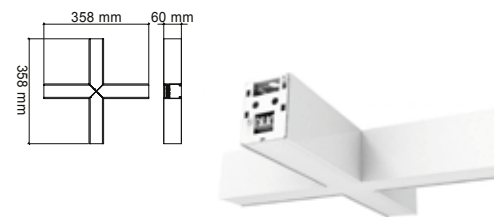

Slim Pro Conector X
Aluminio Extruido
Voltaje: 127-277 V~ Watts: 23 W
IP 40 - IK 4 - 0.2 Kg

AC8103BBNA

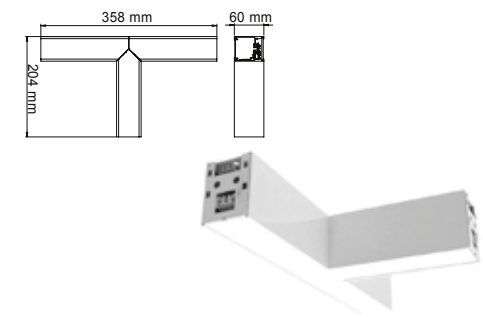

Slim Pro Conector T
Aluminio Extruido
Voltaje: 127-277 V~ Watts: 16 W
IP 40 - IK 4 - 0.2 Kg

AC8110N

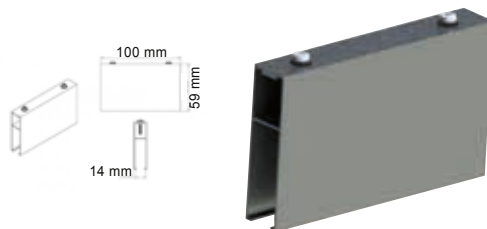

Trazzo Conector Recto Para CO8111NBNA
Aluminio
IK 7 - 0.6 Kg

AC8111N

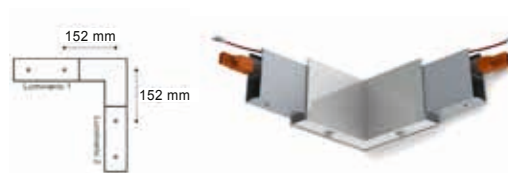

Trazzo Conector 90º Para CO8111NBNA
Aluminio
IK 7 - 0.6 Kg

AC8312B00K

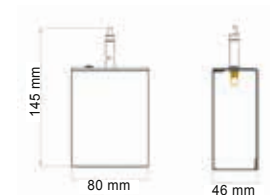

Trazzo Conector Tandem
Aluminio
IK 7 - 0.2 Kg

AC4251BBCA
 AC4251BBNA
 AC4251NBCA
 AC4251NBNA

NUEVO

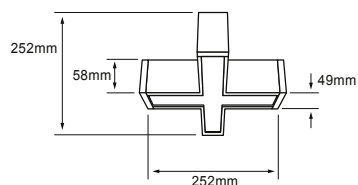
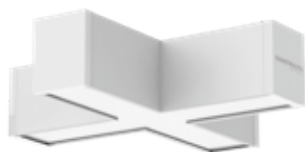

Luminario conector en X
 Aluminio / Plástico
 - 1.05 Kg

AC4252BBCA
 AC4252BBNA
 AC4252NBCA
 AC4252NBNA

NUEVO

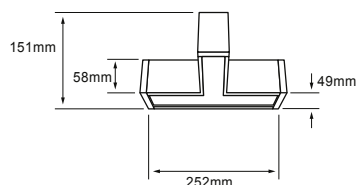

Luminario Conector T
 Aluminio / Plástico
 - 1.05 Kg

AC4253BBCA
 AC4253BBNA
 AC4253NBCA
 AC4253NBNA

NUEVO

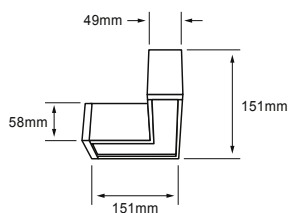

Luminario Conector L
 Aluminio / Plástico
 - 1.05 Kg

AC8254S

NUEVO

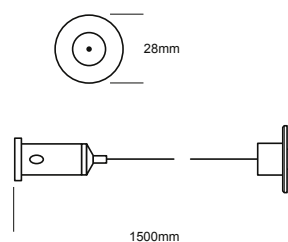

Accesorio para suspensión
 Aluminio / Plástico
 Incluye 2 piezas
 - 1.05 Kg

AC1255S

NUEVO

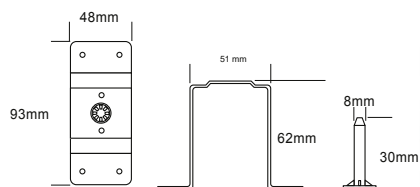

Accesorio para empotrar
 Satinado
 Incluye 2 piezas

AC4256S

NUEVO

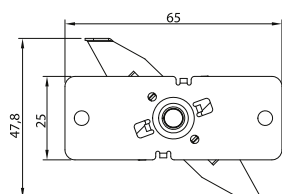

Accesorio para sobreponer
 Satinado
 Incluye 2 piezas

AC2200S

NUEVO



Perfil Aluminio Emp Muro/Techo 3mts.
Satin / Aluminio
- 1.554 Kg

AC3200S

NUEVO



Perfil Aluminio Emp Piso 3mts.
Satin / Aluminio
IP 65 - 1.838 Kg

AC3211S

NUEVO



Perfil Aluminio Emp Esquina Ext 3mts..
Satin / Aluminio
- 1.762 Kg

AC6200S

NUEVO



Perfil Aluminio Sobrep Muro/Techo 3 Mts
Satinado / Aluminio
1.446 Kg

AC6210S

NUEVO



Perfil Aluminio Sobrep Esquina 3mts
Satinado / Aluminio
2.292 Kg

AC8201S

NUEVO



Perfil Aluminio Closet 3mts
Aluminio
1.49 Kg

AC8200S

NUEVO



Perfil Aluminio Suspendido 3mts
Aluminio
Voltaje: 100-277 V-
0.93 Kg

AC3210S

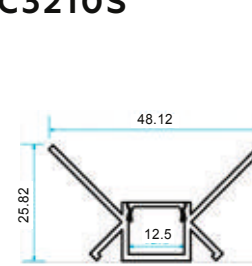

Perfil Aluminio Esquinero 3mts
Aluminio
Ancho 45.5mm Alto 25mm
Empotrar

AC6201**NUEVO**

Accesorio para Perfil AC6200S
Satinado / Plastico - Aluminio

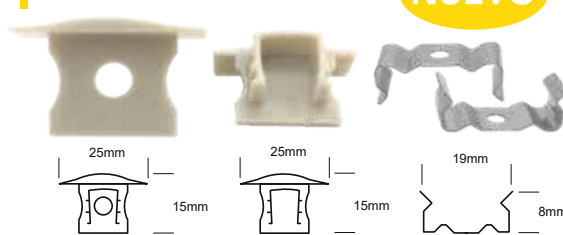
AC2201**NUEVO**

Accesorio para Perfil AC2200S
Satinado / Plastico - Aluminio

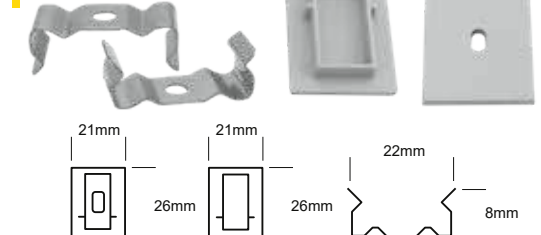
AC3201

Accesorio para Perfil AC3200S
Satinado / Plástico - Aluminio

AC8202**NUEVO**

Accesorio para Perfil AC8200S
Satinado / Plastico - Aluminio

AC3209**NUEVO**

Accesorio para Perfil AC3210S
Satinado / Plastico - Aluminio

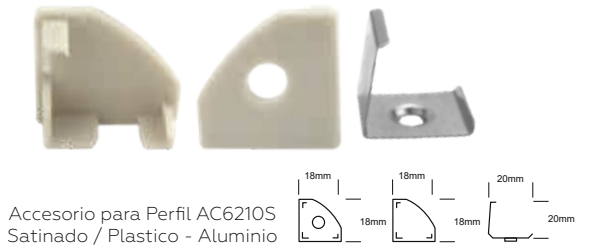
AC6211**NUEVO**

Accesorio para Perfil AC6210S
Satinado / Plastico - Aluminio

AC8203**NUEVO**

Accesorio para Perfil AC8201S
Satinado / Plastico - Aluminio

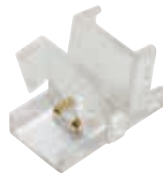
AC6043B**NUEVO**

Conector I Exterior
PC / PC
IP 66

AC3212**NUEVO**

Accesorio para Perfil AC3211S
Satinado / Plastico - Aluminio

AC6036B**NUEVO**

Grapa Para Instalacion Tira Led Int
Silicon / Silicon

AC6037B**NUEVO**

Conector X Interior (Cortable)
PI / PI

AC6038N**NUEVO**

Conector Multiple 8-Canales Tira Driver
PVC / PVC
IP 20

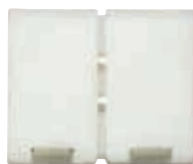
AC6039B**NUEVO**

Conector I
PC / PC
IP 20

AC6040B**NUEVO**

Extension Conector I
PVC / PVC
IP 20

AC6042B**NUEVO**

Tapa Final Exterior
Silicon / Silicon
IP 66

AC7105S

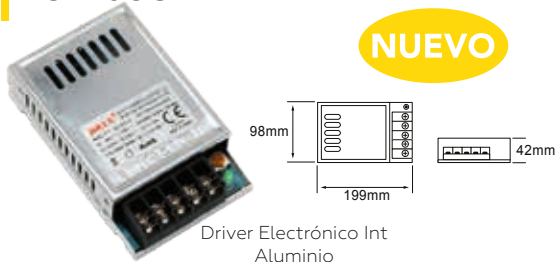

NUEVO

Driver Electrónico Int
Aluminio
Voltaje: 100-277 V~ Watts: 15 W
IP 20 - 0.063 Kg - Voltaje de salida: 24V

AC7106S



NUEVO

Driver Electrónico Int
Aluminio
Voltaje: 100-277 V~ Watts: 60 W
IP 20 - 0.356 Kg - Voltaje de salida: 24 V

AC7107S

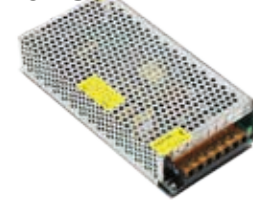

NUEVO

Driver Electrónico Int
Aluminio
Voltaje: 100-277 V~ Watts: 100 W
IP 20 - 0.455 Kg - Voltaje de salida: 24 V

AC7108S

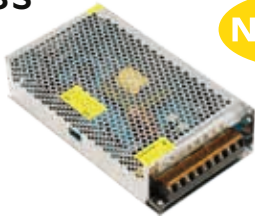

NUEVO

Driver Electrónico Int
Aluminio
Voltaje: 100-277 V~ Watts: 180 W
IP 20 - 0.575 Kg - Voltaje de salida: 24V

AC7109S



NUEVO

Driver Electrónico Int
Aluminio
Voltaje: 100-277 V~ Watts: 300 W
IP 20 - 0.783 Kg - Voltaje de salida: 24 V

AC7110S

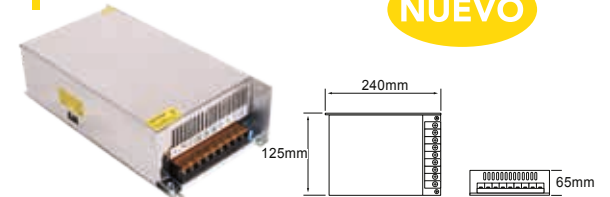

NUEVO

Driver Electrónico Int
Aluminio
Voltaje: 100-277 V~ Watts: 500 W
IP 20 - 1.385 Kg - Voltaje de salida: 24 V

AC7200S



Stripline Driver Electrónico
Satinado / Aluminio
Voltaje: 127-220 V~ Watts: 200 W
IP 65 - IK 7 - 1.35 Kg
Voltaje de salida: 24V

AC7505G

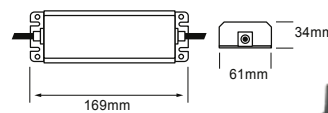

NUEVO

Driver Electrónico
Gris / Aluminio
Voltaje: 100-277 V~ Watts: 60 W
IP 67 - 0.6 Kg
Voltaje de salida: 24V

AC7515B

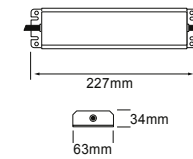

NUEVO

Driver Electrónico Ext
Satinado / Aluminio
Voltaje: 100-277 V~ Watts: 150 W
IP 67 - 0.7 Kg
Voltaje de salida: 24V

AC7525B

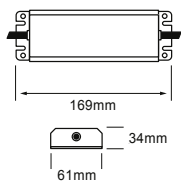

NUEVO

Driver Electrónico Ext
Satinado / Aluminio
Voltaje: 100-277 V~ Watts: 250 W
IP 67 - 0.9 Kg
Voltaje de salida: 24V

AC7050N

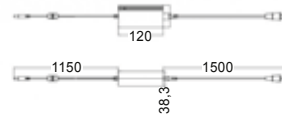

Driver Electrónico para STRIP LINES
Blanco / Aluminio
Voltaje: 127-220 V~ Watts: 50 W
IP 20 - IK 7 - 0.33 Kg
Voltaje de salida: 24V

AC7002N



Driver
Voltaje: 100-277 V~ Watts: 75 W
IP 20 - IK 7 - 0.33 Kg
Voltaje de salida: 24V

AC7018B



Driver Electrónico para STRIP LINES
Blanco / Aluminio
Voltaje: 127-240 V~ Watts: 18 W
IP 20 - IK 7 - 0.15 Kg
Voltaje de salida: 12V

AC7100S

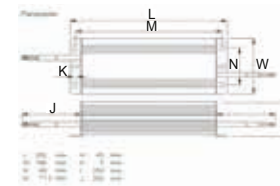

Stripline Driver Electrónico
Aluminio / Aluminio
Voltaje: 127-220 V~ Watts: 100 W
IP 20 - IK 7 - 1.2 Kg
Voltaje de salida: 12V

AC7300N

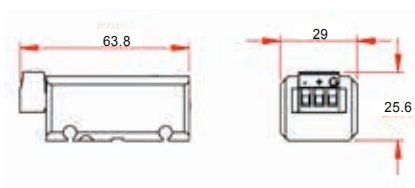

Controlador Dmx
Negro / Aluminio
Voltaje: 5 V- Watts: 2 W
IP 20 - IK 7 - 0.1 Kg



AC8090N

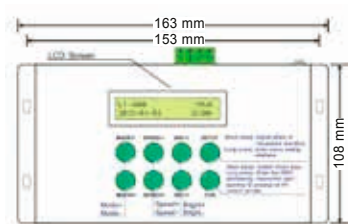

Equipo Dmx Controlador Rgb
Negro / Acero
Voltaje: 127-220 V- Watts: 2 W
IP 20- IK 7 - 0.3 Kg

AC8091N

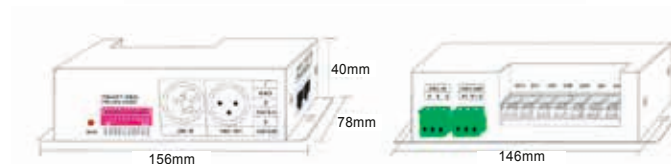

Equipo Dmx Controlador Rgb
Negro / Acero
Voltaje: 5 V- Watts: 216 W
IP 20- IK 7 - 706.512 Kg

AC8092N

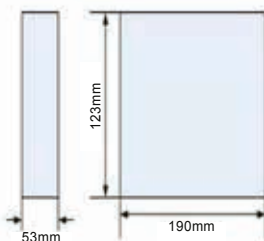

Equipo Dmx Controlador Rgb
Negro / Acero
Voltaje: 127-220 V- Watts: 5 W
IP 20- IK 7 - 1 Kg

AC8093N



Equipo Dmx Decodificador Rgbw
Negro / Acero
Voltaje: 5 V- Watts: 480 W
IP 20- IK 7 - 1 Kg

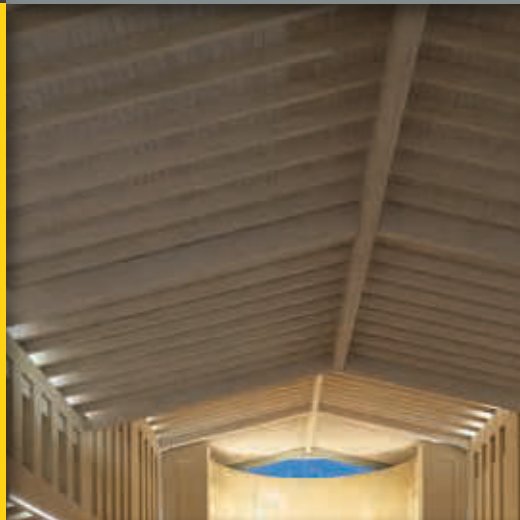

CONSTRULITA[®]

EL SENTIDO DE LA LUZ

¡SÍGUE NUESTRAS REDES SOCIALES!



CONSTRULITA[®]

EL SENTIDO DE LA LUZ

www.construlitalighting.com

